

Roland Authorized Accessories

Effective 08/28/06

Jewelry Model Makers

JWX-10 (CNC jewelry milling machine w/ 4 th Axis)	\$9,995
--	----------------

Precision Jewelry model making machine compatible with Gemvision Matrix, Type 3 3D Design, ArtCAM Jewel Smith, Rhino using industry standard .stl file format.



Collets

ZC-23-3175	(Bottom Load 1/8" Collet, Inc. w/ JWX-10, MDX-40)	\$38.99
ZC-23-635	(Bottom Load 1/4" Collet, Inc. w/ JWX-10)	\$38.99
ZC-23-6	(Bottom Load 6mm Collet)	\$38.99
ZC-23-3	(Bottom Load 3mm Collet)	\$38.99
ZC-23	(Bottom Load 3mm, 4mm, 5mm, 6mm Collet Set)	\$179.99
ZC-E436	(Engraving Collet, Inc. w/ JWX-10)	\$29.99

Collets hold tools firmly in machines spindle



Top Loading Profiler Tools (High Speed Steel)

ZEC-J4012-7	(11/64" Shank, 7.5°, 0.12mm Tip, 130mm Overall Length)	\$26.99
ZEC-J4025-7	(11/64" Shank, 7.5°, 0.25mm Tip, 130mm Overall Length)	\$26.99
ZEC-J4100-7	(11/64" Shank, 7.5°, 1.00mm Tip, 130mm Overall Length)	\$26.99

Top loading cutters are easy to install and uninstall from the top of spindle.

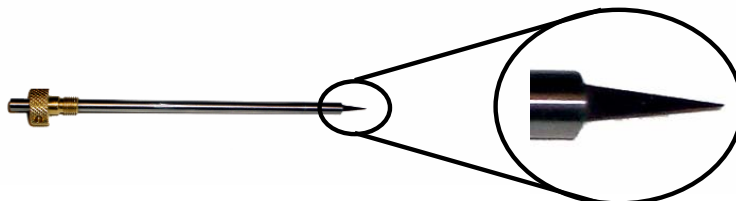

Bottom Loading Tooling (High Speed Steel)

EMP-KIT	(Contains (1) 0.003", (3) 0.005", (1) EMF-125-1F-125)	\$95
EMP-125-003	(End Mill Profiler, 7.5°, .125" Shank, .003" Tip)	\$18
EMP-125-005	(End Mill Profiler, 7.5°, .125" Shank, .005" Tip)	\$18
EMF-125-1F-125	(End Mill Flat, .125" Shank, 1 Flute, .125" Tip)	\$25

Bottom loading cutters are less expensive and load from bottom of spindle.

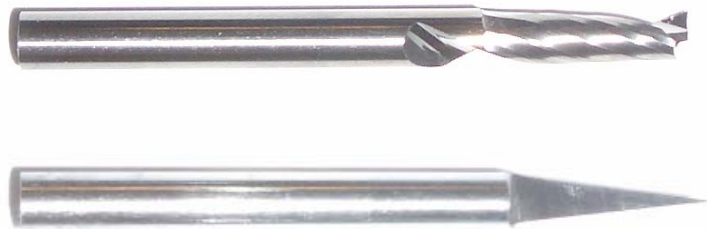

ProtoWizard Kit

PW-PWSRFX-KIT (Software, Ring Fixture Kit, New Fixtures)	\$2,250
--	----------------

Hardware fixture and CAM software optimized for jewelry model making. Easy to use wizard based interface walks you through the model making creation.

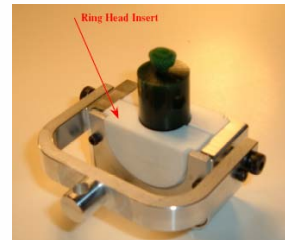
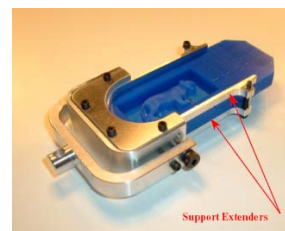

ProtoWizard Additional Fixtures

PW-XTRAFIX (Extension Adaptors, Insert Adaptor, Rotary Unit)	\$250
--	--------------

For ProtoWizard Rev. 1 users who do not have the above additional fixtures.

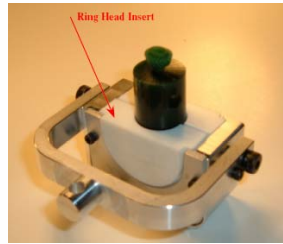
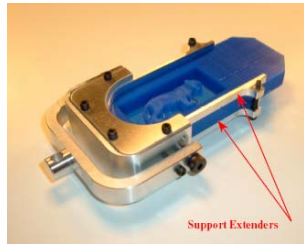

ProtoWizard Material

PW-WAX-KIT	(ProtoWizard Wax Starter Kit)	\$35
PW-10-10	(10.5mm discs, 27 pieces)	\$25
PW-10-15	(15.5mm discs, 18 pieces)	\$25
PW-10-20	(20.5mm discs, 15 pieces)	\$25
PW-10-25	(25.5mm discs, 12 pieces)	\$25
PW-20-516	(1 5/16" OD, 5/8" ID Ring Tube, 6" Length, 1 piece)	\$6.25
PW-20-78	(7/8" Dia. Rod, 6" Length, 1 piece)	\$6.25
PW-30-5	(5.5mm Tablets, 8 pieces)	\$12
PW-30-10	(10.5mm Tablets, 4 pieces)	\$12

Wizard wax material optimized for use with Roland Mills and ProtoWizard hardware. Cuts clean and smooth without the need for cutting fluids.



Diamond Scribing Tools

BT-EGX3-125	(High Precision Spring Loaded Burnishing Adaptor)	\$129.99
C2-125-DGK	(Diamond Scribing Tool, 5" length, 1/8" Dia.)	\$24.00
21655108	(Top Loading 1/8" Guide Collet)	\$53.16
AS-10	(Adhesive Sheet Hold Down System, pkg. of 10)	\$34.99

Gives you the ability to diamond scribe on a wide variety of materials



Self Centering Clamp

21765129 (Self centering vise)	\$1,390.20
--------------------------------	-------------------

Self centering clamp for use with the JWX-10.

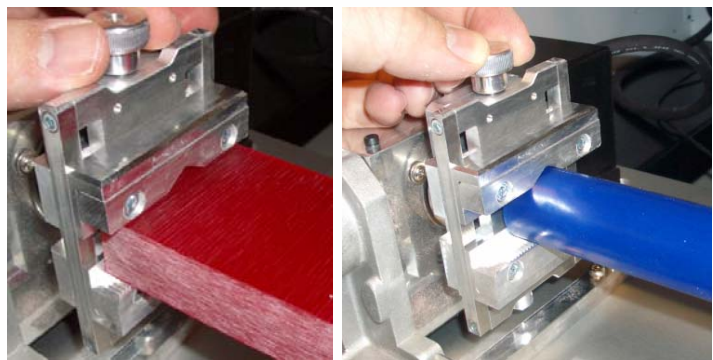
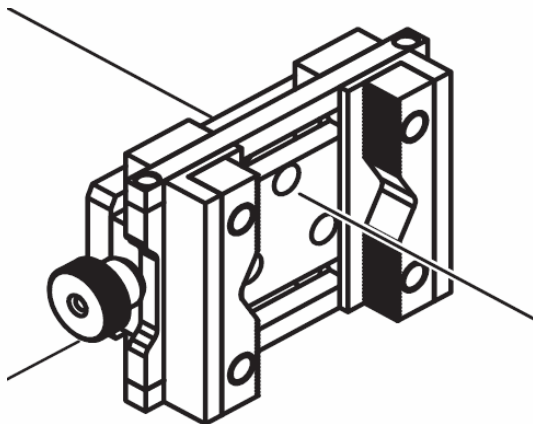

Extended Warranty

Additional 1 Year Warranty Coverage (Diamond Plate)	\$925
Additional 2 Years Warranty Coverage (Three Years Coverage)	\$1,850
Additional 3 Years Warranty Coverage (Four Years Coverage)	\$2,775

Additional coverage covers the machine for parts, labor and shipping of unit one way if necessary.

