

# ***EGX-30A***

## ***DESKTOP ENGRAVER***

### ***USER'S MANUAL***

- 
- To ensure safe usage and full performance of this product, please be sure to read through this manual completely.
  - To ensure immediate access whenever needed, store this manual in a safe location.
  - Unauthorized copying, quotation, or translation of this manual, in whole or in part, without the written approval of Roland DG Corp., is prohibited.
  - The contents of this document and the specifications of this product are subject to change without notice.
  - Roland DG Corp. assumes no responsibility for any loss or damage relating to this product, regardless of any defect in this product or this manual. Such loss or damage, whether direct or indirect, includes, but is not limited to, that arising from the specifications or performance of this product, that due to failure of the product to perform, and that arising from any article made using this product.
-

**For the USA**

**FEDERAL COMMUNICATIONS COMMIS-  
SION RADIO FREQUENCY INTERFERENCE  
STATEMENT**

This equipment has been tested and found to comply with the limits for a Class A digital device, pursuant to Part 15 of the FCC Rules.

These limits are designed to provide reasonable protection against harmful interference when the equipment is operated in a commercial environment.

This equipment generates, uses, and can radiate radio frequency energy and, if not installed and used in accordance with the instruction manual, may cause harmful interference to radio communications.

Operation of this equipment in a residential area is likely to cause harmful interference in which case the user will be required to correct the interference at his own expense.

-----  
Unauthorized changes or modification to this system can void the users authority to operate this equipment.

When the equipment requires a usb cable, it must be shielded type.

**For Canada**

**CLASS A NOTICE**

This Class A digital apparatus meets all requirements of the Canadian Interference-Causing Equipment Regulations.

**CLASSE A AVIS**

Cet appareil numérique de la classe A respecte toutes les exigences du Règlement sur le matériel brouilleur du Canada.

**For California**

**WARNING**

This product contains chemicals known to cause cancer, birth defects and other reproductive harm, including lead.

**For EU Countries**



**Manufacturer:**

**ROLAND DG CORPORATION**

**1-6-4 Shinmiyakoda, Kita-ku, Hamamatsu-shi, Shizuoka-ken, 431-2103 JAPAN**

**The authorized representative in the EU:**

**Roland DG Corporation, German Office Halskestr. 7, 47877 Willich, Germany**

**WARNING**

This is a Class A product. In a domestic environment this product may cause radio interference in which case the user may be required to take adequate measures.

Roland DG Corp. has licensed the MMP technology from the TPL Group.

# Table of Contents

Table of Contents .....	1
 <b>To Ensure Safe Use .....</b>	<b>3</b>
<b>Important Notes on Handling and Use .....</b>	<b>9</b>
<b>Chapter 1 Getting Started .....</b>	<b>11</b>
1-1 Great Features .....	12
Engraving - ENGRAVER .....	12
Scoring - SCORE .....	12
1-2 Part Names and Functions .....	13
Front .....	13
Rear .....	13
Control Panel .....	14
<b>Chapter 2 Installation and Setup .....</b>	<b>15</b>
2-1 Checking the Included Items .....	16
2-2 Installation .....	17
Installation Environment .....	17
Unpacking .....	19
2-3 Cable Connections .....	20
Connecting the Power Cord .....	20
Connecting to the Computer .....	21
2-4 Installing and Setting Up the Software .....	22
System Requirements .....	22
The Software You Can Install and Set Up .....	22
Installing the Windows-based Driver .....	23
Installing the Software ( Dr. Engrave ) .....	24
<b>Chapter 3 Getting Ready for and Performing Cutting .....</b>	<b>25</b>
3-1 Switching the Power On and Off .....	26
Switching On the Power .....	26
Switching Off the Power .....	26
3-2 Before Starting to Cut .....	27
Loading the Material .....	27
3-3 Installing a Tool .....	28
For Engraving (Character Cutter) .....	28
How to Remove the Cutter for Engraving .....	30
How to Remove the Depth Regulator Nose .....	31
For the Scoring (Diamond scraper) .....	31
Setting the Origin Point .....	33
About Tools and Materials .....	33
Test Cutting .....	34
3-4 Setting Cutting Conditions .....	35
Spindle Speed .....	35
Cutting Speed .....	35
Attaching the Vacuum-adaptor for Chip Cleaning .....	36
3-5 Sending Cutting Data .....	37
Sending Cutting Data .....	37
Changes That Can Be Made While Cutting .....	37
3-6 Ending Cutting Operations .....	38
Ending Cutting Operations .....	38
<b>Chapter 4 Appendix .....</b>	<b>39</b>
4-1 Maintenance .....	40

## Table of Contents

---

Cleaning.....	40
Replacing the Bearing for the Depth Regulator Nose .....	41
Replacement of Spindle Belt.....	41
4-2 What to Do If.....	42
4-3 Power Rating and Serial Number Locations .....	44
4-4 Interface Specifications.....	45
Serial Connector .....	45
4-5 Appendix .....	46
List of Options.....	46
Instruction Support Chart.....	47
Main Specifications.....	48
System Requirements for USB Connection.....	48
Please read this agreement before unpacking the media .....	IV

Company names and product name are trademarks or registered trademarks of their respective holders.



Copyright © 2008-2010 Roland DG Corporation

<http://www.rolanddg.com/>







# To Ensure Safe Use

Improper handling or operation of this machine may result in injury or damage to property. Points which must be observed to prevent such injury or damage are described as follows.

## About WARNING and CAUTION Notices

 <b>WARNING</b>	Used for instructions intended to alert the user to the risk of death or severe injury should the unit be used improperly.
 <b>CAUTION</b>	Used for instructions intended to alert the user to the risk of injury or material damage should the unit be used improperly.  Note: Material damage refers to damage or other adverse effects caused with respect to the home and all its furnishings, as well to domestic animals or pets.

## About the Symbols

	The  symbol alerts the user to important instructions or warnings. The specific meaning of the symbol is determined by the design contained within the triangle. The symbol at left means "danger of electrocution."
	The  symbol alerts the user to items that must never be carried out (are forbidden). The specific thing that must not be done is indicated by the design contained within the circle. The symbol at left means the unit must never be disassembled.
	The  symbol alerts the user to things that must be carried out. The specific thing that must be done is indicated by the design contained within the circle. The symbol at left means the power-cord plug must be unplugged from the outlet.

 **Incorrect operation may cause injury.**

 **WARNING**

 **Be sure to follow the operation procedures described in this documentation. Never allow anyone unfamiliar with the usage or handling of the machine to touch it.**  
Incorrect usage or handling may lead to an accident.

 **Keep children away from the machine.**  
The machine includes areas and components that pose a hazard to children and may result in injury, blindness, choking, or other serious accident.

 **Never operate the machine while tired or after ingesting alcohol or any medication.**  
Operation requires unimpaired judgment. Impaired judgment may result in an accident.

 **Conduct operations in a clean, brightly lit location.**  
Working in a location that is dark or cluttered may lead to an accident, such as becoming caught in the machine as the result of an inadvertent stumble.

 **Never use the machine for any purpose for which it is not intended, or use the machine in an undue manner that exceeds its capacity.**  
Doing so may result in injury or fire.

 **Never use a cutting tool that has become dull. Perform frequent maintenance to keep and use the machine in good working order.**  
Unreasonable usage may result in fire or injury.

 **For accessories (optional and consumable items, power cord, and the like), use only genuine articles compatible with this machine.**  
Incompatible items may lead to an accident.

 **WARNING**

 **Before attempting cleaning, maintenance, or attachment or detachment of optional items, disconnect the power cord.**  
Attempting such operations while the machine is connected to a power source may result in injury or electrical shock.

 **Never attempt to disassemble, repair, or modify the machine.**  
Doing so may result in fire, electrical shock, or injury. Entrust repairs to a trained service technician.

 **CAUTION**

 **Never climb or lean on the machine.**  
The machine is not made to support a person. Climbing or leaning on the machine may dislodge components and cause a slip or fall, resulting in injury.

 **Install in a location that is level and stable.**  
Installation in an unsuitable location may cause an accident, including a fall or tipover.

 **The cutting waste or workpiece may catch fire or pose a health hazard.**

 **WARNING**

 **Never attempt to cut magnesium or any other such flammable material.**  
Fire may occur during cutting.

 **Keep open flame away from the work area.**  
Cutting waste may ignite. Powdered material is extremely flammable, and even metal material may catch fire.

 **When using a vacuum cleaner to take up cutting waste, exercise caution to prevent fire or dust explosion.**  
Taking up fine cuttings using an ordinary vacuum cleaner may cause danger of fire or explosion. Check with the manufacturer of the vacuum cleaner. When the safety of use cannot be determined, clean using a brush or the like, without using the vacuum cleaner.

 **CAUTION**

 **Wear dust goggles and a mask. Wash away any cutting waste remaining on the hands.**  
Accidentally swallowing or inhaling cutting waste may be hazardous to the health.

 **Danger of pinching, entanglement, and burns.**

 **WARNING**

 **Never attempt operation while wearing a necktie, necklace, loose clothing, or gloves. Bind long hair securely.**  
Such items may become caught in the machine, resulting in injury.

 **Securely fasten the cutting tool and workpiece in place. After securing in place, make sure no wrenches or other articles have inadvertently been left behind.**  
Otherwise such articles may be thrown from the machine with force, posing a risk of injury.

 **WARNING**

 **Exercise caution to avoid being pinched or becoming caught.**  
Inadvertent contact with certain areas may cause the hand or fingers to be pinched or become caught. Use care when performing operations.

 **Caution: cutting tool.**  
The cutting tool is sharp. To avoid injury, exercise caution.

 **Caution: high temperatures.**  
The cutting tool and spindle motor become hot. Exercise caution to avoid fire or burns.

**⚠ Danger of electrical short, shock, electrocution, or fire**

**⚠ WARNING**

**!** **Connect to an electrical outlet that complies with this machine's ratings (for voltage, frequency, and current).** Incorrect voltage or insufficient current may cause fire or electrical shock.

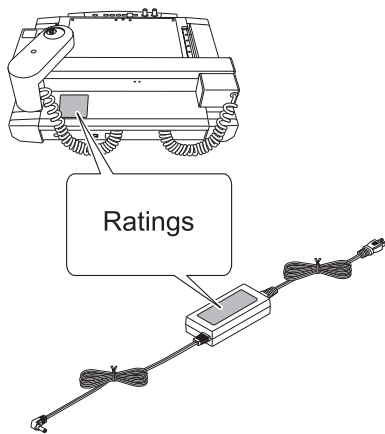

**⊘** **Do not use with any power supply other than the dedicated AC adapter.** Use with any other power supply may lead to fire or electrocution.

**⊘** **Never use out of doors or in any location where exposure to water or high humidity may occur. Never touch with wet hands.** Doing so may result in fire or electrical shock.

**⊘** **Never allow any foreign object to get inside. Never expose to liquid spills.** Inserting objects such as coins or matches or allowing beverages to be spilled into the ventilation ports may result in fire or electrical shock. If anything gets inside, immediately disconnect the power cord and contact your authorized Roland DG Corp. dealer.

**⚠ WARNING**

**⊘** **Never place any flammable object nearby. Never use a combustible aerosol spray nearby. Never use in any location where gases can accumulate.** Combustion or explosion may be a danger.

**!** **Handle the power cord, plug, and electrical outlet correctly and with care. Never use any article that is damaged.** Using a damaged article may result in fire or electrical shock.

**!** **When using an extension cord or power strip, use one that adequately satisfies the machine's ratings (for voltage, frequency, and current).** Use of multiple electrical loads on a single electrical outlet or of a lengthy extension cord may cause fire.

**!** **When the machine will be out of use for a prolonged period, disconnect the power cord.** This can prevent accidents in the event of current leakage or unintended startup.

**!** **Position so that the power plug is within immediate reach at all times.** This is to enable quick disconnection of the power plug in the event of an emergency. Install the machine next to an electrical outlet. Also, provide enough empty space to allow immediate access to the electrical outlet.

**⊘** **Never use cutting oil.** This machine is not designed for the flow of cutting oil. Oil may get inside the machine and cause fire or electrical shock.

**⊘** **Never use a pneumatic blower.** This machine is not compatible with a pneumatic blower. Cutting waste may get inside the machine and cause fire or electrical shock.

**!** **If sparking, smoke, burning odor, unusual sound, or abnormal operation occurs, immediately unplug the power cord. Never use if any component is damaged.** Continuing to use the machine may result in fire, electrical shock, or injury. Contact your authorized Roland DG Corp. dealer.



---

⚠ Important notes about the power cord, plug, and electrical outlet

---

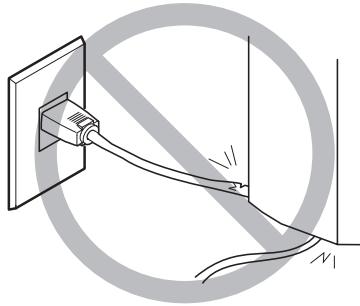

Never place any object on top or subject to damage.

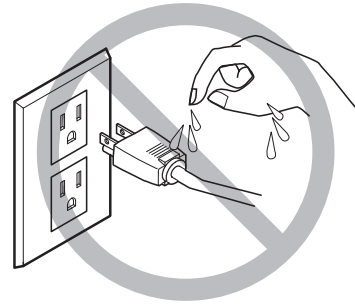

Never allow to get wet.

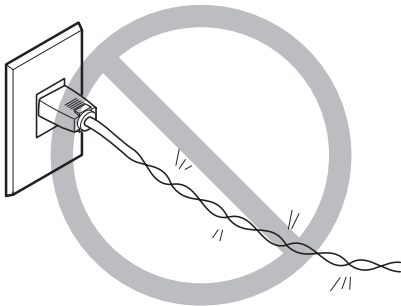

Never bend or twist with undue force.

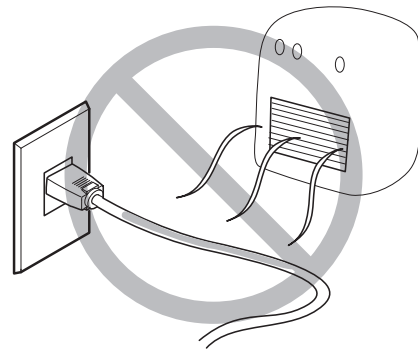

Never make hot.

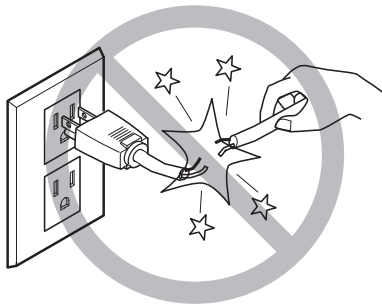

Never pull with undue force.

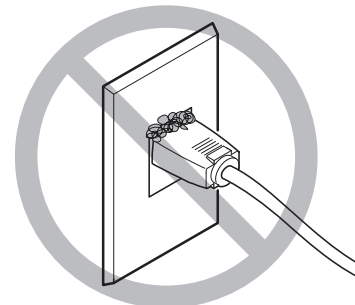

Dust may cause fire.

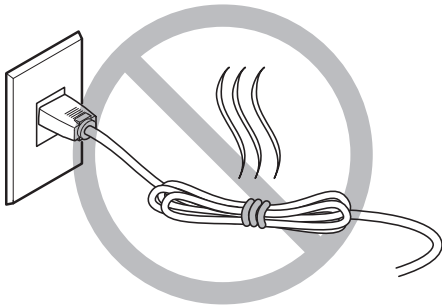

Never bundle, bind, or roll up.

## Warning Labels

Warning labels are affixed to make areas of danger immediately clear. The meanings of these labels are as follows. Be sure to heed their warnings.

Also, never remove the labels or allow them to become obscured.

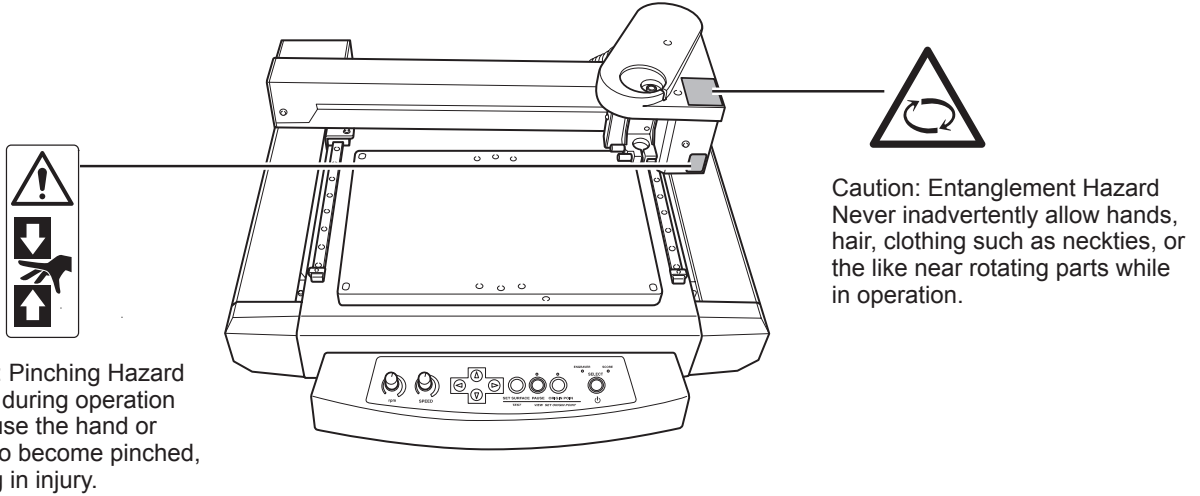

# Important Notes on Handling and Use

---

This machine is a precision device. To ensure the full performance of this machine, be sure to observe the following important points. Failure to observe these may not only result in loss of performance, but may also cause malfunction or breakdown.

## ***This machine is a precision device.***

---

---

- Handle carefully, and never subject the machine to impact or excessive force.
- Diligently keep clean of cutting waste.
- Use within the range of specifications.
- Never attempt to move the tool carriage by hand with undue force.
- Never needlessly touch anywhere inside the machine except for locations specified in this manual.

## ***Install in a suitable location.***

---

---

- Install in a location that meets the specified conditions for temperature, relative humidity, and the like.
- Install in a quiet, stable location offering good operating conditions.
- Never install in out of doors.
- Never use the machine in an environment where silicone substances (oil, grease, spray, etc.) are present. Doing so may cause poor switch contact.

## ***This machine becomes hot.***

---

---

- Never cover the ventilation holes with cloth, tape, or anything else.
- Install in a well-ventilated location.

## ***About Tools***

---

---

- Use a cutter that is suitable for the workpiece and the cutting method.
- The tip of the tool is breakable. Handle with care, being careful not to drop it.



# ***Chapter 1***

## ***Getting Started***

---

# 1-1 Great Features

## Engraving - ENGRAVER

You can engrave nametags and other plastic plates.  
The character cutter is usually used for engraving.

## Scoring - SCORE

This scribes the surface of materials such as aluminum or brass. An optional diamond scraper that has diamond chips embedded in its tip of the cutter is used to engrave the surface of the material by scraping. This produces a lustrous engraved area and an attractive finish, especially when aluminum is used.

Tools that can be used with the EGX-30A are optionally available from your authorized Roland DG Corp. dealer or Roland DG Corp. For details, see page 46 "List of Options"

# 1-2 Part Names and Functions

## Front

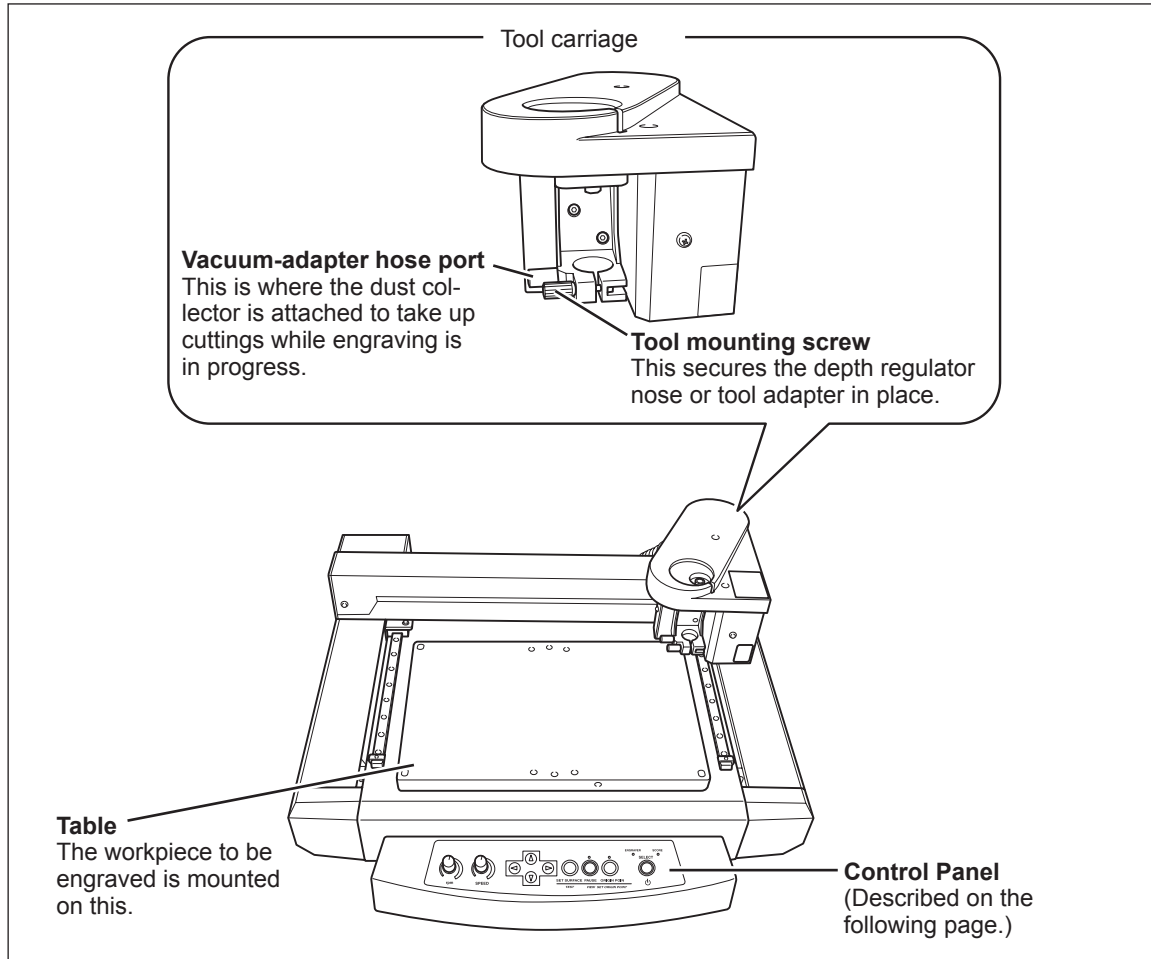

## Rear

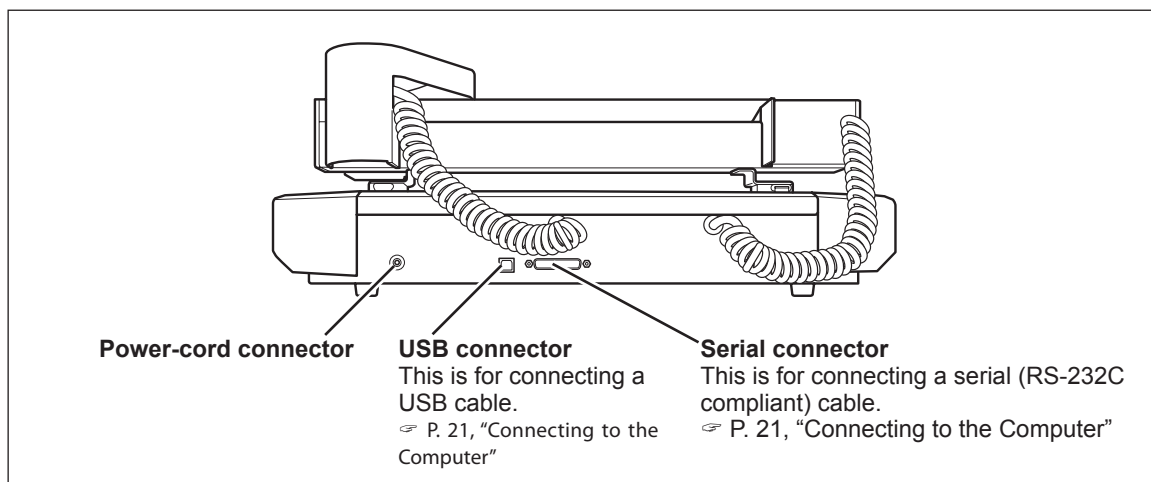

# Control Panel

**rpm knob**  
This sets the spindle speed (in rpm).

**SPEED knob**  
This sets the cutting speed.

**ARROW keys**  
These are used to move the tool carriage in the direction of the arrow. Hold down the key for faster movement.

**SELECT key**  
This selects the cutting mode. The LED for the selected mode lights up.

The functions of these keys differ depending on whether the key is pressed briefly and immediately released or held down for a certain length of time.

**SET SURFACE / TEST key**  
Pressed briefly: When the character cutter has been installed, this moves the tool up or down.  
Held down for one second or longer: Performs test cutting.

**PAUSE / VIEW key**  
Pressed briefly: Pauses operation.  
Held down for two seconds or longer: Moves the tool carriage to the rear right (the VIEW position) and pauses operation.

**ORIGIN POINT / SET ORIGIN POINT key**  
Pressed briefly: Moves the tool carriage to the origin point.  
Held down for two seconds or longer: Makes the present position of the tool carriage the origin point.





# ***Chapter 2***

## ***Installation and Set- up***

---

## 2-1 Checking the Included Items

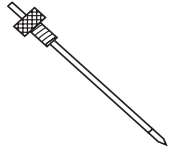
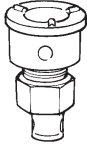
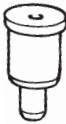
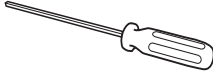
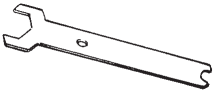
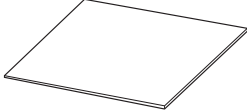
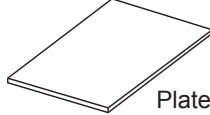
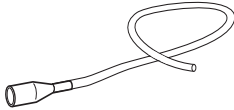
The following items are included with the machine. Make sure they are all present and accounted for.

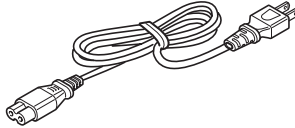
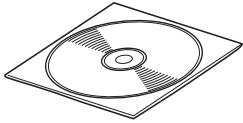
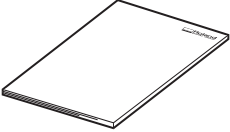
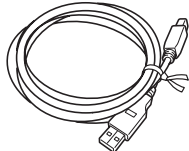
 <p>Character cutter (φ 3.175 mm)</p>	 <p>Depth regulator nose</p>	 <p>Diamond scraper adapter</p>	 <p>Hexagonal screwdriver</p>
 <p>Spanner</p>	 <p>Adhesive sheet</p>	 <p>Plate Test material</p>	 <p>Vacuum-adaptor</p>
 <p>Hexagonal wrench</p>	 <p>AC adapter</p>	 <p>Power cord</p>	 <p>Roland Software Package CD-ROM</p>
 <p>User's manual</p>	 <p>USB cable</p>		

## 2-2 Installation

### Installation Environment

Install in a quiet, stable location offering good operating conditions. An unsuitable location can cause accident, fire, faulty operation, or breakdown.

- ⚠ WARNING**     **Install in a location that is level and stable.**  
Installation in an unsuitable location may cause an accident, including a fall or tipover.
- ⚠ WARNING**     **Never install in a location exposed to open flame.**  
Cutting waste may ignite. Powdered material is extremely flammable, and even metal material may catch fire.
- ⚠ WARNING**     **Never install close to any flammable object or in a gas-filled location.**  
Combustion or explosion may be a danger.
- ⚠ WARNING**     **Never install outdoors or in any location where exposure to water or high humidity may occur.**  
Doing so may result in fire or electrical shock.
- ⚠ WARNING**     **Position so that the power plug is within immediate reach at all times.**  
This is to enable quick disconnection of the power plug in the event of an emergency. Install the machine next to an electrical outlet. Also, provide enough empty space to allow immediate access to the electrical outlet.

- Never install in a location subject to wide fluctuations in temperature or humidity.
- Never install in a location subject to shaking or vibration.
- Never install in a location where the floor is tilted, not level, or unstable.
- Never install in a dusty or dirty location, or outdoors.
- Never install in a location exposed to direct sunlight or near air-conditioning or heating equipment.
- Never install in a location exposed to considerable electrical or magnetic noise, or other forms of electromagnetic energy.
- Never install in an environment where silicone substances (oil, grease, spray, etc.) are present.

---

### Installation Space

---

Ensure that at least the following amount of space is available.

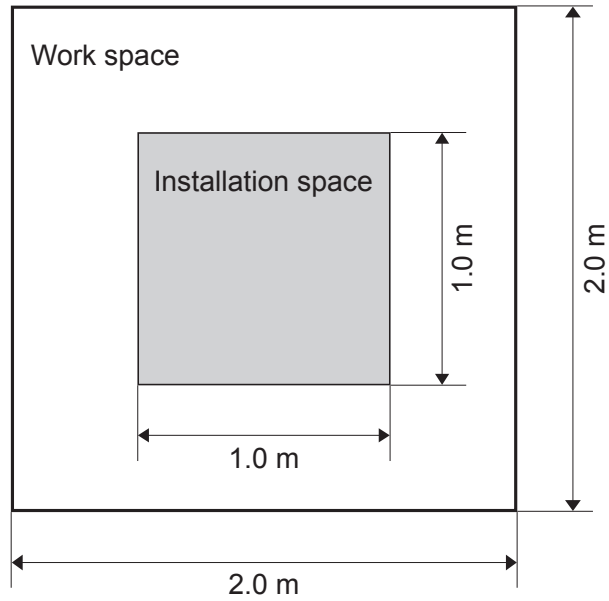

---

### About the installation location

---

The height of installation should be 0.6 m (23.7 in.) or higher above the work floor.

This machine is desktop type. Install in a location that allows easy access to areas such as the main power switch during operation.

## Unpacking

Retaining materials are attached to protect the machine from vibration during shipment. When installation is complete, remove these and store in the specified locations.

- Remove all retaining materials. Any that remain may cause faulty operation or breakdown when the power is switched on.
- The retaining materials are required when moving the machine to a different location. Store them carefully so that they do not get misplaced.

**⚠ WARNING** Carry out these operations before you connect the power cord.  
Inadvertent powerup may result in pinched hands or other injury.

### Removing the retainers

Front

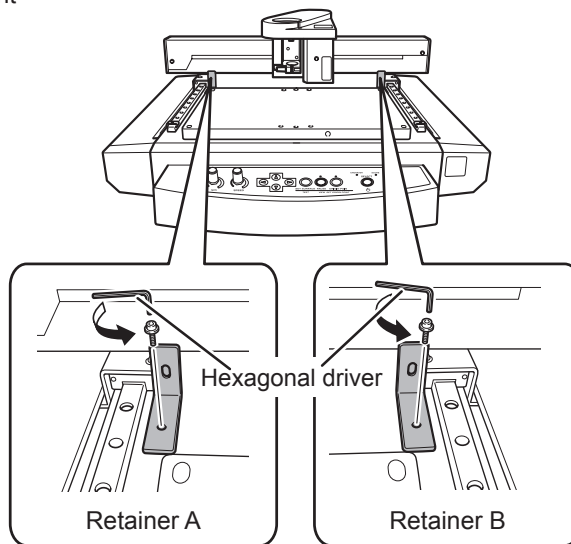

Make sure the power cord is not connected, then remove retainers A, B, and C.

Rear

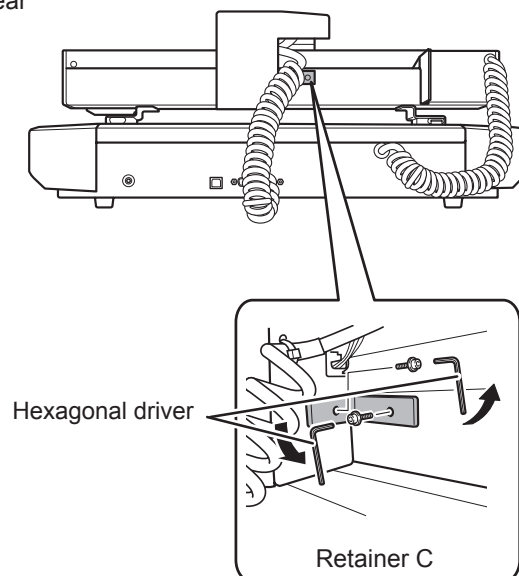

## 2-3 Cable Connections

### Connecting the Power Cord

- ⚠ WARNING** Do not use with any electrical power supply that does not meet the ratings displayed on the AC adapter. Use with any other power supply may lead to fire or electrocution.
- ⚠ WARNING** Never use any AC adapter and power cord other than the AC adapter and power cord included with the machine. Doing so may lead to fire, electrical shock, or electrocution.
- ⚠ WARNING** Handle the power cord, plug, and electrical outlet correctly and with care. Never use any article that is damaged. Using a damaged article may result in fire or electrical shock.
- ⚠ WARNING** When using an extension cord or power strip, use one that adequately satisfies the machine's ratings (for voltage, frequency, and current). Use of multiple electrical loads on a single electrical outlet or of a lengthy extension cord may cause fire.

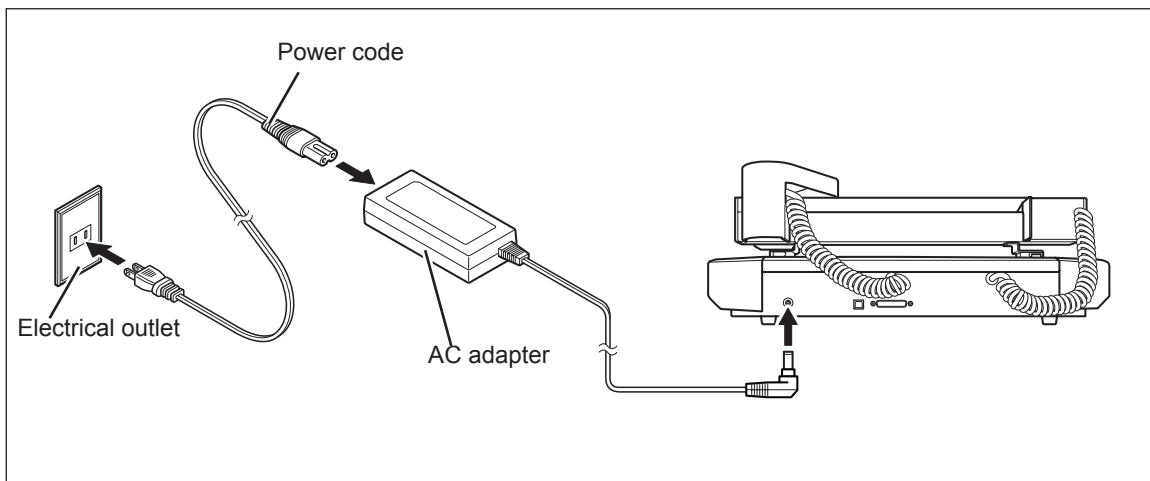

## Connecting to the Computer

### USB cable

You use a USB cable to connect the machine and the computer. At this time, however, the connection to the computer must not be made yet. You make the connection to the computer when you install the Windows-based driver.

☞ P. 23 "Installing the Windows-based Driver"

- Be sure to make the connection according to the instructions on page 23, "Installing the Windows-based Driver." Making the connection without doing so may cause driver installation to fail and make use impossible.
- Never connect two or more machines of this model to a single computer.
- For the USB cable, use the included cable.
- Never use a USB hub.

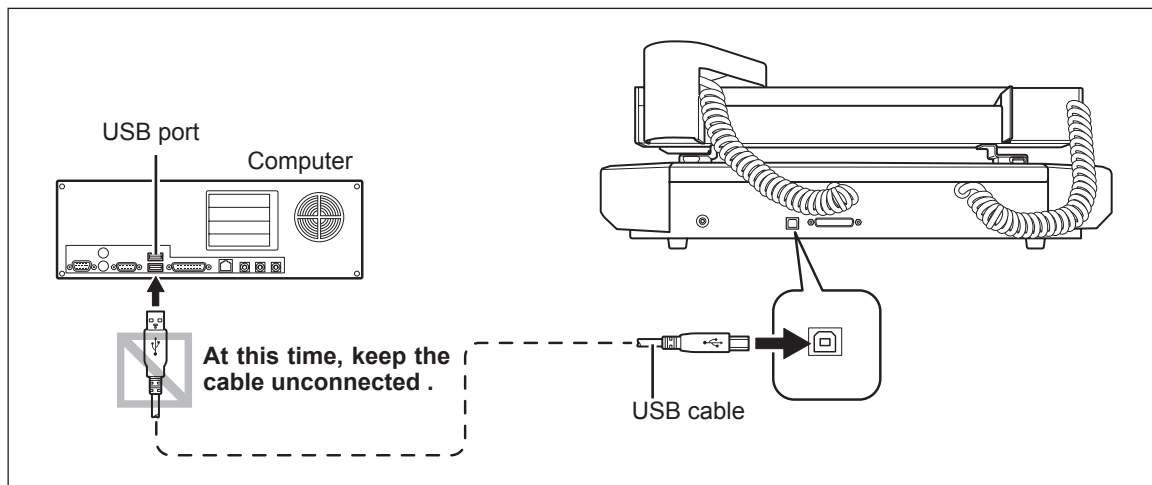

### Serial cable

Using a serial cable requires making the settings for the communication parameters with the computer. For the serial cable, use a separately available XY-RS-34 from Roland DG Corp.

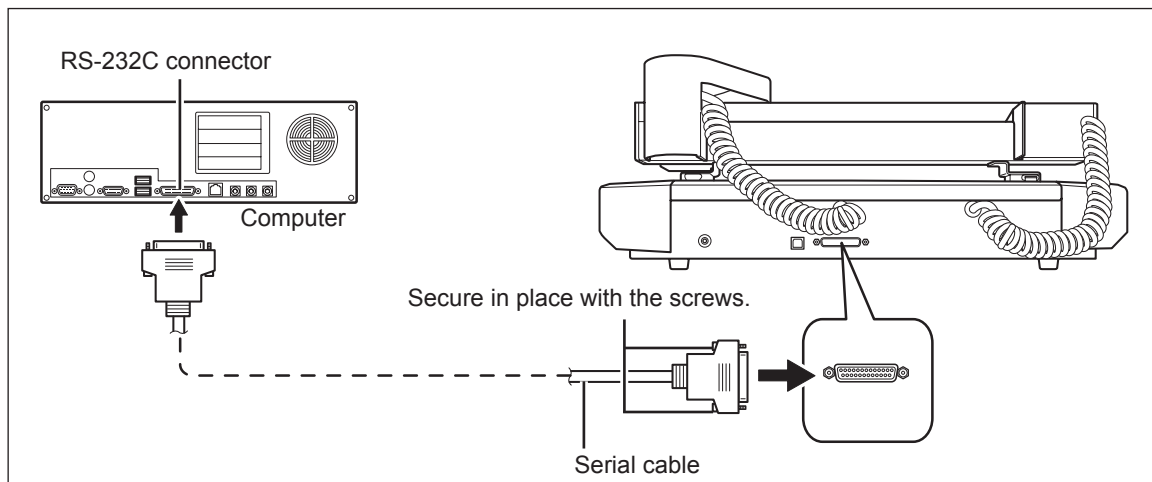

## 2-4 Installing and Setting Up the Software

### System Requirements

<b>Operating system</b>	Windows 2000 / XP / Vista ( 32bit edition )
<b>CPU</b>	The minimum required CPU for the operating system
<b>Memory</b>	The minimum amount of required RAM for the operating system
<b>Optical drive</b>	CD-ROM drive
<b>Free hard-disk space required for installation</b>	25 MB

For the latest information, see the Roland DG Corp. website (<http://www.rolanddg.com>).

### The Software You Can Install and Set Up

<b>Windows driver</b>	This is a Windows-based driver required for sending data from a computer to the machine.
<b>Dr.Engrave</b>	This program is for flat engraving of nameplates and the like. It can use any TrueType fonts registered with Windows. It also comes with its own stroke fonts. You can even import images and engrave items such as logos. There is even a feature that lets you import data from a list of names and engrave nameplates one after another.



## Installing the Windows-based Driver

### ! Notice

When connection uses a USB cable, keep the printer and the computer unconnected until you carry out this installation operation. Failure to follow the correct procedure may make installation impossible.

### Procedure

- 1 When connection uses a USB cable, before you start installation and setup, make sure the USB cable is NOT connected.
- 2 Log on to Windows as "Administrators."
- 3 Insert the Roland Software Package CD-ROM into the CD-ROM drive.  
( Windows Vista only: When the automatic playback window appears, click [Run menu. exe].)



Setup menu

Click [Install] of "Windows Driver".

An Installation and Setup Guide matched to the basic software on your computer is displayed. If you're using Windows 2000, the Installation and Setup Guide and the "Driver Setup" appear.

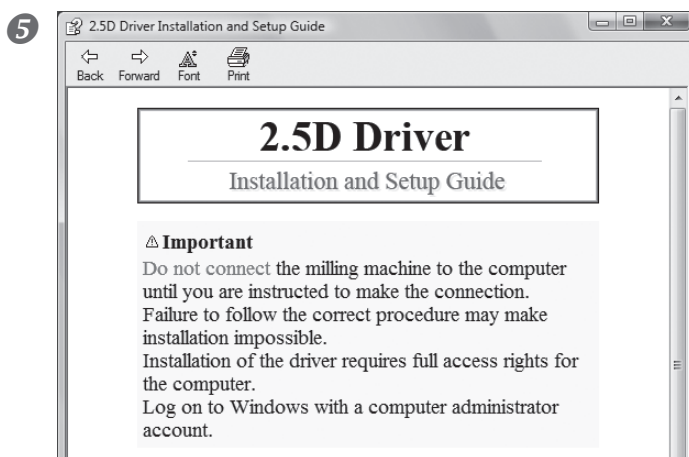

Installation and Setup Guide

Follow the instructions in the Installation and Setup Guide to finish installing.

After installation is completed, the window for the setup menu appears again. Go on to "Installing the Software ( Dr. Engrave )" on the following page.

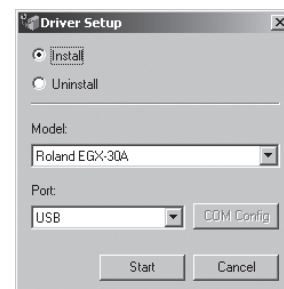

Driver Setup  
(Windows 2000)

## Installing the Software ( Dr. Engrave )

### Procedure

1 Display the setup menu of the Roland Software Package.



Click [Install] of "Dr. Engrave".

Install Menu

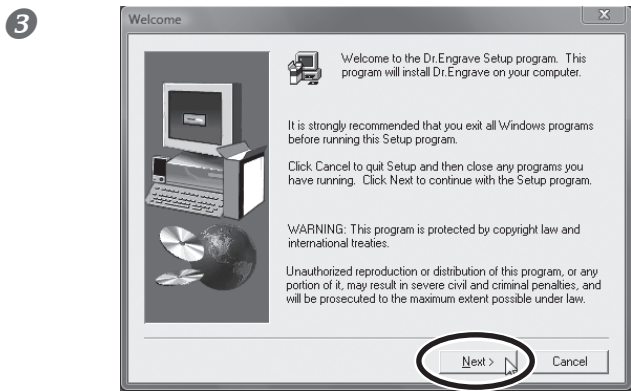

Windows 2000/XP  
The setup program starts. Follow the messages to carry out setup and finish setting up the program.

Windows Vista  
The [User Account Control] appears, click [Allow].

The setup program starts. Follow the messages to carry out setup and finish setting up the program.

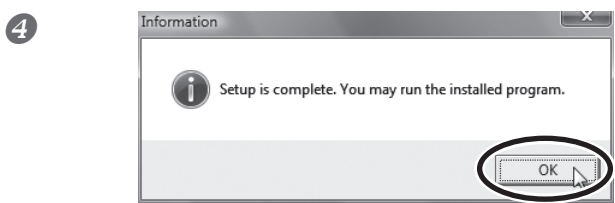

When installation finishes, the screen shown at left appears. Click [Close] or [OK].

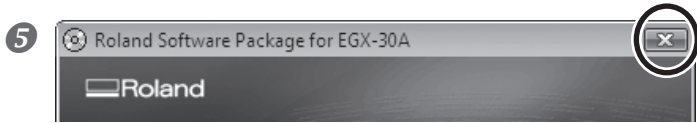

When all installation finishes, click [Close].

6 Remove the CD-ROM from the CD-ROM drive.

***Chapter 3***  
***Getting Ready for***  
***and Performing Cut-***  
***ting***

---

## 3-1 Switching the Power On and Off

### Switching On the Power

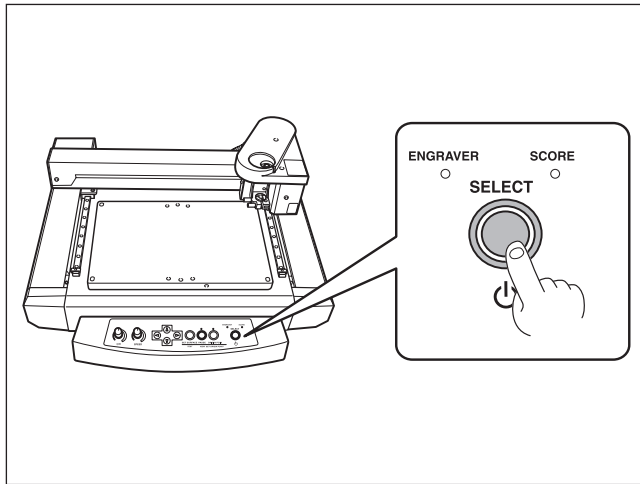

Press the SELECT key.  
The ENGRAVER ( or SCORE ) LED flashes. And the tool carriage moves to the left rear, and then to the inner right-hand side. After the movement of the tool carriage stopped, the ENGRAVER ( or SCORE ) LED lights up. This operation is called initialization.

### Switching Off the Power

Hold down the SELECT key for one second or longer.  
The ENGRAVER ( or SCORE ) LED goes dark and the power is switched off.

## 3-2 Before Starting to Cut

### Loading the Material

If the material is not secured correctly, it may not be cut as intended.

Some examples of material loading are shown below. Refer to these to use the appropriate method for the material at hand to secure it in place.

\* Material thickness -- Up to 5 mm (3/16 in.)

\* Be sure that the tool carriage is at the VIEW position ( inner right-hand side ) before loading material.

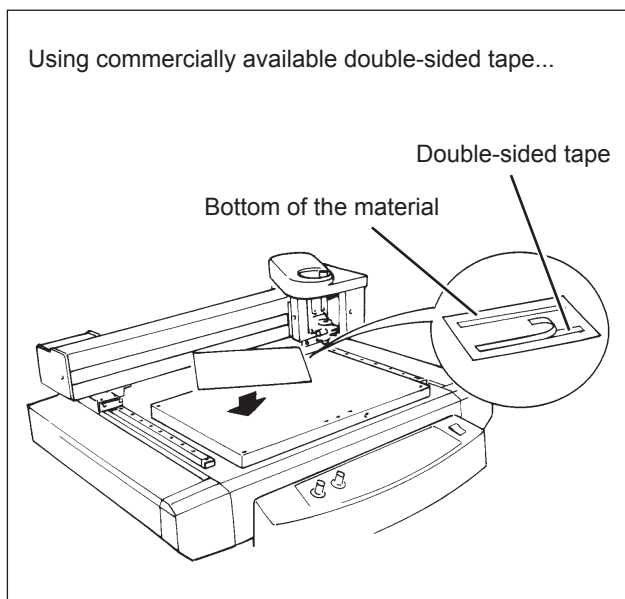
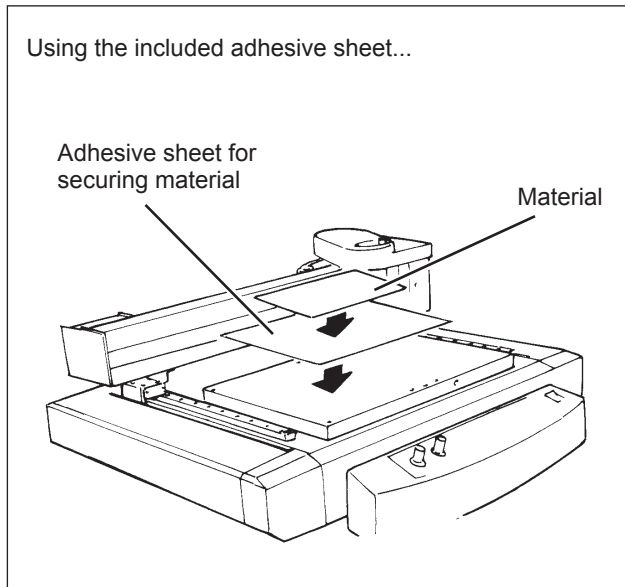

## 3-3 Installing a Tool

The steps for installing a tool are shown below. Follow these steps to install the appropriate tool for the task.

### For Engraving (Character Cutter)

\* Use SELECT key to choose "ENGRAVER" as the mode.

When installing a cutter for engraving, make sure the tip of the cutter protrudes beyond the surface of the material by an amount equal to the depth of engraving to be performed.

Move the tool carriage to a position over the material surface, then install the cutter.

#### Procedure

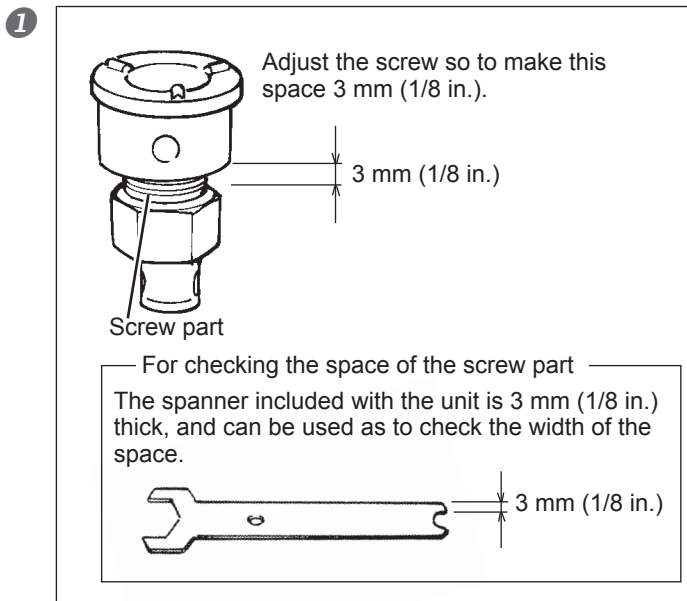

Install the depth regulator nose as shown in the figure.

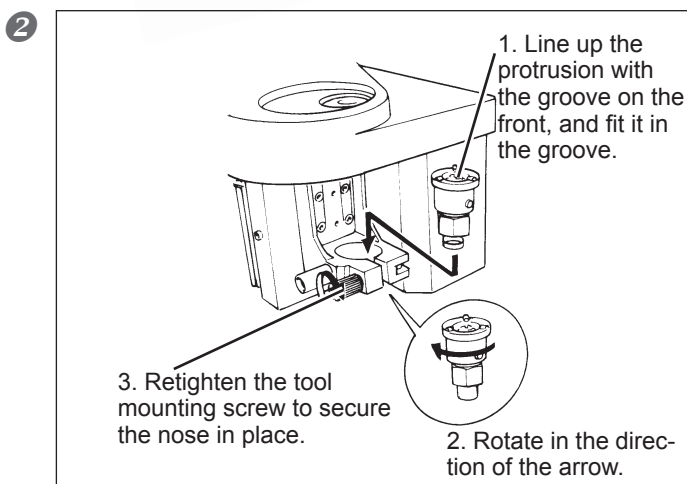

Loosen the tool mounting screw and insert the depth regulator nose in the tool carriage.

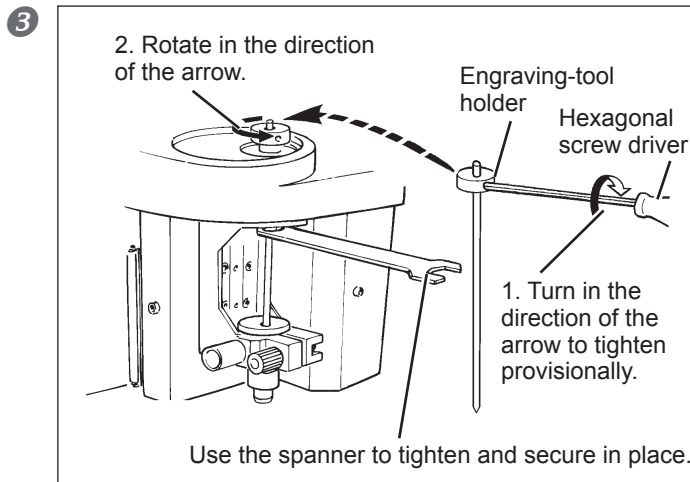

Provisionally tighten the character cutter in the engraving-tool holder, and install the engraving-tool holder on the tool carriage.

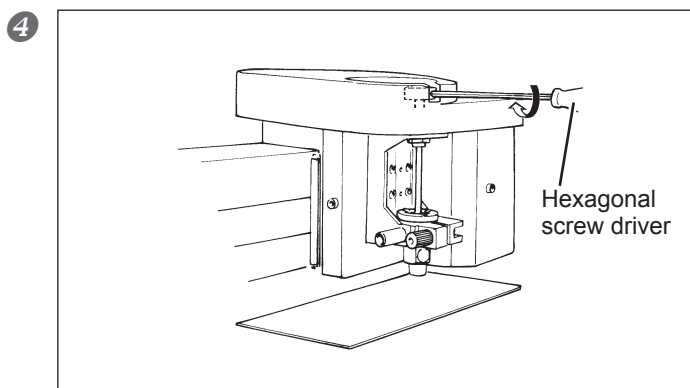

Press the SET SURFACE key to lower the tool, then loosen the screw for the engraving-tool holder.

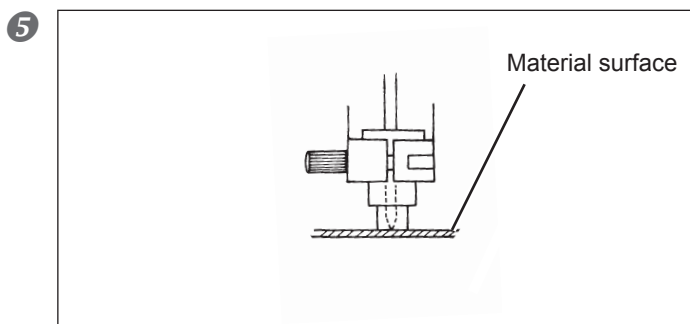

Gently lower the cutter until the tip of the cutter touches the surface of the material.

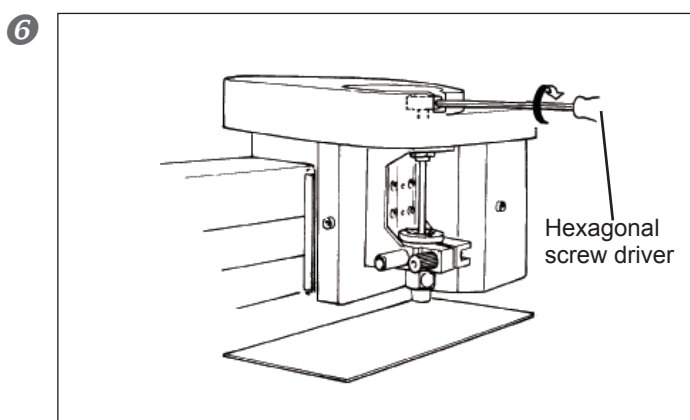

Tighten the screw securely to secure the cutter in place.

- 7 Press the SET SURFACE key to raise the cutter.  
Use the spanner to turn the depth regulator nose in the direction of the arrow to extend the blade depth to the desired engraving depth.

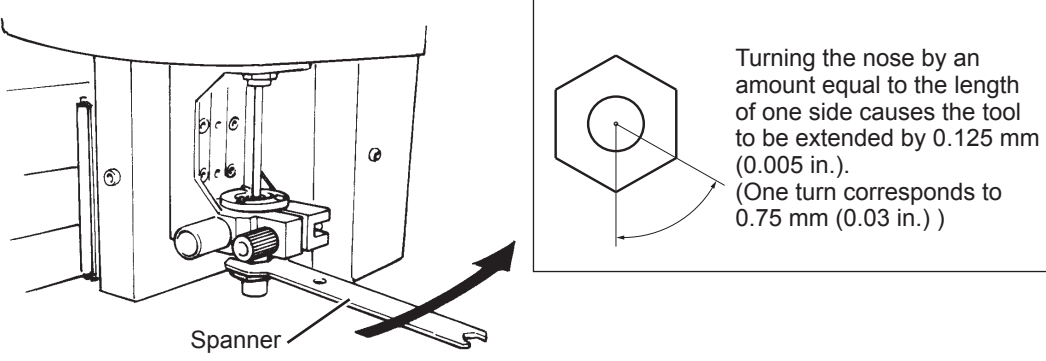

Turning the nose by an amount equal to the length of one side causes the tool to be extended by 0.125 mm (0.005 in.).  
(One turn corresponds to 0.75 mm (0.03 in.))

Spanner

When engraving an acrylic panel, the depth that can be engraved at one time is about 0.25 mm (0.01 in.). To engrave to a greater depth, repeat the same engraving several times, increasing the amount of blade extension with each pass until the desired engraving depth is reached.

**Example:** Engraving to a depth of 1 mm (0.04 in.)  
[Number of engraving passes] : 4  
[Amount of blade extension]  
1st pass: 0.25 mm (0.01 in.) -> 2nd pass: 0.5 mm (0.02 in.) ->  
3rd pass: 0.75 mm (0.03 in.) -> 4th pass: 1 mm (0.04 in.)

**Important Notes When Using the Depth Regulator Nose**

Care is needed when performing fill engraving (flat-drag cutting inside the contour lines of characters and shapes) over a wide surface area. With fill engraving that is broader than the diameter of tip of the depth regulator nose, the depth regulator nose may track the surface that has already been cut and cut the surface further

**How to Remove the Cutter for Engraving**

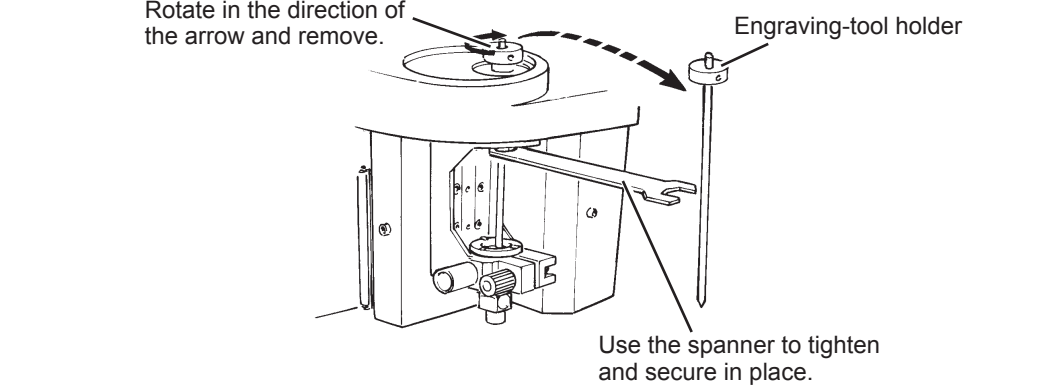

Rotate in the direction of the arrow and remove.

Engraving-tool holder

Use the spanner to tighten and secure in place.



## How to Remove the Depth Regulator Nose

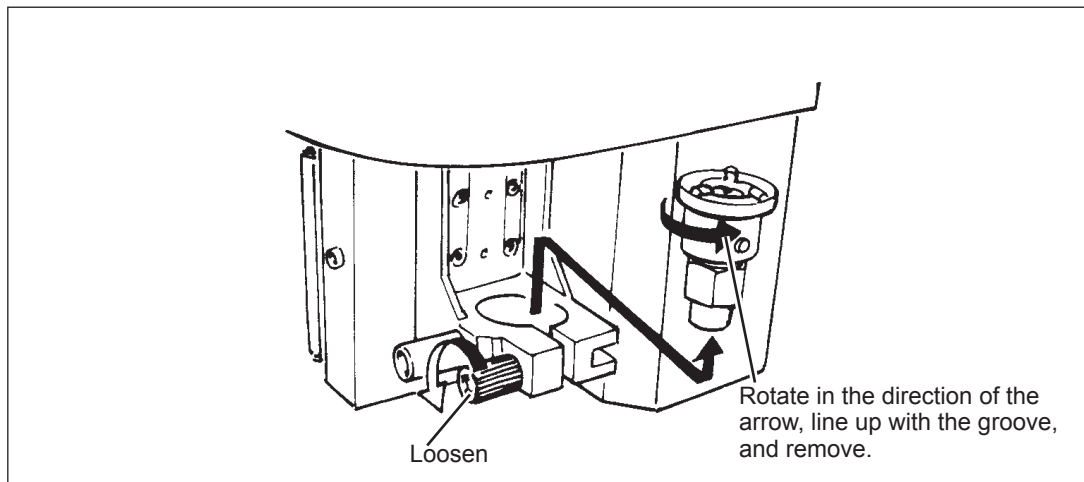

## For the Scoring (Diamond scraper)

\* Use SELECT key to choose "SCORE" as the mode.

When performing scoring, be sure to purchase the diamond scraper (optionally available).

### Procedure

1

\* If the depth regulator nose is installed, it should be removed.

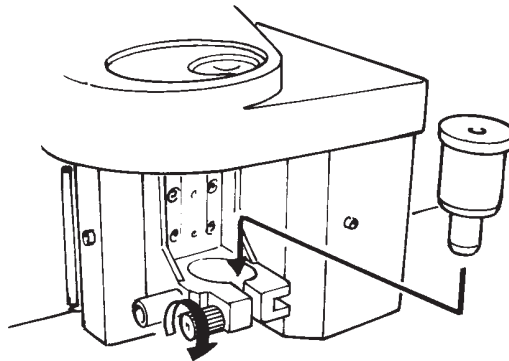

Loosen the tool mounting screw and insert the special adapter into the tool carriage.

### 3-3 Installing a Tool

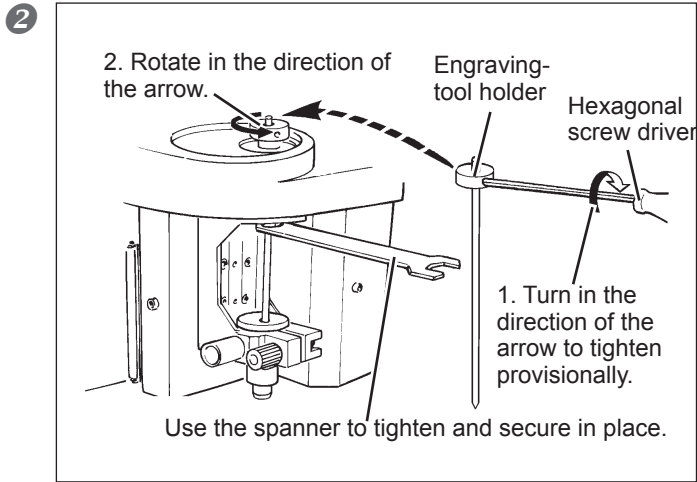

Provisionally tighten the diamond scraper in the engraving-tool holder, and insert it into the tool carriage.

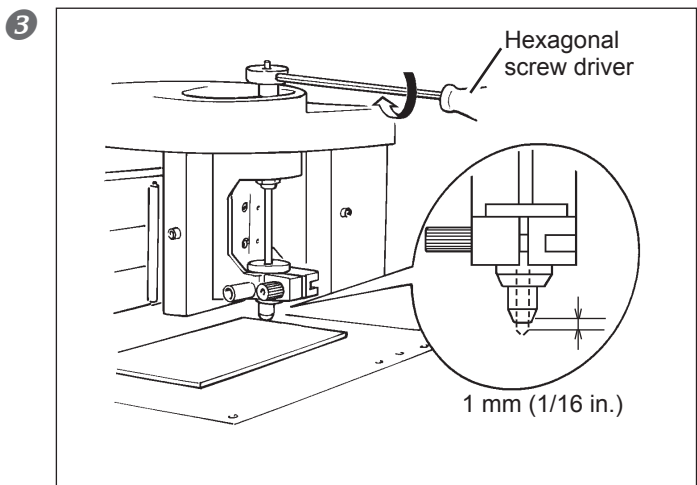

Loosen the screw for the engraving-tool holder and lower the blade of the diamond scraper until it protrudes about 1 mm (1/16 in.) from the tip of the adapter.

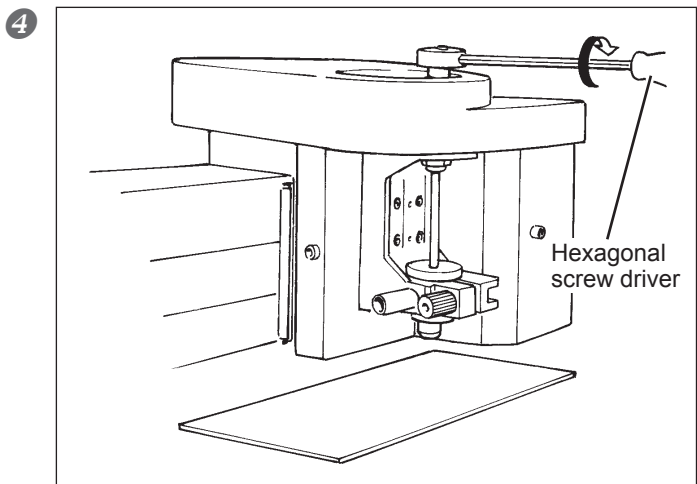

Tighten the screw securely to secure the tool in place.

## Setting the Origin Point

The origin point set with the software determines the position on the EGX-30A that is set. Usually, the origin on the EGX-30A is set to a location at the front left of the material secured in place. This section explains how to set the origin point at the front left of a piece of material.

### Procedure

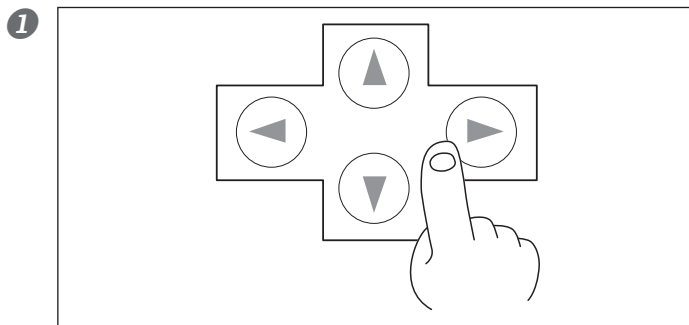

Use the arrow keys to move the tool to the front left area of the loaded material.

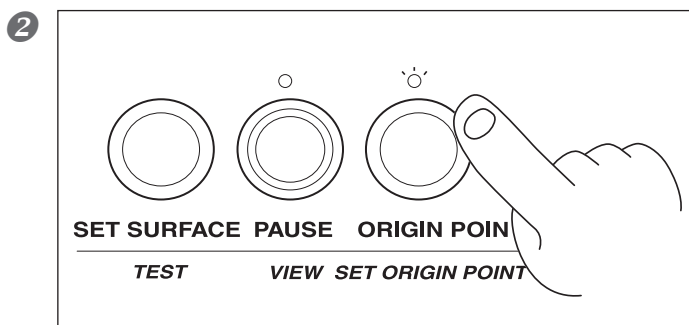

Hold down the SET ORIGIN POINT key until its LED lights up (about two seconds).

The origin point has now been set.

\*The origin point that is set here remains in memory even when the power is switched off.

## About Tools and Materials

The combinations of appropriate tools and materials for the different modes are shown below. Please refer to this to make the correct selections.

Please be aware that conditions may vary depending on factors such as the sharpness of the tool and the hardness of the material.

Mode	Tool name	Model number	Material
<b>Engraving ( ENGRAVER )</b>	Character cutter (Used with the depth regulator nose - included)	ZEC-A2025 (others)	Resin materials (nameplates, etc.)
<b>Scoring ( SCORE )</b>	Diamond scraper (Diamond scraper Adapter - included)	(ZDC-A2000)	Aluminum Brass

\*Material thickness -- Up to 5 mm (3/16 in.)

\*Engraving depth ---- Varies according to the type of material.

To achieve deep engraving on a hard material, repeatedly carry out engraving at the same location, extending the tip of the cutter slightly with each pass.

## Test Cutting

The EGX-30A can perform test cutting to check whether cutting conditions are correct. Test cutting is also recommended to determine optimal cutting conditions, such as the compatibility of the material and tool, and the cutting speed. If the results of test cutting are less than satisfactory, refer to page 33 "About Tools and Materials" and page 35 "Setting Cutting Conditions" and redo the settings. It may be a good idea to use a blank area of a piece of material or an extra scrap for test cutting.

### Procedure

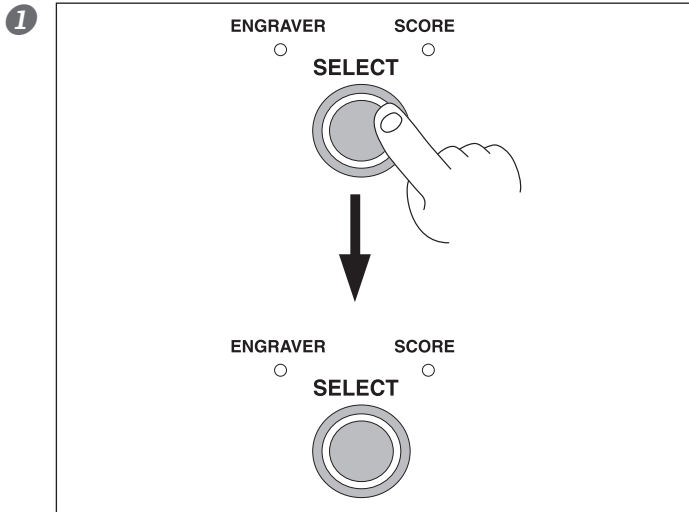

Use the SELECT key to choose the cutting mode.

The LED for the selected mode lights up.

2 Check again to make sure that the correct material and tool for the selected mode have been loaded and installed.

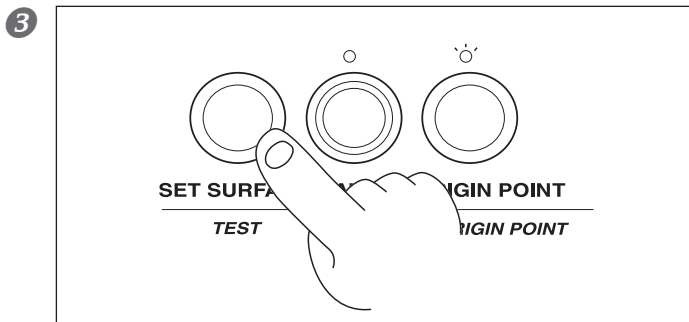

Hold down the SET SURFACE / TEST key for one second or more.

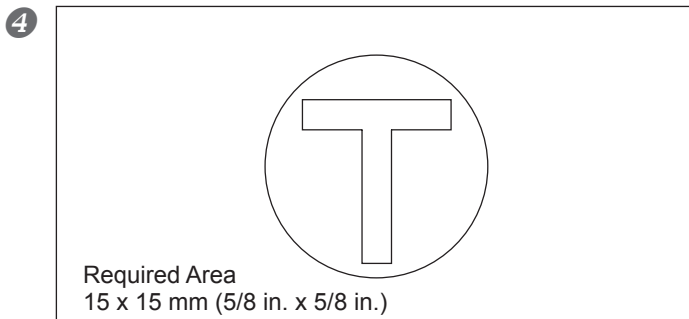

Test cutting starts.

# 3-4 Setting Cutting Conditions

## Spindle Speed

### NOTICE

- Adjust the spindle speed to match the material being engraved. Depending on the material, a spindle speed that is too fast may cause the material to melt.

Turn the rpm knob on the control panel to change the spindle speed.

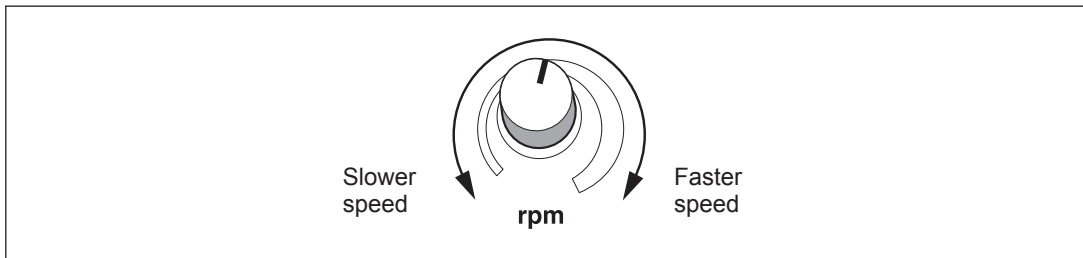

## Cutting Speed

Turn the SPEED knob on the control panel to change the cutting speed (tool-movement speed.) Although the appropriate setting may vary depending on the tool and the type of material, use the following settings as a guide.

### Engraving

Normally, you set the value at this position or a slower one.

When you're using an engraving cutter that has a narrow blade (the ZEC-A2013), set the value at this position or a slower one.

**Note:**  
In performing engraving, never set the cutting speed at any faster than that shown in the figure.  
If the cutting speed is too fast, troubles including an inaccurate output position may occur. It may even damage the cutter or result in malfunction of the machine depending on circumstances.

A diagram of a rotary knob labeled 'SPEED'. Two curved arrows point outwards from the knob, one to the left labeled 'Slower speed' and one to the right labeled 'Faster speed'. A dashed line points from the text above to a specific position on the knob.

### Scoring

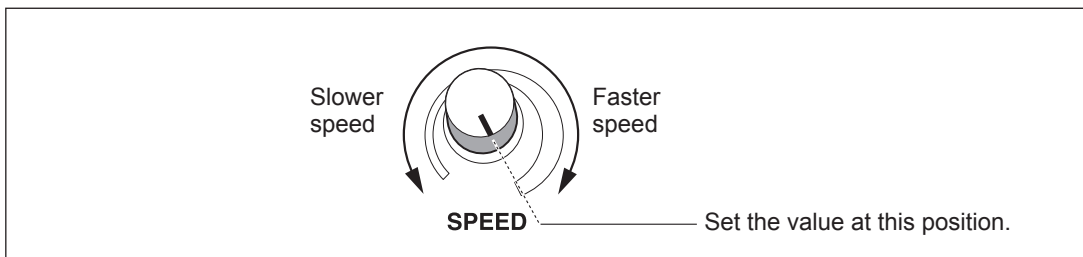

The tool-lowering speed also changes accordingly.

When the values set within the application software or the driver are sent after adjusting the cutting speed on the EGX-30A, the software and driver values are changed. Conversely, you can also change the cutting speed by rotating the knobs on the EGX-30A after starting a cutting operation using the software and driver values.

## Attaching the Vacuum-adapter for Chip Cleaning

- ⚠ WARNING**     **Exercise caution to prevent fire or dust explosion.**  
 Taking up fine cuttings using an ordinary vacuum cleaner may cause danger of fire or explosion. Check with the manufacturer of the vacuum cleaner. When the safety of use cannot be determined, never use the vacuum-adapter and a vacuum cleaner.
- ⚠ WARNING**     **Make the connection while exercising care not to touch the tip of the cutter.**  
 Contact with the blade may cause injury.
- ⚠ WARNING**     **Never touch the tool carriage immediately after cutting.**  
 Doing so may cause burns.

The vacuum-adapter included with the EGX-30A can be attached to an ordinary household vacuum cleaner to remove cutting chips during operation.

### ***Before Using the Vacuum-adapter, Be Sure to Verify the Following Points***

- Use a vacuum cleaner that allows adjustment of the suction force and is equipped with an overload protector.  
 To prevent fire or explosion, carefully check the specifications of your vacuum cleaner before use, including contacting the manufacturer if necessary.
- Be sure to use a vacuum-cleaner hose having a diameter that allows connection with the vacuum-adapter.  
 The diameter of the vacuum-adapter is 32 millimeter (1.3 in.).

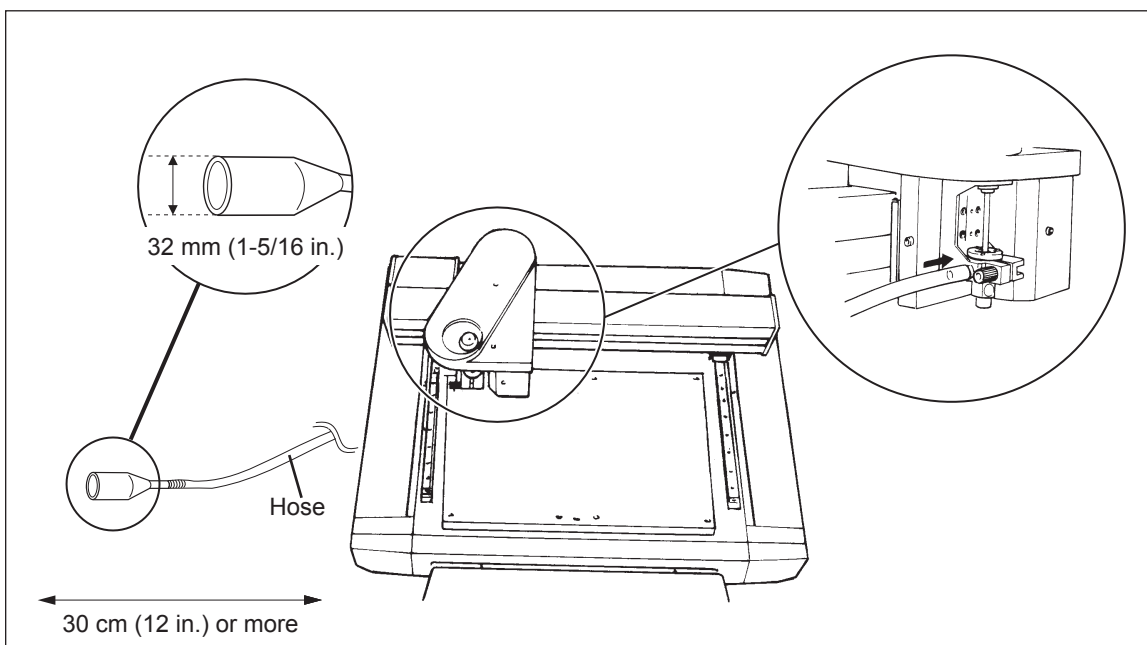

When the fitting diameters do not match or when the vacuum duct cannot be inserted into the suction opening of the vacuum cleaner, use strong commercial tape (cloth or electrical) to join the fittings.

# 3-5 Sending Cutting Data

## Sending Cutting Data

Cutting is performed when data is sent from the computer (software application). Refer to the manual for the software and drivers you are using for an explanation of how to output cutting data.

## Changes That Can Be Made While Cutting

---

### Pausing Operation

---

#### PAUSE

Pressing the PAUSE/VIEW key causes operation to pause, even when cutting is in progress. Press the PAUSE/VIEW key a second time to continue cutting.

#### ESCAPE

Holding down the PAUSE/VIEW key for one second or longer causes the tool carriage to move to the VIEW position and stop. Press the PAUSE/VIEW key a second time to continue cutting.

#### STOP

Press the PAUSE/VIEW key to pause operation. Stop sending data from the computer, then switch off the power to the EGX-30A. To restart the cutting operation from the beginning, switch the power back on, and send the data from the computer again. (The origin-point setting remains in memory even when the power is switched off.)

---

### Spindle Speed

---

Changes the rpm knob on the control panel.

---

### Cutting Speed

---

Changes the SPEED knob on the control panel.

## 3-6 Ending Cutting Operations

### Ending Cutting Operations

- ⚠ WARNING**     **Wash hands when finished.**  
Wash hands with water to remove any adhering cutting chips.
- ⚠ WARNING**     **Use a vacuum cleaner to remove cutting dust. Do not use any blower such as an airbrush.**  
Otherwise, dust spread in the air may harm your health or damage the machine.

#### Procedure

- 1** Press the PAUSE/VIEW key to move the tool carriage to a position where the tool and material can easily be removed.
- 2** Move the tool carriage to the inner-right area of the table, make sure operation is stopped, then remove the material.  
If the material is secured by an adhesive sheet or double-sided tape, peel the adhesive sheet off of the table and store it in a location free from dust.
- 3** Remove the tool and put it away.  
If the day's operations are finished, remove the cutter, depth regulator nose. Use a dry cloth to wipe away any grime, cap the cutter, and put it away.
- 4** Switch off the power to the EGX-30A.
- 5** Close the software application and switch off the computer.
- 6** If engraving was performed, vacuum up any cuttings.



# ***Chapter 4***

## ***Appendix***

---

# 4-1 Maintenance

## Cleaning

- ⚠ WARNING** **Never use a pneumatic blower.**  
This machine is not compatible with a pneumatic blower. Cutting waste may get inside the machine and cause fire or electrical shock.
- ⚠ WARNING** **Never use a solvent such as gasoline, alcohol, or thinner to perform cleaning.**  
Doing so may cause fire.
- ⚠ WARNING** **Disconnect the power cord before performing cleaning or maintenance.**  
Attempting such operations while the machine is connected to a power source may result in injury or electrical shock.
- ⚠ WARNING** **When using a vacuum cleaner to take up cutting waste, exercise caution to prevent fire or dust explosion.**  
Taking up fine cuttings using an ordinary vacuum cleaner may cause danger of fire or explosion. Check with the manufacturer of the vacuum cleaner. When the safety of use cannot be determined, clean using a brush or the like, without using the vacuum cleaner.
- ⚠ CAUTION** **Caution: high temperatures.**  
The cutting tool and spindle motor become hot. Exercise caution to avoid fire or burns.
- ⚠ CAUTION** **When performing maintenance, be sure to keep the tool detached.**  
Contact with the blade may cause injury.
- This machine is a precision device. Carry out daily care and maintenance.
  - Carefully clean away cutting waste. Operating the machine with a large amount of cutting waste present may cause malfunction.
  - Never apply silicone substances (oil, grease, spray, etc.) to the machine. Doing so may cause poor switch contact.
  - Never apply lubrication.

---

### Cleaning around the table

---

After operation, use a brush or the like to clean away any buildup of cutting waste around the table or on the machine.

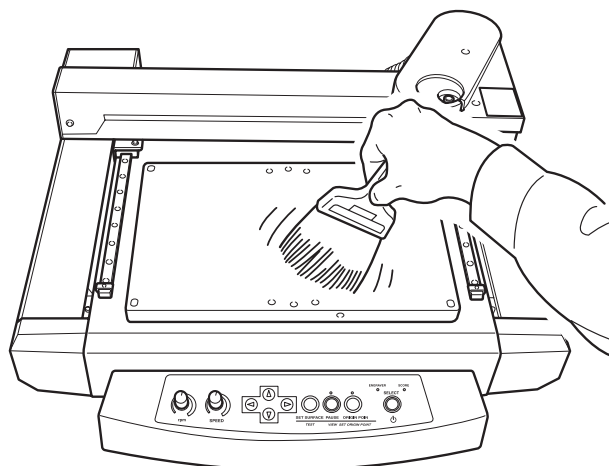

## Replacing the Bearing for the Depth Regulator Nose

When engraving is performed, cuttings may get inside the bearing, resulting in a strange noise. Because this can also degrade the quality of engraving, replacement of the bearing after every 100 hours of engraving is recommended.

### How to Remove the Bearing

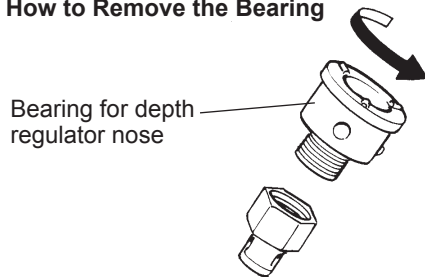

### How to Install the Bearing

Screw on the bearing for the depth regulator nose until this space is approximately 3 mm (1/8 in.).

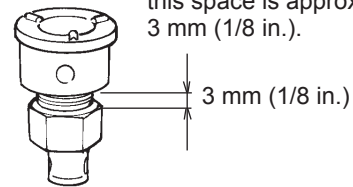

## Replacement of Spindle Belt

Please be aware that the replacement of spindle belt is charged, even when performed within the unit's warranty period.

The belt is a part that wears out.

As a guideline, the spindle belt should be replaced after every 2000 hours of use.

## 4-2 What to Do If...

### Initialization Is Not Performed or Initialization Fails.

#### Is anything caught on the tool carriage or table?

Check whether something has become caught and is impeding initialization.

### Operations Are Ignored.

#### Is the cable connected?

Connect the cable securely.

☞ P. 20, "Cable Connections"

#### Is the power switched on?

Make sure the ENGRAVER ( or SCORE ) LED is on. If it is dark, press the SELECT key to switch on the power.

#### Isn't operation paused?

When the machine is paused, cutting stops and some operations are restricted. Cancel the paused state.

☞ P. 37, "Pausing Operation"

#### Is a large amount of cutting waste present?

Clean away any cutting waste. Clean the area around the tool carriage especially carefully.

☞ P. 40, "Cleaning"

#### Is the driver installed correctly?

If the connection to the computer is not made in the sequence described, the driver may fail to be installed correctly. Check again to ensure that the connection was made using the correct procedure.

☞ P. 23, "Installing the Windows-based Driver"

#### Are the parameter settings for communication with the computer correct?

The machine cannot communicate with the computer if the parameters for communication with the computer are not set correctly. Switch the power off and back on, revise the settings such as the communication parameters for the program you're using to make sure the settings are correct, then redo the operation from the beginning.

### The Spindle Doesn't Rotate.

#### Is a large amount of cutting waste present?

Clean away any cutting waste. Clean the area around the spindle especially carefully.

☞ P. 40, "Maintenance"

### The Material Is Not Cut Correctly

#### Is the cutter broken?

Replace the cutter with a new one.

#### Are there any cutting waste adhering to the tip of the cutter?

Remove the cutter and wipe the tip with a soft cloth.

#### Is the right combination of tool and material being used?

Choose the appropriate tool for the material to be cut.

☞ P. 33, "About Tools and Materials"

#### Has the correct cutting mode been selected?

Check the SELECT setting on the operation panel.

#### Is the material secured in place so that it will not move or come loose?

Use the appropriate method for the material type to secure the material in place.

☞ P. 27, "Loading the Material"

#### Is the tool securely tightened so that it will not move or come loose?

Install the tool securely.

☞ P. 28, "Installing a Tool"

#### Have the origin been set at correct location?

Check whether the origin has been set correctly. An incorrect origin location may result in cutting at an unintended position.

☞ P. 33, "Setting the Origin Point"

### The Cutter Gets Off the Right Position or Stops During Engraving.

#### Is the cutting speed too fast?

Set the cutting speed for engraving in accordance with the instructions provided in "Cutting Speed" on page 35. Otherwise, the cutter will be misaligned or stop during the output process.

☞ P. 35, "Cutting Speed"

#### Is the extension amount of the blade too much?

If the extension amount of the blade is too much, the cutter may get stuck during cutting. In such case, adjust the amount of the blade extension. (For the acrylic sheet, the depth that can be engraved at a time is 0.25mm.)

☞ P. 28, "For Engraving (Character Cutter)"

### Installation Is Impossible

If installation quits partway through, or if the wizard does not appear when you make the connection with a USB cable, take action as follows.

#### Windows Vista

1. If the [Found New Hardware] appears, click [Cancel] to close it.
2. Click the [Start] menu, then right-click [Computer]. Click [Properties].
3. Click [Device Manager]. The [User Account Control] appears, click [Continue]. The [Device Manager] appears.
4. At the [View] menu, click [Show hidden devices].
5. In the list, find [Printers] or [Other device], then double-click it. When the model name you are using or [Unknown device] appears below the item you selected, click it to choose it.
6. Go to the [Action] menu, and click [Uninstall].
7. In "Confirm Device Uninstall" window, select [Delete the driver software for this device.], then click [OK].

8. Detach the USB cable connected to the printer, and the restart Windows.
9. Uninstall the driver. Carry out the steps from step 3 in page 43 "Uninstall the Driver Windows Vista" to uninstall the driver.
10. Install the driver again according to the procedure in page 23 "Installing the Windows-based Driver."

### Windows 2000/XP

1. If the [Found New Hardware Wizard] appears, click [Finish] to close it.

2.

#### Windows XP

Click the [Start] menu, then right-click [My Computer]. Click [Properties].

#### Windows 2000

Right-click [My Computer] on the desktop. Click [Properties].

3. Click the [Hardware] tab, then click [Device Manager]. The [Device Manager] appears.
4. At the [View] menu, click [Show hidden devices].
5. In the list, find [Printers] or [Other device], then double-click it. When the model name you are using or [Unknown device] appears below the item you selected, click it to choose it.
6. Go to the [Action] menu, and click [Uninstall].
7. In "Confirm Device Uninstall" window, click [OK].
8. Close the [Device Manager] and click [OK].
9. Detach the USB cable connected to the printer, and then restart Windows.
10. Uninstall the driver. Carry out the steps from step 3 in page 43 "Uninstall the Driver Windows 2000/XP" to uninstall the driver.
11. Install the driver again according to the procedure in page 23 "Installing the Windows-based Driver."

## Uninstalling the Driver

When uninstalling the driver, perform following operation.

### Windows Vista

1. Before you start uninstallation of the driver, unplug the USB cables from your computer.
2. Log on to Windows as "Administrators" right.
3. From the [Start] menu, click [Control Panel]. From the [Hardware and Sound] group, click [Printer]. [Printer] folder opens.
4. Click the model name's icon you are using. From the [Organize] menu, click [Delete]. The [User Account Control] appears, click [Continue].
5. A message prompting you to confirm deletion appears. Click [Yes].
6. In the [Printers] folder, right-click any location where no printer icon is present. From the [Run as administrator] menu, select [Server Properties]. The [User Account Control] appears, click [Continue].
7. Click the [Drivers] tab, then from the [Installed printer drivers] list, choose the machine to delete. Click [Remove].
8. The [Remove Driver And Package] appears, select [Remove driver and driver package]. Click [OK].
9. When the prompt message appears, click [Yes].
10. The package and driver to delete are displayed. Make sure that what is displayed is the machine you want to delete, then click [Delete].

11. The items that have been deleted are displayed. Click [OK].
  12. Click [Close] on [Remove Driver And Package] window.
  13. From the [Start] menu, choose [All Programs], then [Accessories], then [Run], and then click [Browse].
  14. Choose the name of the drive or folder where the driver is located. (\*)
  15. Select "SETUP.EXE" and click [Open], then click [OK].
  16. The [User Account Control] appears, click [Allow].
  17. The Setup program for the driver starts.
  18. Click [Uninstall] to choose it. Select the machine to delete, then click [Start].
  19. If it is necessary to restart your computer, a window prompting you to restart it appears. Click [Yes].
  20. The uninstallation finishes after the computer restarts.
- (\*) When using the CD-ROM, specify the folder as shown below (assuming your CD-ROM drive is the D drive).

D:\Drivers\25D\WINVISTA

If you're not using the CD-ROM, go to the Roland DG Corp. website (<http://www.rolanddg.com/>) and download the driver for the machine you want to delete, then specify the folder where you want to expand the downloaded file.

### Windows 2000/XP

1. Before you start uninstallation of the driver, unplug the USB cables from your computer.
2. Log on to Windows as "Administrators" right.
- 3.

#### Windows XP

From the [Start] menu, click [Control Panel]. Click [Printers and Other Hardware], then click [Printers and Faxes].

#### Windows 2000

From the [Start] menu, click [Setting]. Then click [Printers].

4. Click the model name's icon you are using. From the [File] menu, choose [Delete].
  5. A message prompting you to confirm deletion appears. Click [Yes].
  6. Go to [File] and select [Server Properties].
  7. Click the [Driver] tab, then from the [Installed printer drivers] list, choose the machine to delete.
  8. Click [Delete]. When the prompt message appears, click [Yes].
  9. From the [Start] menu, select [Run], then click [Browse].
  10. From the [File Locations] list, choose the name of the drive or folder where the driver is located. (\*)
  11. Select "SETUP.EXE" and click [Open], then click [OK].
  12. The Setup program for the driver starts.
  13. Click [Uninstall] to choose it. Select the machine to delete, then click [Start].
  14. If it is necessary to restart your computer, a window prompting you to restart it appears. Click [Yes].
  15. The uninstallation finishes after the computer restarts.
- (\*) When using the CD-ROM, specify the folder as shown below (assuming your CD-ROM drive is the D drive).
- D:\Drivers\25D\WIN2KXP
- If you're not using the CD-ROM, go to the Roland DG Corp. website (<http://www.rolanddg.com/>) and download the driver for the machine you want to delete, then specify the folder where you want to expand the downloaded file.

## 4-3 Power Rating and Serial Number Locations

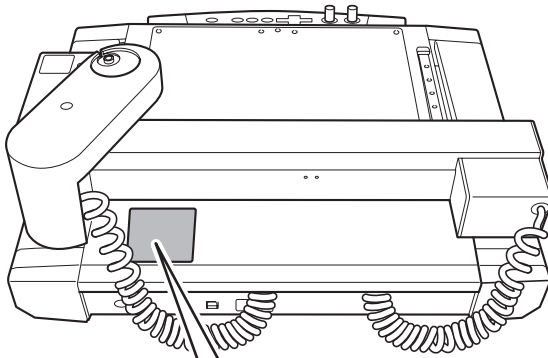

### **Serial Number**

This is required when you seek maintenance, servicing, or support. Never peel off the label or let it get dirty.

### **Power Rating**

Use an electrical outlet that meets the requirements for voltage, frequency, and amperage given here.

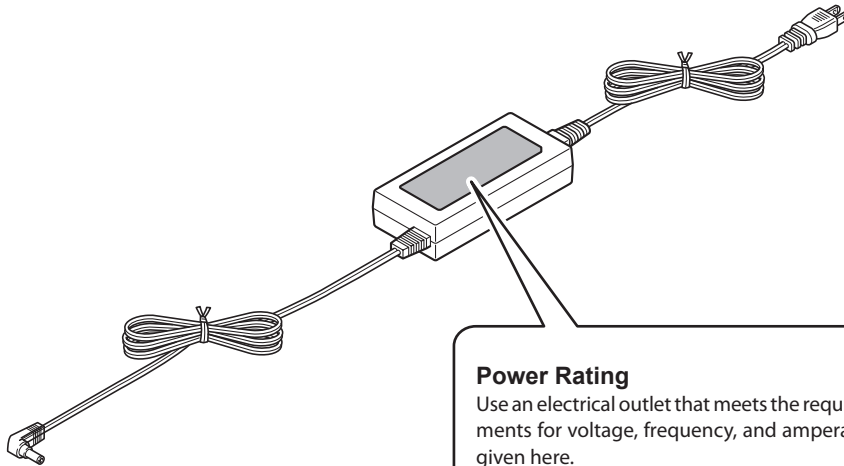

### **Power Rating**

Use an electrical outlet that meets the requirements for voltage, frequency, and amperage given here.

# 4-4 Interface Specifications

## Serial Connector

Standard	RS-232C specification
Transmission method	Asynchronous, duplex data transmission
Transmissin speed	4800, 9600, 19200, 38400
Parity check	Odd, Even, None
Data bits	7 or 8 bits
Stop bits	1 or 2 bits
Handshake	Hardware or Xon/Xoff

### Serial connector (RS-232C)

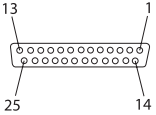
Signal number	Terminal number	Signal number	Pin connection
NC	25	13	
NC	24	12	
NC	23	11	
NC	22	10	
NC	21	9	
DTR	20	8	
NC	19	7	
NC	18	6	
NC	17	5	
NC	16	4	
NC	15	3	
NC	14	2	
	1	FG	

### XY-RS-34/14 cable connection

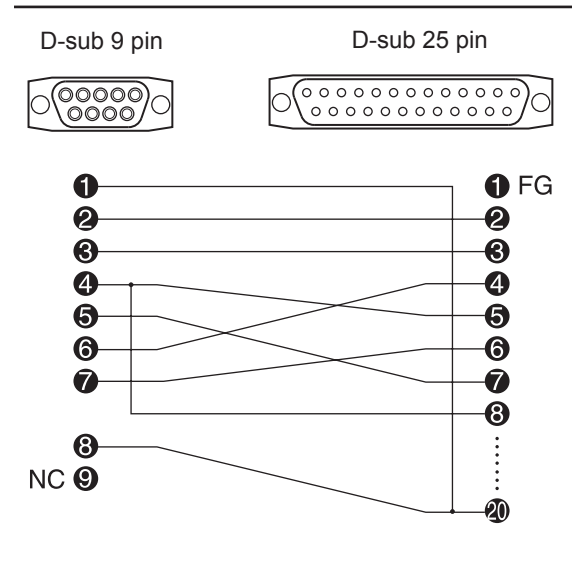

# 4-5 Appendix

## List of Options

Item	Model number	Description	
Character cutter	ZEC-A2013	High speed steel	φ 3.175 x 114(L) x 0.127(W)
	ZEC-A2025		φ 3.175 x 114(L) x 0.254(W)
	ZEC-A2051		φ 3.175 x 114(L) x 0.508(W)
	ZEC-A2076		φ 3.175 x 114(L) x 0.762(W)
Flat cutter	ZEC-A2150	High speed steel	φ 3.175 x 114(L) x 1.52(W)
	ZEC-A2190		φ 3.175 x 114(L) x 1.91(W)
	ZEC-A2230		φ 3.175 x 114(L) x 2.29(W)
	ZEC-A2320		φ 3.175 x 114(L) x 3.175(W)
Diamond scraper	ZDC-A2000	Diamond	φ 3.175 x 127(L)
Bearing for the depth regulator nose	DRN-20	3 pieces	
Adhesive sheet for securing material	AS-10	210 x 140 mm (8-1/4 x 5-1/2 in.) 10 sheets	

Unit : mm  
 φ : Cutting tool diameter  
 L : Cutting tool length  
 W : Blade width  
 D : Blade diameter



## Instruction Support Chart

The EGX-30A comes with CAMM-GL II, and supports the following commands. However, these commands are not supported in mode 1. A "CAMM-GL II Programmer's Manual" is available for separate purchase for those wishing to create their own programs for this machine. For further information, please contact the nearest Roland DG Corp. dealer or distributor.

### mode 2

Instruction	Compatibility	Instruction	Compatibility	Instruction	Compatibility
AA	○	ER	X	OE	▲
AR	○	ES	X	OF	▲
CA	X	EW	X	OH	▲
CC	X	FT	X	OI	▲
CI	○	IM	X	OO	X
CP	X	IN	○	OP	X
CS	X	IP	○	OS	X
DF	○	IW	X	OW	▲
DI	X	LB	X	PA	○
DR	X	LT	X	PD	○
DT	X	OA	▲	PR	○
EA	X	OC	▲	PT	X

Instruction	Compatibility	Instruction	Compatibility
PU	○	UC	X
RA	X	VS	○
RR	X	WD	X
SA	X	WG	X
SC	○	XT	X
SI	X	YT	X
SL	X	!VZ	○
SM	X	!NR	○
SP	●	!MC	●
SR	X	!PZ	●
SS	X	!ST	●
TL	X		

- ..... Compatible  
 ● ..... Ignored  
 ▲ ..... Compatible with serial cable / Ignored with USB cable  
 X ..... Incompatible

## Main Specifications

<b>Table</b>	305 mm (X) x 205 mm (Y) (12 in. x 8-1/16 in.)
<b>Max. Operation area</b>	305 mm (X) x 205 mm (Y) (12 in. x 8-1/16 in.)
<b>Feed rate</b>	X, Y-axis: Max. 3.0 m (118-1/16 in.)/min. (50 mm (1-15/16 in.)/sec.)
<b>Mechanical resolution</b>	0.01 mm (0.000394 in.)/step 0.00125 mm (0.0000492 in.)/step ( micro-step control )
<b>Software resolution</b>	0.01 mm (0.000394 in.)/step
<b>Distance accuracy</b>	Whichever the greater value of $\pm 0.1$ mm ( $\pm 0.00394$ in.) or $\pm 0.5\%$ of moving distance
<b>Right-angle accuracy</b>	$\pm 1$ mm (305 mm) ( $\pm 0.0394$ in. (12-1/16 in.))
<b>Spindle motor</b>	Brushless DC motor, maximum 27 W
<b>Revolution speed</b>	5,000 to 10,000 rpm.
<b>Engraving tool mounting diameter</b>	3.175 mm (1/8 in.)
<b>Number of tool up/down</b>	1 per sec.
<b>Interface</b>	USB ( compliant with Universal Serial Bus Specification Revision 1.1 ) Serial (RS-232C-compliant)
<b>LED</b>	Operation indicators 2 (PAUSE/VIEW, ORIGIN POINT/SET ORIGIN POINT) Mode indicators 2 (ENGRAVER, SCORE )
<b>Control keys</b>	▲, ▼, ►, ◄, SET SURFACE / TEST, PAUSE / VIEW, ORIGIN POINT / SET ORIGIN POINT, SELECT
<b>Power requirements</b>	Dedicated AC adapter : AC 100 to 240V $\pm 10\%$ 50/60Hz Machine : DC 24 V 0.7 A
<b>Acoustic noise level</b>	Operation mode: 70 dB (A) or less      Standby mode: 40 dB (A) or less (According to ISO 7779)
<b>External dimensions</b>	513 mm (W) x 491 mm (D) x 217 mm (H) (20-1/4 in. (W) x 19-3/8 in. (D) x 8-9/16 in. (H) )
<b>Weight</b>	13.2 kg (29.1 lb.)
<b>Operation temperature</b>	5 to 40 °C (41 to 104 °F)
<b>Operation humidity</b>	35 to 80% ( no condensation )
<b>Accessories</b>	AC adapter, Power cord, USB cable, Vacuum-adaptor, Character cutter, Depth regulator nose, Diamond scraper adapter, Hexagonal screwdriver, Spanner, Hexagonal wrench, Test material, Adhesive sheet, Roland Software package CD-ROM, User's manual

## System Requirements for USB Connection

<b>Computer</b>	Model preinstalled with Windows Vista, XP, or 2000, or upgraded computer originally preinstalled with Windows 2000 or later.
<b>USB cable</b>	Use the included USB cable.



# Please read this agreement before unpacking the media

## Software license agreement

Roland DG Corporation (hereinafter referred to as the "Company") shall grant you a non-transferable, non-exclusive right to use the Software supplied with this Agreement, on the condition that you agree to the following provisions.

If you agree to the following provisions, you should unpack the media on which the Software is recorded, or simply click the button or other indicator that you agree to the following provisions. By doing so, this Agreement shall be concluded.

If you do not agree with the following provisions, do not unpack the media. Or, you can click the button or other indicator that you do not agree to the following provisions of this Agreement. In this case, a license is not granted and you cannot use the Software.

### 1. Definition

The "Software" includes the software program and related files supplied with this Agreement and the related software programs and files distributed through the Internet and other services.

### 2. Ownership

All the ownership, copyright and other intellectual property rights of the Software, trademark, and related documents shall belong to the Company.

### 3. Terms and conditions

(1) You are authorized to use the Software on one computer.

(2) You are allowed to create a backup copy of the Software.

The right to keep the Software and the backup copy of the Software continues to belong to the Company, but the right to the media on which the backup copy of the Software is recorded does not belong to the Company.

### 4. Forbidden items

(1) This copy of the Software, or a backup copy of the Software, must not be used on multiple computers at the same time, on a network, the Internet, or on other computers through any other means of distribution.

(2) The Software shall not be reverse engineered, decompiled or reverse assembled.

(3) The rights to the Software cannot be transferred, assigned, lent, loaned or licensed to a third party in any case, regardless of whether this Agreement has been terminated or cancelled.

### 5. Termination

(1) The Company can cancel this Agreement and require you to discontinue use of the Software if you breach any provision of this Agreement or if you infringe on the ownership, copyright, or other intellectual property rights of the Company.

(2) This Agreement shall be automatically terminated when you stop using the Software.

(3) If this Agreement is terminated or cancelled, you must return your copy of the Software to the Company, or discard it as soon as practicable, at your own expense.

### 6. Guarantee

(1) The Company shall not guarantee that the quality or functionality of the Software will satisfy any purpose that you may have in mind.

(2) The Company shall not accept any responsibility for the results obtained from using the Software.

(3) The Company shall not accept any responsibility for any loss which might be caused as a result of your exercising the rights granted under this Agreement.

(4) The specifications for the Software are subject to change without prior notice.

### 7. Governing Law

This Agreement shall be governed by the laws of Japan.



100005184

R2-100520