

# *HI-FI JET*

HIGH FIDELITY 6 COLOR INKJET PRINTER

## FJ-50 \* FJ-40

### USER'S MANUAL

\* This User's Manual is intended for FJ-50 and FJ-40.

Thank you very much for purchasing the FJ-50/40.

- To ensure correct and safe usage with a full understanding of this product's performance, please be sure to read through this manual completely and store it in a safe location.
- Unauthorized copying or transferral, in whole or in part, of this manual is prohibited.
- The contents of this operation manual and the specifications of this product are subject to change without notice.
- The operation manual and the product have been prepared and tested as much as possible. If you find any misprint or error, please inform us.
- Roland DG Corp. assumes no responsibility for any direct or indirect loss or damage which may occur through use of this product, regardless of any failure to perform on the part of this product.

## For the USA

### FEDERAL COMMUNICATIONS COMMISSION RADIO FREQUENCY INTERFERENCE STATEMENT

This equipment has been tested and found to comply with the limits for a Class A digital device, pursuant to Part 15 of the FCC Rules.

These limits are designed to provide reasonable protection against harmful interference when the equipment is operated in a commercial environment.

This equipment generates, uses, and can radiate radio frequency energy and, if not installed and used in accordance with the instruction manual, may cause harmful interference to radio communications.

Operation of this equipment in a residential area is likely to cause harmful interference in which case the user will be required to correct the interference at his own expense.

Unauthorized changes or modification to this system can void the users authority to operate this equipment.

The I/O cables between this equipment and the computing device must be shielded.

## NOTICE

### Grounding Instructions

Do not modify the plug provided - if it will not fit the outlet, have the proper outlet installed by a qualified electrician.

Check with qualified electrician or service personnel if the grounding instructions are not completely understood, or if in doubt as to whether the tool is properly grounded.

Use only 3-wire extension cords that have 3-prong grounding plugs and 3-pole receptacles that accept the tool's plug.

Repair or replace damaged or worn out cord immediately.

## For Canada

### CLASS A NOTICE

This Class A digital apparatus meets all requirements of the Canadian Interference-Causing Equipment Regulations.

### CLASSE A AVIS

Cet appareil numérique de la classe A respecte toutes les exigences du Règlement sur le matériel brouilleur du Canada.



### ROLAND DG CORPORATION

1-6-4 Shinmiyakoda, Hamamatsu-shi, Shizuoka-ken, JAPAN 431-2103

MODEL NAME : See the MODEL given on the rating plate.

RELEVANT DIRECTIVE : EC MACHINERY DIRECTIVE (89/392/EEC)

EC LOW VOLTAGE DIRECTIVE (73/23/EEC)

EC ELECTROMAGNETIC COMPATIBILITY DIRECTIVE (89/336/EEC)

## WARNING

This is a Class A product. In a domestic environment this product may cause radio interference in which case the user may be required to take adequate measures.

# Table of Contents

<b>To Ensure Safe Use</b> .....	2
<b>About the Labels Affixed to the Unit</b> .....	4
<b>Pour utiliser en toute sécurité</b> .....	5
<b>À propos des étiquettes collées sur l'appareil</b> .....	8
<b>1 Introduction</b> .....	9
1-1 Checking Accessories .....	9
1-2 Part Names .....	10
Operation Panel .....	10
Front View .....	11
Rear View .....	11
Inside the Front Cover .....	11
1-3 Setting Up and Connection .....	12
Setting Up .....	12
Connection .....	13
<b>2 Basic Operation</b> .....	15
2-1 Attach the Drain Bottle .....	15
2-2 Installing Ink Cartridges .....	16
2-3 Powerup .....	18
2-4 Loading the Material .....	19
Loading Roll Material .....	19
Loading Sheet Material .....	21
2-5 Printing Test .....	22
2-6 Printing .....	23
Downloading Printing Data .....	23
Setting the Printing Mode .....	25
Printing at the Desired Location .....	26
Making Corrections for Printing .....	29
2-7 Ending Printing Operations .....	31
Remove the Material .....	31
Separating the Printed Portion .....	31
2-8 When Not in Use... .....	32
Power Off in Daily Operation .....	33
When Not in Use for a Prolonged Period ... .....	33
2-9 Other Functions .....	34
Performing Overprinting .....	34
Setting the Page Margins .....	35
<b>3 Maintenance</b> .....	36
3-1 Replacing the Ink Cartridges .....	36
3-2 Remaining Ink .....	38
3-3 Cleaning the Printing Heads .....	38
3-4 Changing the Type of Ink .....	40
3-5 How to Replace the Separating Knife .....	41
3-6 Cleaning .....	42
3-7 When Moving the Unit... .....	43
<b>4 User's Reference</b> .....	45
4-1 Materials .....	45
Conditions for Usable Materials .....	45
Acceptable material widths .....	45
4-2 Adjusting the Height of the Printing Head .....	45
4-3 Printing Area .....	46
4-4 Display Menus Flowchart .....	47
4-5 Description of Keys and Display Menus .....	50
Description of Keys .....	50
Description of Menus .....	52
4-6 What to Do If... .....	55
What to Do If... .....	55
Messages .....	60
Error Messages .....	61
4-7 Specifications .....	62

Windows® is a registered trademark or trademark of Microsoft® Corporation in the United States and/or other countries.



IBM is a registered trademark of International Business Machines Corporation.

Macintosh is a registered trademark or trademark of Apple Computer, Inc. in the USA and other countries.



COLORCHOICE® is a registered in the U.S. Patent Office.

# To Ensure Safe Use

## About ⚠ WARNING and ⚠ CAUTION Notices

 <b>WARNING</b>	Used for instructions intended to alert the user to the risk of death or severe injury should the unit be used improperly.
 <b>CAUTION</b>	Used for instructions intended to alert the user to the risk of injury or material damage should the unit be used improperly. * Material damage refers to damage or other adverse effects caused with respect to the home and all its furnishings, as well to domestic animals or pets.

## About the Symbols

	The ⚠ symbol alerts the user to important instructions or warnings. The specific meaning of the symbol is determined by the design contained within the triangle. The symbol at left means "danger of electrocution."
	The ⓧ symbol alerts the user to items that must never be carried out (are forbidden). The specific thing that must not be done is indicated by the design contained within the circle. The symbol at left means the unit must never be disassembled.
	The ● symbol alerts the user to things that must be carried out. The specific thing that must be done is indicated by the design contained within the circle. The symbol at left means the power-cord plug must be unplugged from the outlet.

## ⚠ WARNING



**Do not disassemble, repair, or modify.**

Doing so may lead to fire or abnormal operation resulting in injury.



**Use only with a power supply of the same rating as indicated on the unit.**

Use with any other power supply may lead to fire or electrocution.



**Ground the unit with the ground wire.**

Failure to do so may result in risk of electrical shock in the even of a mechanical problem.



**Do not use while in an abnormal state (i.e., emitting smoke, burning odor, unusual noise, or the like).**

Doing so may result in fire or electrical shock.  
 Immediately switch off first the sub power, then the main power, unplug the power cord from the electrical outlet, and contact your authorized Roland DG Corp. dealer or service center.

## ⚠ CAUTION



**Do not use with a damaged power cord or plug, or with a loose electrical outlet.**

Use with any other power supply may lead to fire or electrocution.

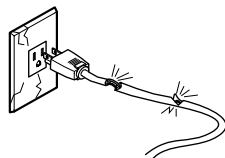

**When not in use for extended periods, unplug the power cord from the electrical outlet.**

Failure to do so may result in danger of shock, electrocution, or fire due to deterioration of the electrical insulation.

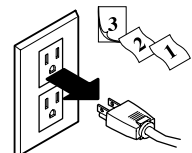

## CAUTION



**Do not injure or modify the electrical power cord, nor subject it to excessive bends, twists, pulls, binding, or pinching, nor place any object of weight on it.**

Doing so may damage the electrical power cord, leading to electrocution or fire.

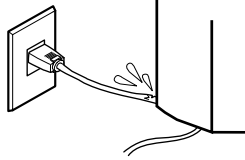

**When unplugging the electrical power cord from the power outlet, grasp the plug, not the cord.**

Unplugging by pulling the cord may damage it, leading to fire or electrocution.

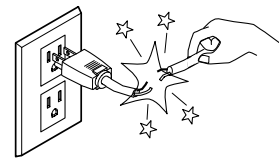

**Do not attempt to unplug the power cord with wet hands.**

Doing so may result in electrical shock.

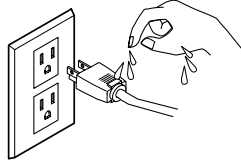

**Do not allow liquids, metal objects or flammables inside the machine.**

Such materials can cause fire.

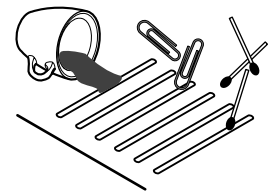

**Unpacking, installation, and moving must be carried out by two or more persons.**

Failure to do so may result in falling of the unit, leading to injury.

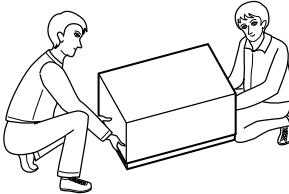

**Use the joining screws to secure the unit to the stand.**

Failure to do so may result in falling of the unit, leading to injury.

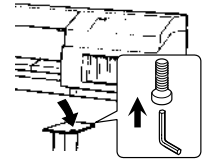

**Install in a level and stable location.**

Otherwise the unit may tip over and cause injury.

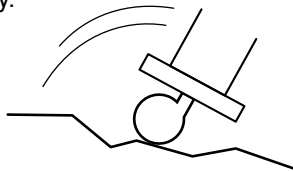

**Use care to avoid pinching the fingers when placing the unit on the stand.**

Doing so may result in injury.

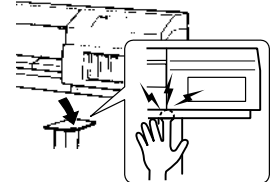

**Roll material must be placed at a predetermined shaft position.**

Failure to do so may result in falling of the roll, leading to injury.

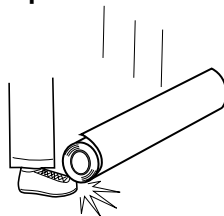

**Release the caster locks for the stand before attempting to move.**

Otherwise the unit may tip over and cause injury.

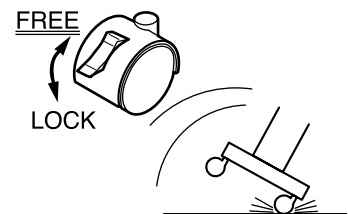

**Do not touch the tip of the separating knife with your fingers.**

Doing so may result in injury.



**Make sure the power to the unit is off before attempting to replace the separating knife.**

Doing so may result in injury.

## ⚠ CAUTION



**Do not place hands within the space to the front of the unit while in operation.**

Doing so may result in injury.

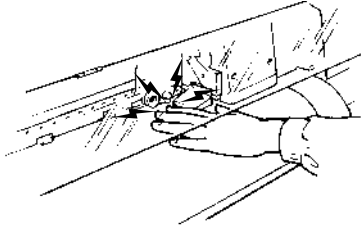

**If ink contacts the eyes, flush immediately with water.**



**Store ink cartridges out of the reach of children.**

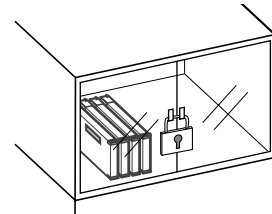

## About the Labels Affixed to the Unit

These labels are affixed to the body of this product. The following figure describes the location and content of these messages.

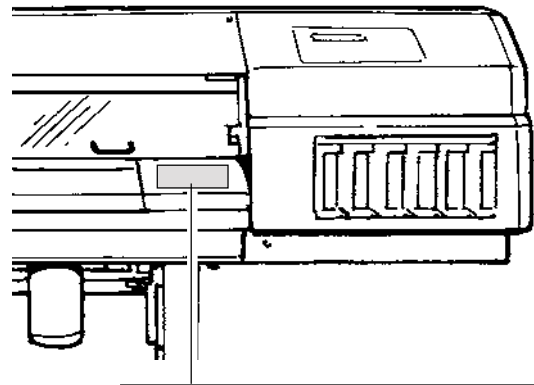
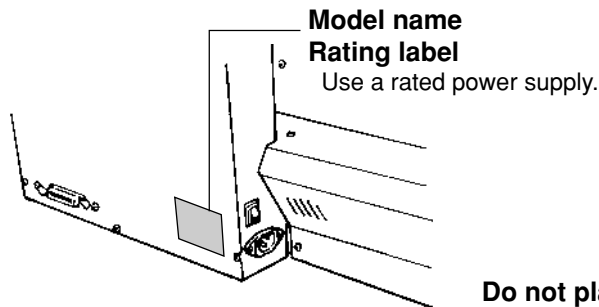

**Do not place hands within the space to the front of the unit while in operation.**

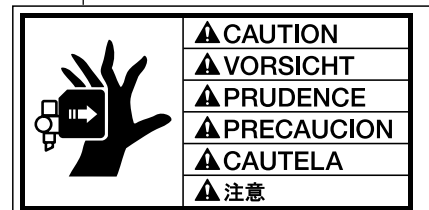

### Ink cartridge

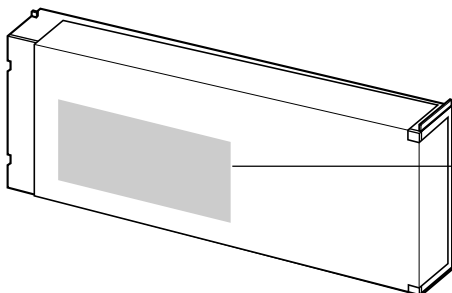

**Do not dismantle the cartridge.**  
**Keep out of reach of children.**  
**Do not store the cartridge in high or freezing temperatures.**

In addition to the ⚠ **WARNING** and ⚠ **CAUTION** symbols, the symbols shown below are also used.



**NOTICE** : Indicates information to prevent machine breakdown or malfunction and ensure correct use.









: Indicates a handy tip or advice regarding use.

# Pour utiliser en toute sécurité

## Avis sur les avertissements

 <b>ATTENTION</b>	Utilisé pour avertir l'utilisateur d'un risque de décès ou de blessure grave en cas de mauvaise utilisation de l'appareil.
 <b>PRUDENCE</b>	Utilisé pour avertir l'utilisateur d'un risque de blessure ou de dommage matériel en cas de mauvaise utilisation de l'appareil. * Par dommage matériel, il est entendu dommage ou tout autre effet indésirable sur la maison, tous les meubles et même les animaux domestiques.

## À propos des symboles

	Le symbole  attire l'attention de l'utilisateur sur les instructions importantes ou les avertissements. Le sens précis du symbole est déterminé par le dessin à l'intérieur du triangle. Le symbole à gauche signifie "danger d'électrocution".
	Le symbole  avertit l'utilisateur de ce qu'il ne doit pas faire, ce qui est interdit. La chose spécifique à ne pas faire est indiquée par le dessin à l'intérieur du cercle. Le symbole à gauche signifie que l'appareil ne doit jamais être démonté.
	Le symbole  prévient l'utilisateur sur ce qu'il doit faire. La chose spécifique à faire est indiquée par le dessin à l'intérieur du cercle. Le symbole à gauche signifie que le fil électrique doit être débranché de la prise.

## **ATTENTION**



### **Ne pas démonter, réparer ou modifier.**

Le non-respect de cette consigne pourrait causer un incendie ou provoquer des opérations anormales entraînant des blessures.



### **Utiliser seulement avec une alimentation de mêmes caractéristiques électriques que celles indiquées sur l'appareil.**

Une négligence à ce niveau pourrait provoquer un incendie ou une électrocution.



### **Mettre l'appareil à la masse avec une prise de terre.**

Le non-respect de cette consigne pourrait entraîner des décharges électriques en cas de problème mécanique.



### **Ne pas utiliser si l'appareil est dans un état anormal (c'est-à-dire s'il y a émission de fumée, odeur de brûlé, bruit inhabituel etc.).**

Le non-respect de cette consigne pourrait provoquer un incendie ou des décharges électriques.

Couper immédiatement l'alimentation secondaire et ensuite l'alimentation principale. Débranchez le fil électrique et contacter votre revendeur ou votre centre de service de la société Roland DG autorisé.

## PRUDENCE



**Ne pas utiliser avec une fiche ou un fil électrique endommagé ou avec une prise mal fixée.**

Une négligence à ce niveau pourrait provoquer un incendie ou une électrocution.

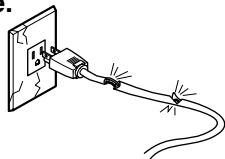

**Débrancher le fil lorsque l'appareil reste inutilisé pendant une longue période.**

Une négligence à ce niveau pourrait provoquer des décharges électriques, une électrocution ou un incendie dû à une détérioration de l'isolation électrique.

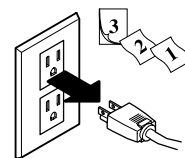

**Ne pas endommager ou modifier le fil électrique. Ne pas le plier, le tordre, l'étirer, l'attacher ou le serrer de façon excessive. Ne pas mettre d'objet ou de poids dessus.**

Une négligence à ce niveau pourrait endommager le fil électrique ce qui risquerait de provoquer une électrocution ou un incendie.

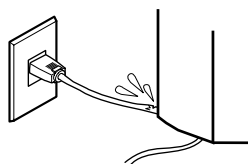

**Saisir la fiche et non le fil électrique lorsque vous débranchez.**

Débrancher en tirant sur le fil pourrait l'endommager et risquer de provoquer un incendie ou une électrocution.

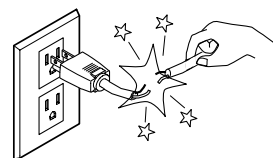

**Ne pas essayer de débrancher le fil avec des mains mouillées.**

Une négligence à ce niveau pourrait provoquer des décharges électriques.

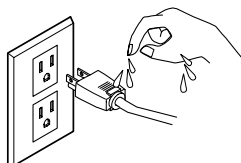

**Ne pas introduire de liquide, d'objet métallique ou inflammable dans l'appareil.**

Ce genre de matériel peut provoquer un incendie.

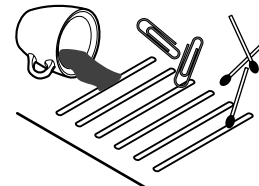

**Le déballage, l'installation et le déplacement de l'appareil doivent être effectués par deux personnes ou plus.**

Le non-respect de cette consigne pourrait causer des défauts dans l'appareil entraînant des blessures.

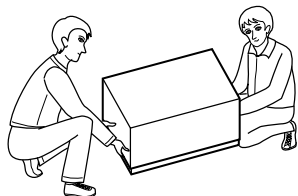

**Utiliser les vis fournies pour bien fixer l'appareil sur le support.**

Le non-respect de cette consigne pourrait causer des défauts dans l'appareil entraînant des blessures.

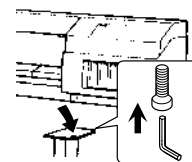

**Installer dans un endroit stable et de niveau.**

Si non l'appareil pourrait se renverser et provoquer des blessures.

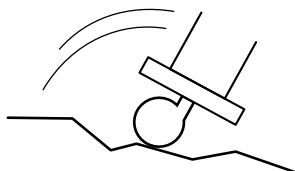

**Manipuler avec précaution pour éviter de se coincer les doigts lors de l'installation de l'appareil sur le support.**

Une négligence à ce niveau pourrait provoquer des blessures.

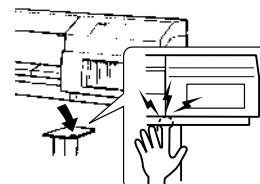



## PRUDENCE



**Le rouleau doit être placé quand la barre est en position adéquate.**

Une négligence à ce niveau pourrait provoquer la chute du rouleau et causer des blessures.

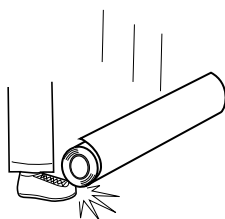

**Débloquer le mécanisme d'arrêt des roulettes du support avant de le déplacer.**

Sinon l'appareil pourrait se renverser et provoquer des blessures.

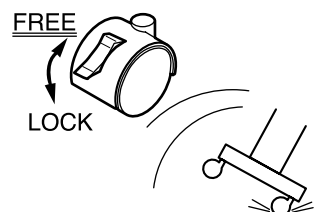

**Ne pas toucher le bout de la lame séparatrice avec les doigts.**

Une négligence à ce niveau pourrait provoquer des blessures.



**S'assurer que l'appareil est hors tension avant d'essayer de remplacer la lame séparatrice.**

Une négligence à ce niveau pourrait provoquer des blessures.



**Ne pas mettre les mains dans l'espace du devant quand l'appareil est en marche.**

Une négligence à ce niveau pourrait provoquer des blessures.

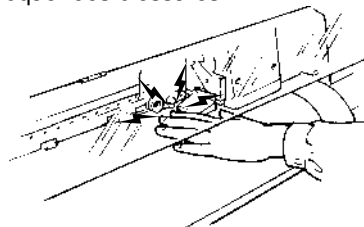

**Si de l'encre entre en contact avec les yeux, rincer immédiatement à l'eau.**



**Ranger les cartouches d'encre hors de portée des enfants.**

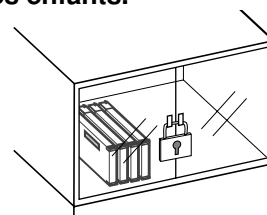

# À propos des étiquettes collées sur l'appareil

Ces étiquettes sont collées à l'extérieur de l'appareil.  
Les dessins suivants indiquent l'endroit et le contenu des messages.

**Nom du modèle**  
**Étiquette des caractéristiques électriques**  
Utiliser l'alimentation appropriée

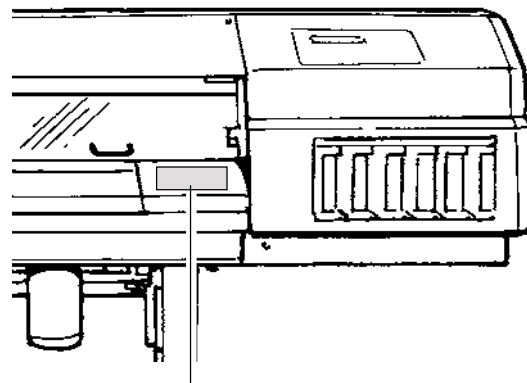
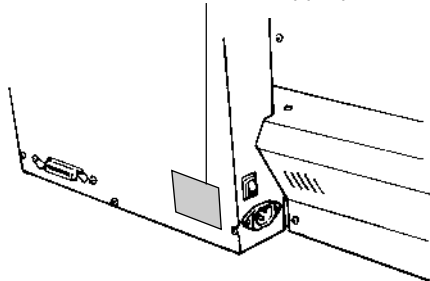

**Ne pas mettre les mains dans l'espace devant l'élément quand celui-ci est en marche.**

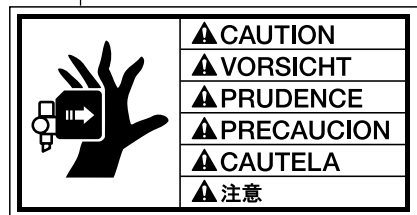

## la cartouche d'encre

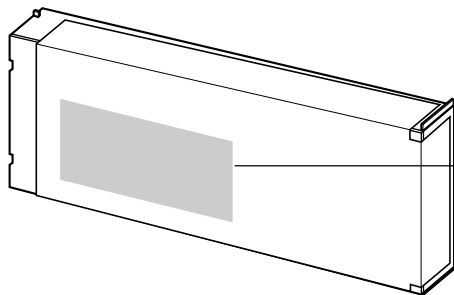

**Ne pas démonter la cartouche.**  
**Conserver hors de la portée des enfants.**  
**Ne pas emmagasiner à des températures hautes ou basses.**

---

# 1 Introduction

---

\* In this manual, sections that explain common points for the FJ-50/40 use only illustrations of the FJ-50. Some details of the FJ-40 differ from the figure.

## 1-1 Checking Accessories

Check the following to make sure that you received all the items that were shipped along with the unit.

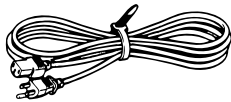

Power cord: 1



Drain bottle: 1



Drain-bottle cap: 1



Screws: 2

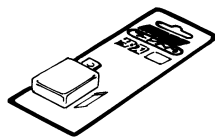

Replacement blade for separating knife: 1

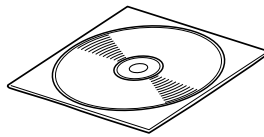

Roland COLORCHOICE®  
CD-ROM: 1

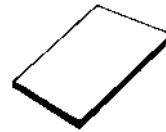

User's manual: 1

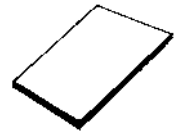

Roland COLORCHOICE®  
installation guide: 1

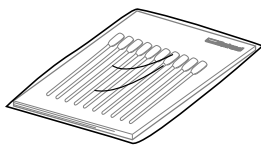

Cleaning kit: 1

# 1-2 Part Names

**NOTICE** If you will leave the printing head being uncapped for a long time (for example, open the front cover while printing is made on the middle of platen), printing heads may get clogging and, in some case it results unrecoverable damage to the printing head.

Do not touch the Y rail or the inner side of the right cover. Touching the area shown may cause the fingers to be soiled by grease or ink, and may result in diminished image quality.

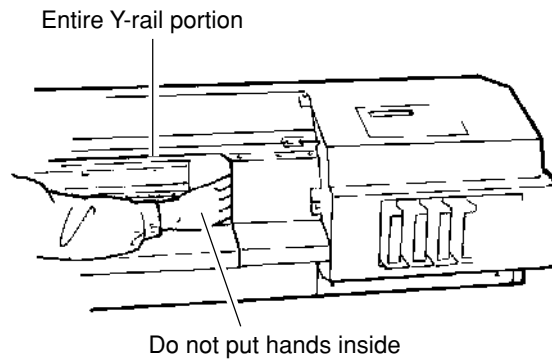

## Operation Panel

For more information about the keys, take a look at "4-5 Description of Keys and Display Menus".

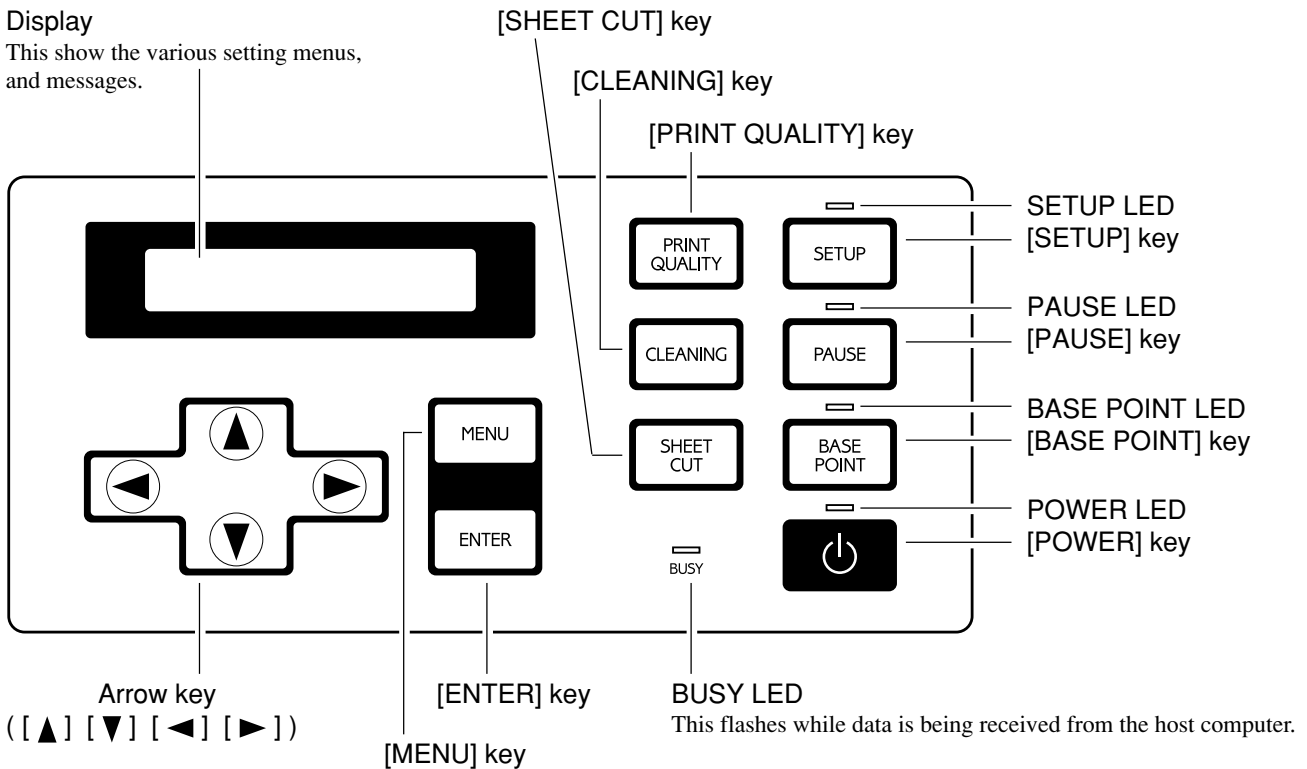

## Front View

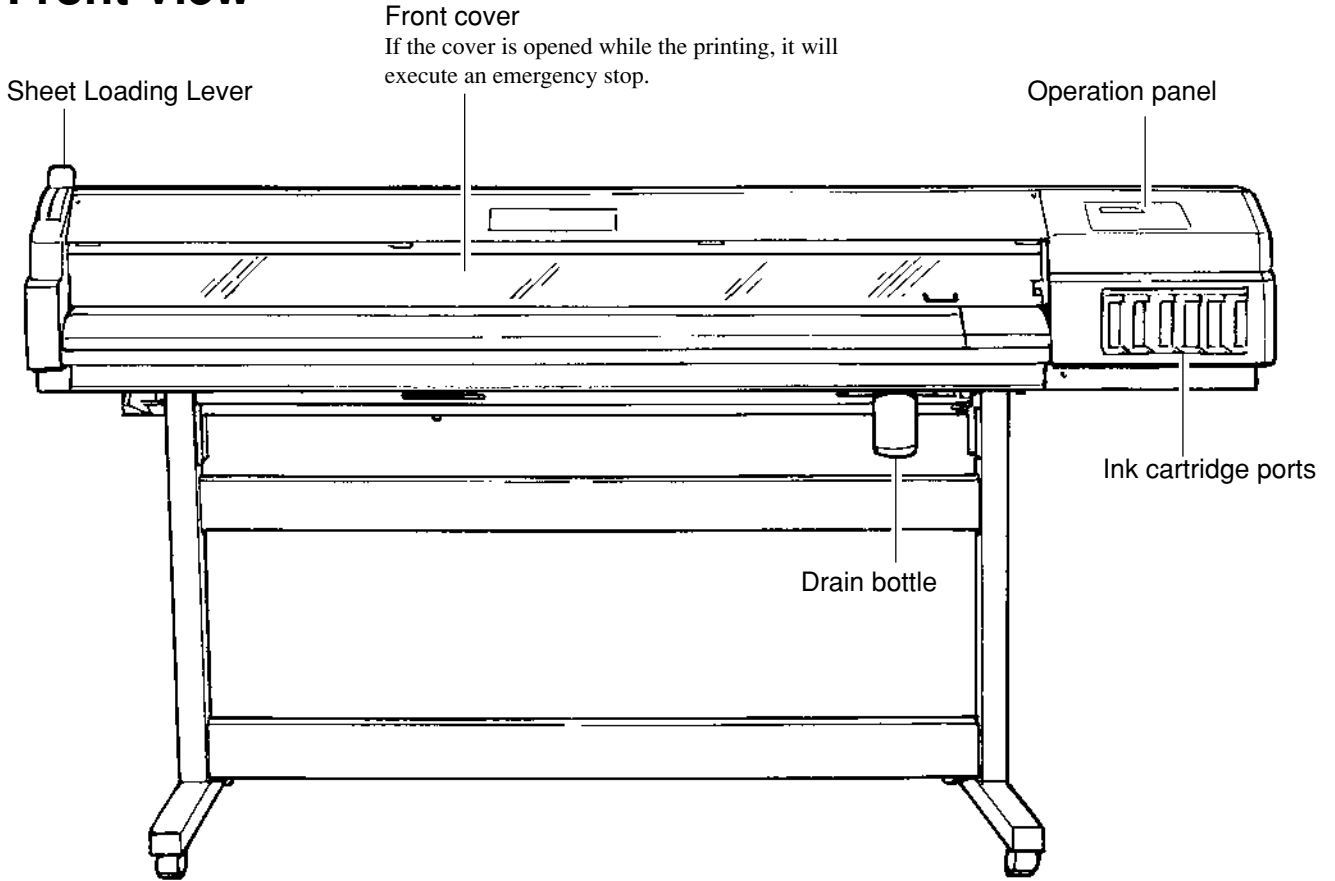

## Rear View

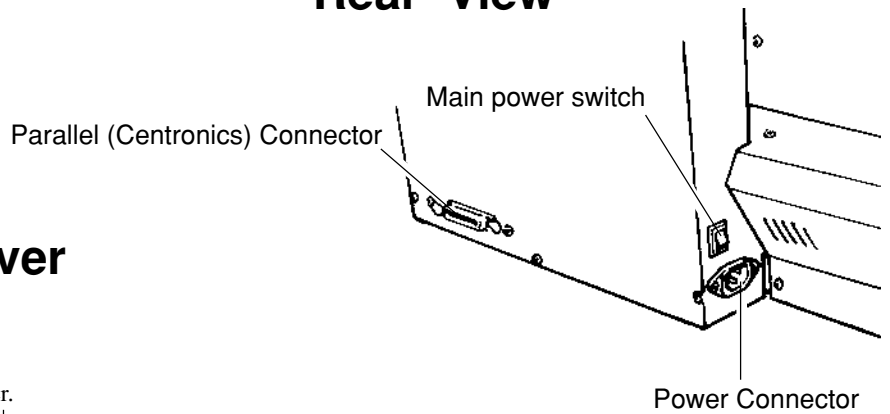

## Inside the Front Cover

Carriage

\* When not printing, this stays inside the cover.

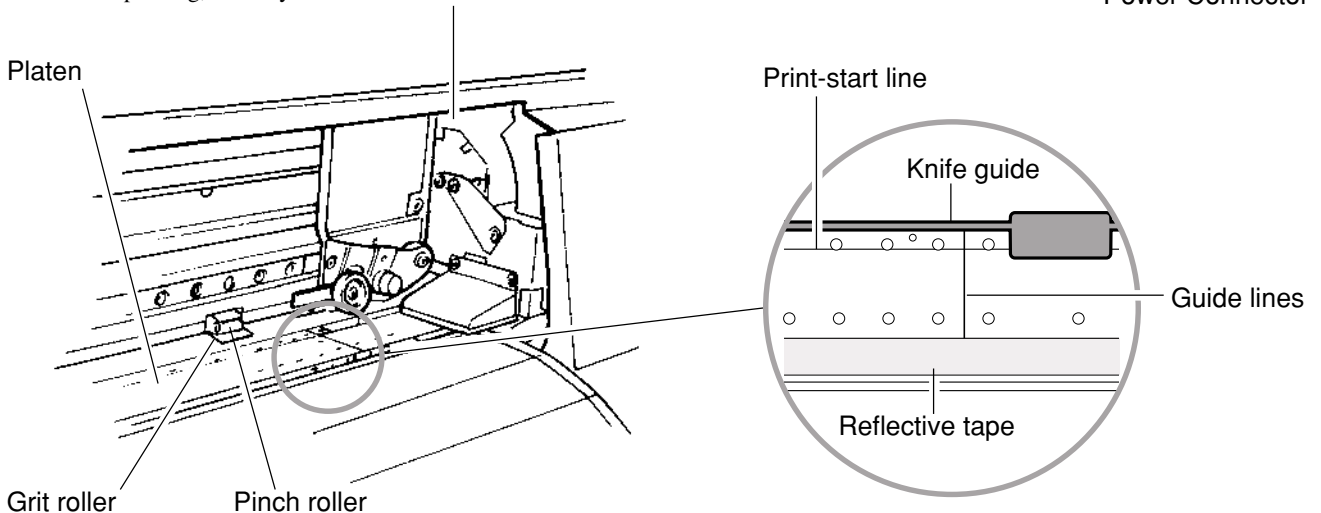

# 1-3 Setting Up and Connection

## Setting up

### CAUTION



**Unpacking, installation, and moving must be carried out by two or more persons.**

Failure to do so may result in falling of the unit, leading to injury.

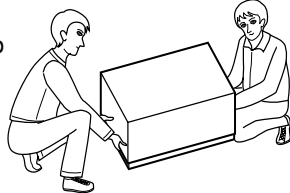

**Install in a level and stable location.**

Otherwise the unit may tip over and cause injury.

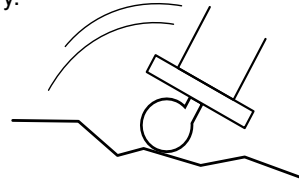

### NOTICE

Be sure to install the drain bottle before switching on the power.

Never install the unit in any of the following situations, as it could result in breakdown or faulty operation:

- Places where the installation surface is unstable or not level.
- Places with excessive electrical noise.
- Places with excessive humidity or dust.
- Places with poor ventilation, because the FJ-50/40 generates considerable heat during operation.
- Places with excessive vibration.
- Places exposed to strong illumination or direct sunlight.

Never step or stand on the stand legs, as doing so may damage them.

Do not place objects on the unit, as doing so may result in breakdown.

For an explanation of how to assemble the unit and the stand (PNS-50/40), refer to the “ASSEMBLY INSTRUCTIONS” included with the stand.

When using the unit while mounted on a stand, be sure to ensure a sufficient amount of installation space for the unit. The required installation spaces for each model are listed below.

FJ-50: 2247 mm (88-1/2") wide, 736 mm (29") depth, and 1251 mm (49-5/16") high

FJ-40: 2022 mm (79-5/8") wide, 736 mm (29") depth, and 1251 mm (49-5/16") high

# Connection

## ⚠ WARNING



**Use only with a power supply of the same rating as indicated on the unit.**  
Use with any other power supply may lead to fire or electrocution.



**Ground the unit with the ground wire.**

Failure to do so may result in risk of electrical shock in the even of a mechanical problem

## NOTICE

Before connecting the cable, make sure the computer's power and the FJ-50/40's main power switch are switched off.

Securely connect the power cord, computer I/O cable and so on so that they will not be unplugged and cause failure during operation. Doing so may lead to faulty operation or breakdown.

Arrange the power cord and interface connection cable to prevent tripping when moving around the unit.

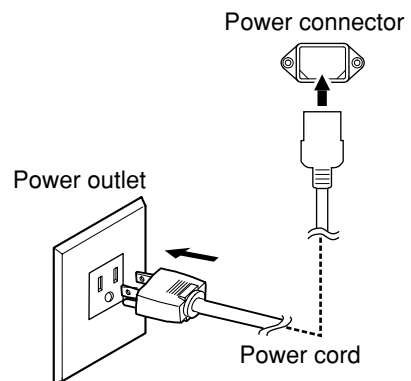
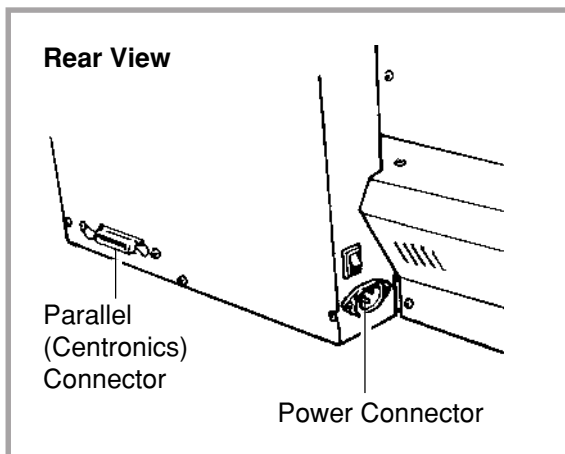

## For IBM PC or PC compatibles

Parallel connector  
Secure the cable in place with the clips.

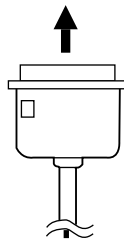

Parallel interface cable

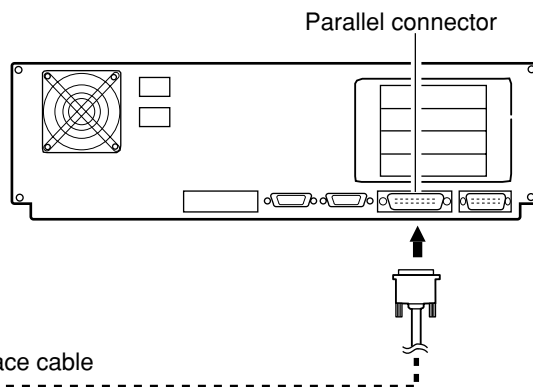

\* Cables are available separately. One which you are sure matches the model of computer being used should be selected.

## For Macintosh

Parallel connector  
Secure the cable in place with the clips.

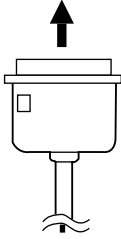

Parallel interface cable

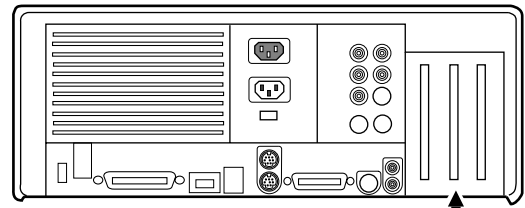

Parallel card for  
Macintosh (optional)

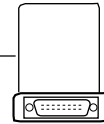



---

# 2 Basic Operation

---

## 2-1 Attach the Drain Bottle

The tube plug and the cap for the drain bottle will be needed if you must repackage the product. Please do not throw them away.

- 1** Detach the tube plug from the tube tips protruding from the bottom surface of the right-hand side of the unit.

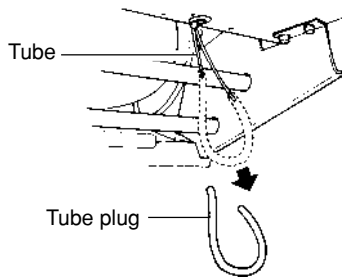

- 2** Pass the tube through the hole in the drain-bottle mounting cap and align with the threaded hole. Tighten the included screws.

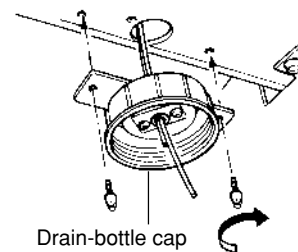

- 3** Remove the cap for the drain bottle and attach the drain bottle to the unit by screwing it on in the direction of the arrow. Line up the threads on the drain bottle with the threads on the unit, and screw on the bottle without applying excessive force. Leave this mounted unless transporting the main unit, or when it is full. Under normal use, only a small amount of ink should collect in this bottle.

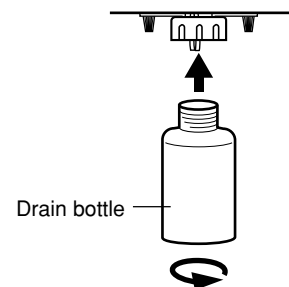

Dispose of ink in the drain bottle as described below.  
Discard any ink that has collected in the drain bottle and cap the bottle securely.



If any ink gets on your hands or clothing, wash it off as soon as possible. Ink stains may become difficult to remove if allowed to stand.

- 1** Press the [POWER] key to switch off the power.

The POWER LED goes out

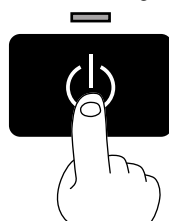

- 2** Remove the drain bottle and attach the tube plug to the tube tips instead.

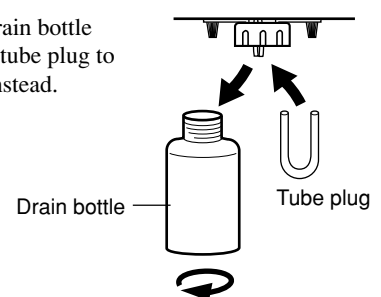

- 3** Put a water-absorbent, combustible material such as a paper or cloth into the plastic bag, and soak up the ink.

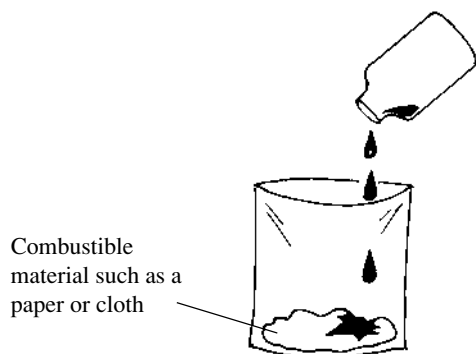

- 4** Close the plastic bag, and dispose of it as combustible rubbish.

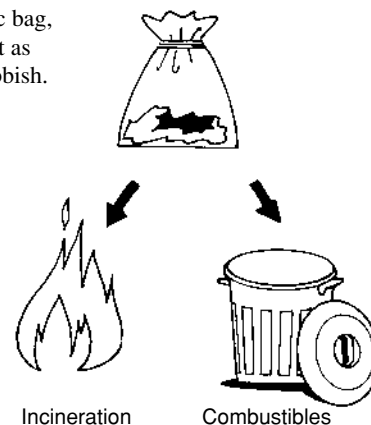

## 2-2 Installing Ink Cartridges

### CAUTION



Store ink cartridges out of the reach of children.

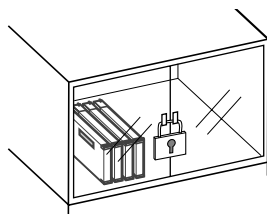

If ink contacts the eyes, flush immediately with water.



**NOTICE** Do not remove any ink cartridges except when shipping the FJ-50/40.

If ink runs out, replace immediately with an ink cartridge designed especially for the FJ-50/40 (see "3-1 Replacing the Ink Cartridges"). Do not attempt to refill and reuse an empty ink cartridge. If an ink cartridge is removed, replace it immediately with a new one.

Do not attempt to disassemble an ink cartridge.

Unused ink cartridges should be stored unopened at a temperature of -20°C (-4°F) to 40°C (104°F).

If an ink cartridge is dropped, the shock due to the fall may damage the ink cartridge and make it unusable.



- If any ink gets on your hands or clothing, wash it off as soon as possible. Ink stains may become difficult to remove if allowed to stand.
- Once an ink cartridge has been installed, do not remove it until the ink has been used up. Frequent insertion and removal may allow air to enter the ink tube and result in a drop in printing quality due to dot drop-out or the like.

Insert ink cartridges into the ink-cartridge ports. Insert it firmly, as far as it will go.

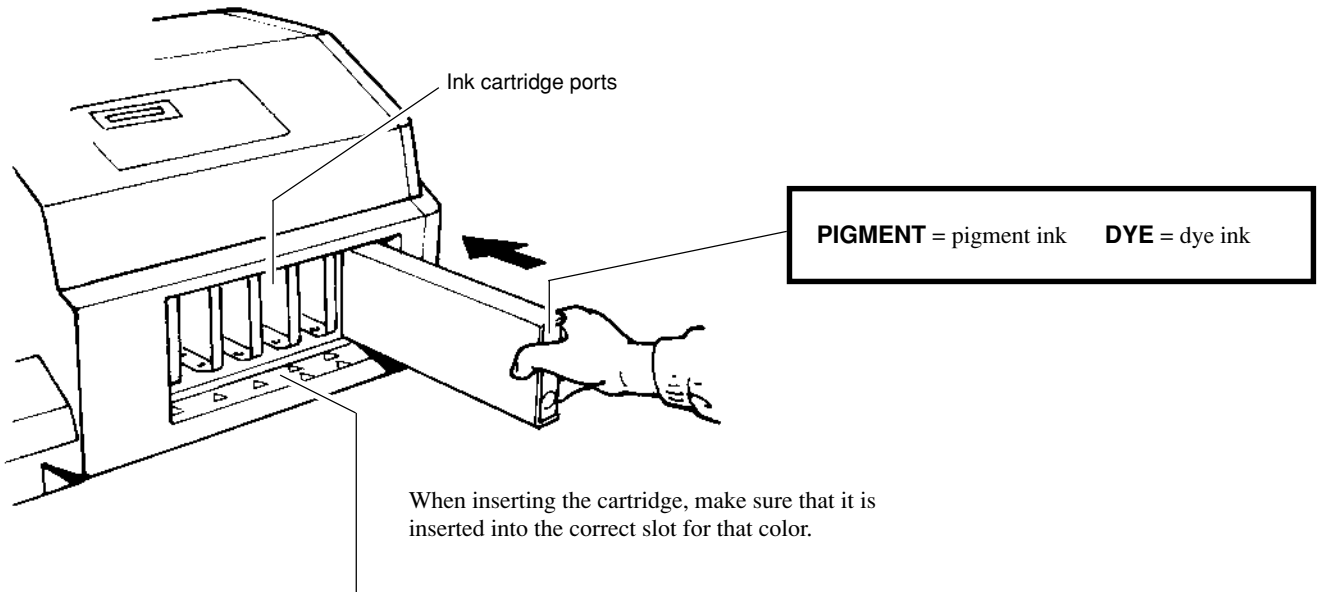

**PIGMENT CMYKLcLm (Pigment ink : cyan, magenta, yellow, black, light cyan, and light magenta)**

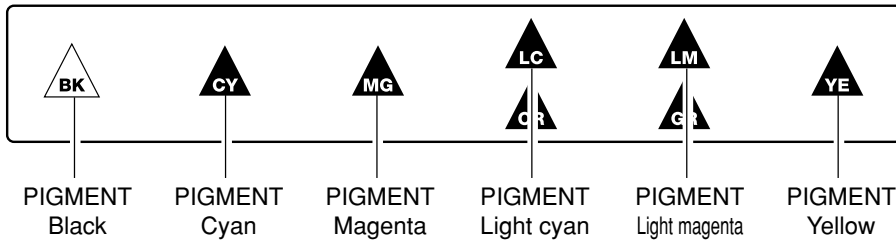

**PIGMENT CMYKOrGr (Pigment ink : cyan, magenta, yellow, black, orange, and green)**

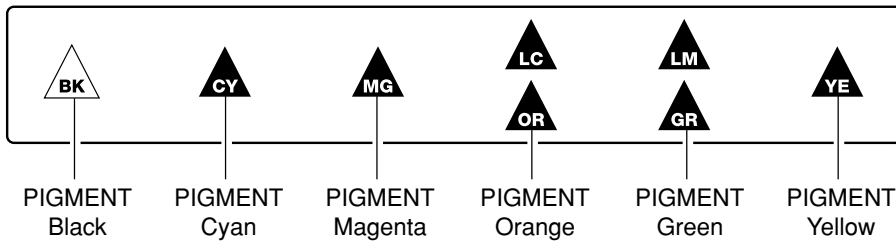

**DYE CMYKLcLm (Dye ink : cyan, magenta, yellow, black, light cyan, and light magenta)**

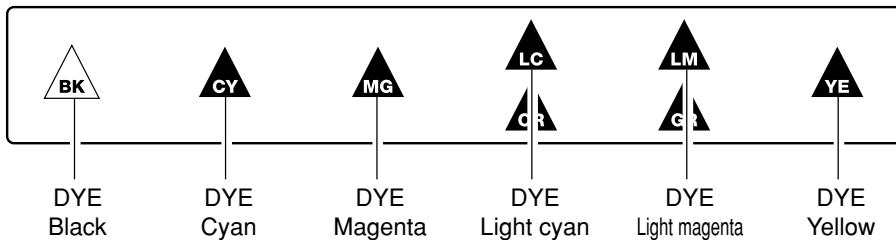

When the power is turned on for the first time, or turned on after removing the ink, the system will execute ink fill. This operation takes several minutes.

## 2-3 Powerup

Be sure to mount the drain bottle before turning on the power. Refer to section "2-1 Attach the Drain Bottle".

**1** When using for the first time turn on the main power switch on the rear of the unit.

\* Leave the main power switch on, and turn the power off and on in daily use with the sub power switch.

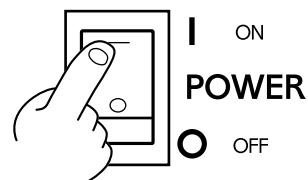

**2** Press the [POWER] key on the operation panel.

The POWER LED lights up

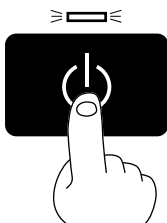

### When the power is turned on for the first time, or turned on after removing the ink

The POWER LED lights up

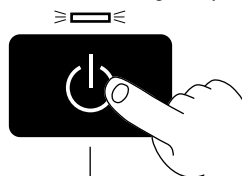

Roland FJ-50  
Ver.1.00

Roland FJ-50  
UNKNOWN INK TYPE

No ink is filled.

SELECT INK TYPE  
PIG. CMYKLcLm

Select the installed ink type and press the [ENTER] key.

PIG. CMYKLcLm/PIG. CMYKOrGr/DYE CMYKLcLm

INSTALL  
DRAIN TANK

Attach the drain tank, and press the [ENTER] key.

NOW FILLING INK

The system will execute ink fill. This operation takes several minutes.

## 2-4 Loading the Material

### ⚠ CAUTION



**Roll material must be placed at a predetermined shaft position.**

Failure to do so may result in falling of the roll, leading to injury.

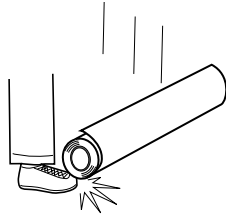

### Acceptable material widths

#### FJ-50

210 mm to 1350 mm (8-5/16" to 53-1/8")

#### FJ-40

210 mm to 1125 mm (8-5/16" to 44-1/4")

## Loading Roll Material

- Secure the retainer on the left-hand side in place at the location shown in the figure. Tighten the screw to secure in place.

\* When using roll material, the retainer on the left-hand side should always be used secured in place at the location shown in the figure.

Rear

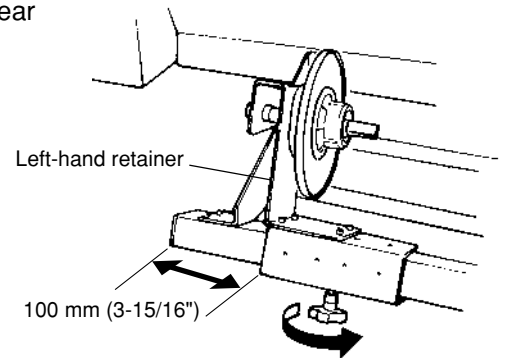

- Line up with the core diameter of the loaded roll material and refit the left- and right-hand media flanges.

Flange retaining pin

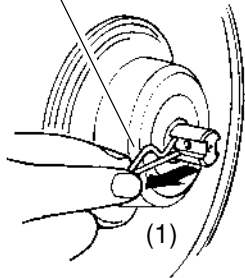

Media flange

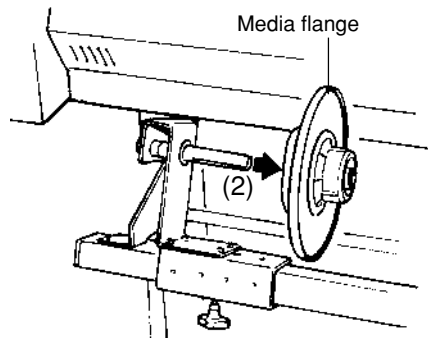

Media flange

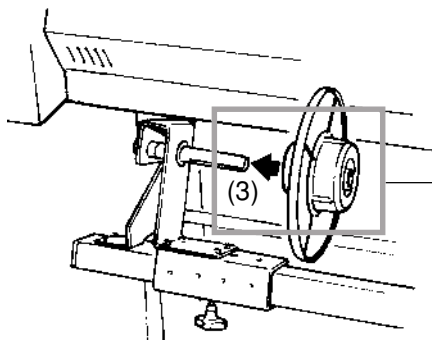
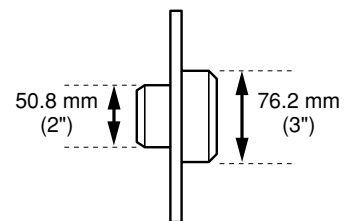

Line up the ridges and grooves.

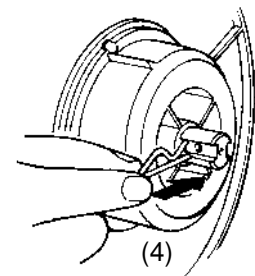
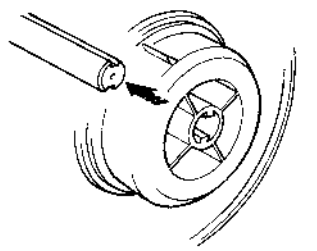

## 2 Basic Operation

**3** Place the roll material on the shaft and fit the hole at the left-hand side all the way onto the left-hand media flange.

**4** Fit the right-hand media flange all the way into the hole on the right-hand side of the roll material, and tighten the retainer screw to secure in place.

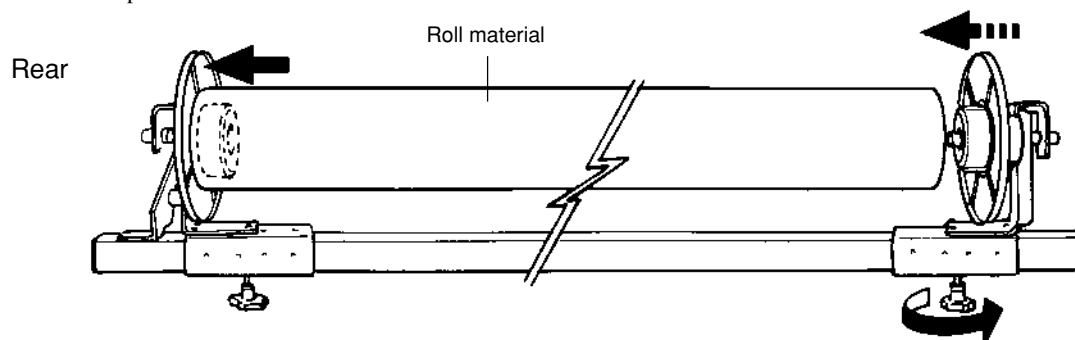

**5** Pass the end of the material through the unit from back to front.

Line up the end of the material with the lines of reflective tape.

If the front edge of the material has been cut at an angle, pull out the material so that all of the material covers the reflective tape.

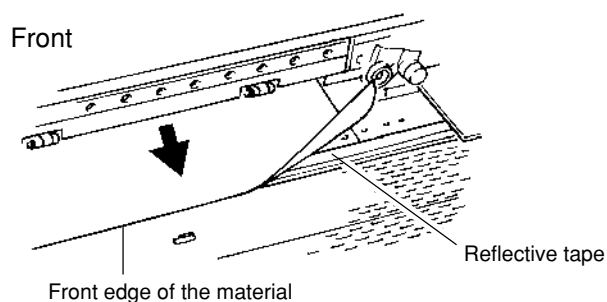

**6** With the material pulled out from the roll stretched taut with no slack, move the sheet loading lever toward LOAD. The pinch rollers lower to hold the material in place.

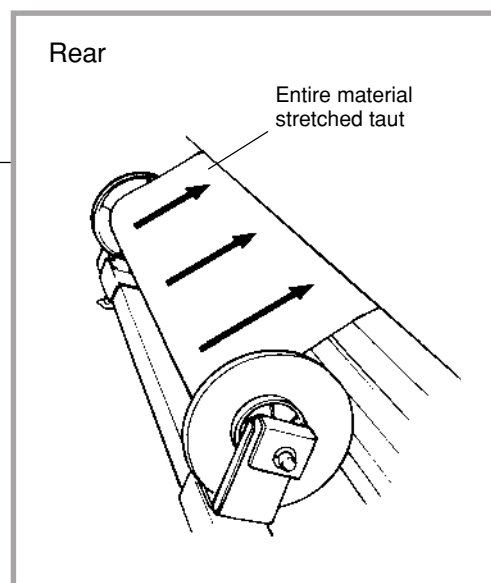
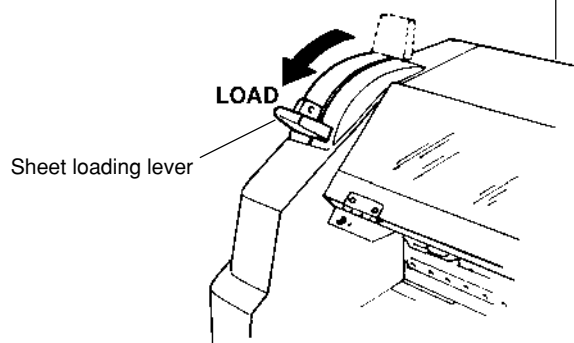

**7** Close the front cover, and press the [SETUP] key. This detects the width of the material and displays the printable width.

The SETUP LED lights up

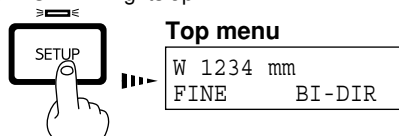

## Loading Sheet Material

- 1** Pass the material between the pinch rollers and the grit rollers as shown in the figure.

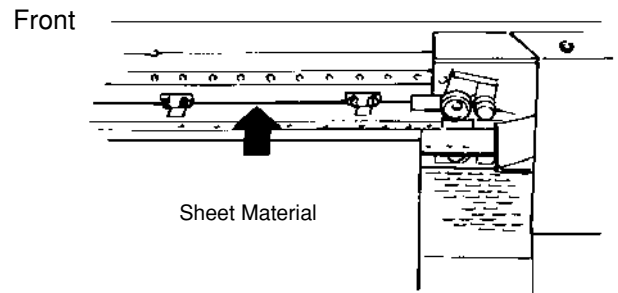

- 2** Line up the right-hand side of the material with the guide line, and line up the front edge of the material with the reflective tape.  
If the front edge of the material has been cut at an angle, pull out the material so that all of the material covers the reflective tape.

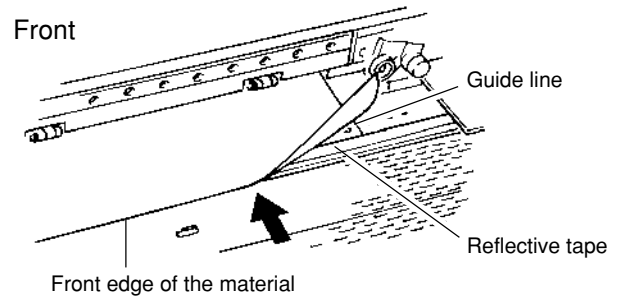

\* Be sure to line up the right-hand edge of the material with the guide line.  
If the material is not positioned correctly when the [SETUP] key is pressed, the display shows "INVALID SHEET SET SHEET AGAIN."

- 3** Move the sheet loading lever toward LOAD.  
The pinch rollers lower to hold the material in place.

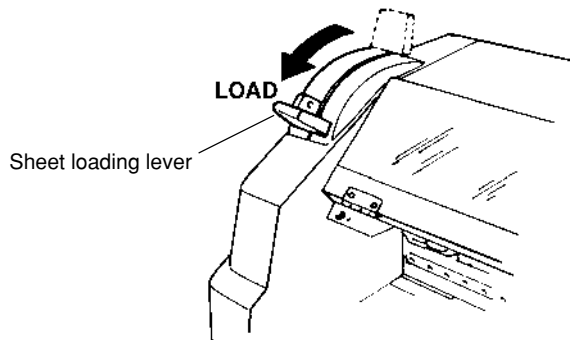

- 4** Close the front cover, and press the [SETUP] key.  
This detects the width of the material and displays the printable width.

The SETUP LED lights up

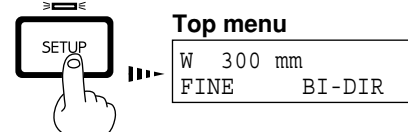

- When using sheet material, if the loaded material contacts the media flange of the back of the unit, shift the right-hand retainer to a position where the material doesn't touch the media flange.
- When transparent material is loaded, it is necessary to set [SHEET TYPE] to [CLEAR]. For more information, see "4-6 What to Do If..." (Even when the [SETUP] key is pressed, [INVALID SHEET] appears and the material cannot be detected).
- When thick material is loaded, it may adjust the head height. For more information, see "4-2 Adjusting the Height of the Printing Head."
- When changed to a different type of material, it is necessary to carry out feed correction and bidirectional correction. For more information, see "2-6 Performing Printing -- Making Corrections for Printing."
- If the sides of the material have warped, then bend back the warp or feed the warped portion to the front and perform setup again. Attempting to print with warped material may scrape the printing heads or cause the material to jam. If the printing heads become damaged or soiled as a result, printing accuracy may suffer.

## 2-5 Printing Test

Before starting to print, carry out a printing test to check the state of the head.

Problems such as missing dots may reduce the printing quality.

If the test results show a problem, carry out head cleaning to restore the head to its normal state.

**1** Load a material, then close the front cover.

**2** Press the [CLEANING] key to execute [TEST PRINT].

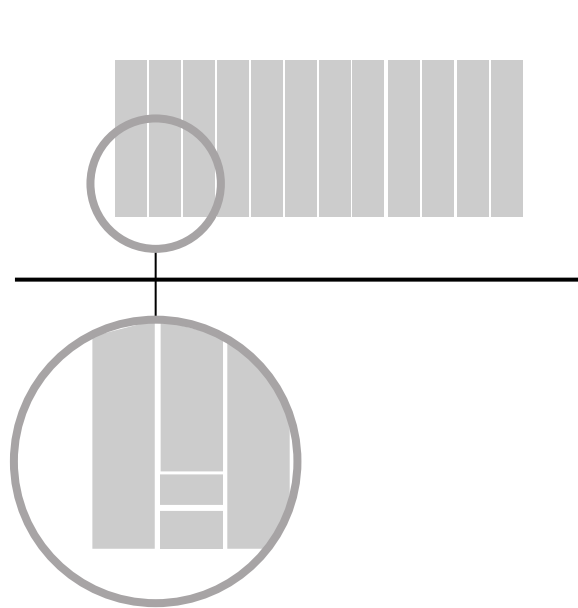
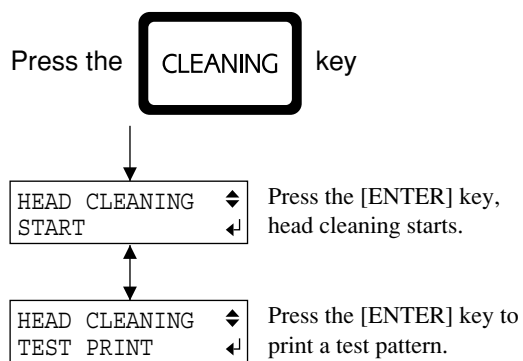

If there are any missing dots or other evidence of a drop in printing quality, clean the head (see "3-3 Cleaning the Printing Heads").



## 2-6 Printing

**NOTICE** Opening the front cover while printing is in progress causes an emergency stop. This means that printing may not be carried out correctly even if operation is resumed, due to drop-out or misalignment of the image. To pause printing for any other reason than an emergency stop, press the [PAUSE] key. Note pressing the [PAUSE] key to pause operation may result in differing image quality before and after the pause. It is a good idea to avoid pausing operation while printing is in progress whenever possible.

If you will leave the printing head being uncapped for a long time (for example, open the front cover while printing is made on the middle of platen), printing heads may get clogging and, in some case it results unrecoverable damage to the printing head.

Do not use the [▲] key to return a portion of the material that's already been printed. The pinch rollers may pass over the printed surface, smudging the ink. Also, do not use the [▲] and [▼] keys to feed and return unprinted portions many times. The grit rollers may make tracks on the material, resulting in poor printing precision.

## Downloading Printing Data

Printing or cutting is started when data is sent.

If the top menu isn't displayed, printing doesn't start even when data is sent from the computer.

### Conditions for starting printing

The material must be already set up (with the SETUP LED lighted), and the display must show the top menu.

### Top menu

W 1234 mm
FINE BI-DIR

If another menu screen is displayed, press the [SETUP] key to go back to the top menu.

(Pressing the [SETUP] key when another menu screen is displayed does not cancel the set-up for the material.)

## Pausing Printing Operations

Press the [PAUSE] key.

The PAUSE LED lights up

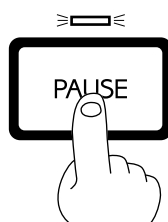

## To resume printing

Press the [PAUSE] key.

The PAUSE LED goes out

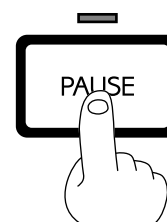

## Stopping Printing Operations

1 Press the [PAUSE] key.

The PAUSE LED lights up

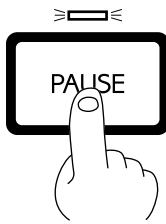

2 Halt transmission of printing instructions from the computer.

3 Hold down the [SETUP] key for one second or longer. Any remaining data is cleared.

The SETUP LED goes out

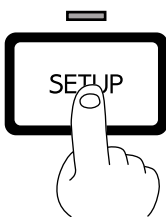

## If the "INK EMPTY" message appears while printing

If it becomes necessary to replace the ink cartridge while printing is in progress, the buzzer sounds and the following message is displayed. Please replace the ink cartridge.

If this message is ignored and printing is continued without replacing the ink cartridge, image quality may be adversely affected and exhibit faintness or other problems.



This indicates the ink color. The color for which ink has run out flashes.

K = Black / C = Cyan / M = Magenta /  
c = Light Cyan (O = Orange) /  
m = Light Magenta (G = Green) / Y = Yellow

1 When [INK CONTROL]'s [EMPTY MODE] is set to [LATER]

Press the [PAUSE] key to pause printing.

The PAUSE LED lights up

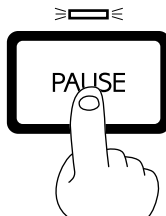

When [INK CONTROL]'s [EMPTY MODE] is set to [PROMPT]

The unit pauses automatically.

2 Pull out the cartridge for the ink color that has run out, and replace with a new cartridge (see "3-1 Replacing the Ink Cartridges").

3 Press the [PAUSE] key to resume printing.

The PAUSE LED goes out

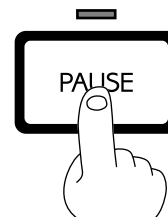

# Setting the Printing Mode

## Types of Printing Modes

Before start to print, set the printing mode.

To set the printing mode, press the [PRINT QUALITY] key and make the setting at the [PRINT QUALITY] menu.

At the [PRINT QUALITY] menu, specify the printing mode and the setting for unidirectional or bidirectional printing.

The following printing modes are available.

### Printing Mode

PHOTO:	This is suitable for printing photographs on glossy material.
SUPER:	This is suitable for output with high image quality, such as posters. When higher image quality is require, such as when printing a photograph, set the PHOTO mode.
FINE:	This is suitable for poster-size printing. (Factory default)
NORMAL:	This performs large-size printing in a short time with high image quality.
FAST:	This is suitable for performing large-size printing in a short time.
DRAFT:	This setting is made in cases such as when checking layout.

### Printing Direction

UNI-DIRECTION:

Unidirectional printing.

Printing is performed as the carriage moves from right to left.  
Printing quality is better than with [BI-DIRECTION].

BI-DIRECTION (factory default):

Bidirectional printing.

Printing is performed as the carriage moves from right to left, and also as it returns from left to right.

Printing speed is faster than with [UNI-DIRECTION].

- The printing time for the same original data becomes increasingly longer in this sequence: DRAFT, FAST, NORMAL, FINE, SUPER, and PHOTO. Also, because the size of the output file grows larger, the processing time for creating the output file also becomes longer. It's also necessary to ensure enough memory on the computer.

## How to Set the [PRINT QUALITY] Menu

- 1 Press the [PRINT QUALITY] key.



- 2 Use the [▲] and [▼] keys to choose the printing mode.

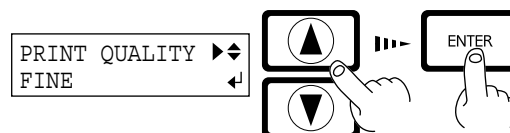

- 3 Press the [▶] key to make the setting for the printing direction.

Use the [▲] and [▼] keys to display the printing direction, then press the [ENTER] key.

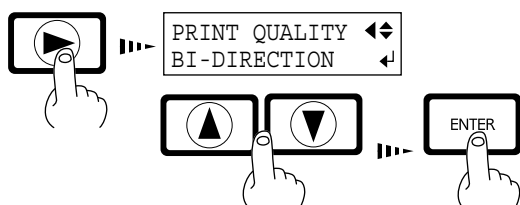

# Printing at the Desired Location

This sets the location where printing starts.  
 Normally the origin point is set at the lower-right point of the printing area.

When [SHEET TYPE] is set to [OPAQUE], the width of the printing area is set automatically (see "4-3 Printing Area").

To determine the desired printing area, follow the steps in "Setting the printing area in the left-right direction (the direction of carriage movement)" to set the width of the printing area. When [SHEET TYPE] is set to [CLEAR], the printing area is not set automatically, so set the printing area in the same way. If this setting is not made, the printing area uses the maximum value for the FJ-50/40.

Canceling setup cancels the printing area.

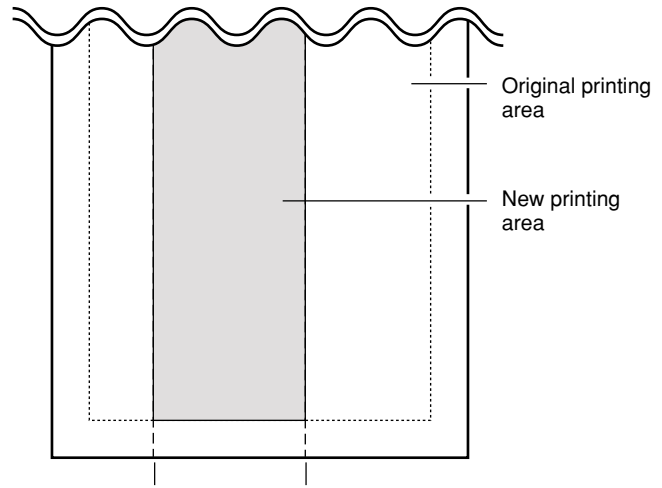

Left-hand edge of the printing area      Right-hand edge of the printing area  
 Setting the printing area in the left-right direction (the direction of carriage movement)

To change the start point for printing, use the [BASE POINT] key. At this time, the printing area does not change.  
 Follow the step in both "Specifying a location in the lengthwise direction" and "Specifying a location in the left-right direction (the direction of carriage movement)" to set the start point.

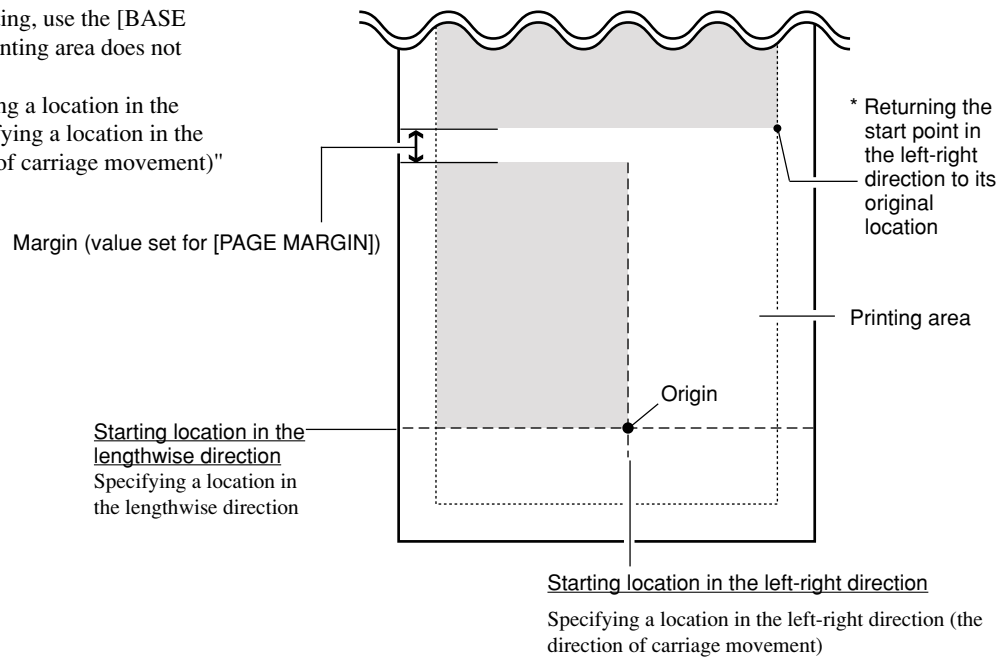

## Specifying a location in the lengthwise direction

Use the [▲] and [▼] keys to move the material to the location where you want to start printing.  
 In the figure, the next printing operation starts from the location shown.

\* For roll material, when the material has been returned toward the back of the unit with the [▲] key, manually roll the material back onto the roll so that all of the material at the back of the unit is stretched taut.

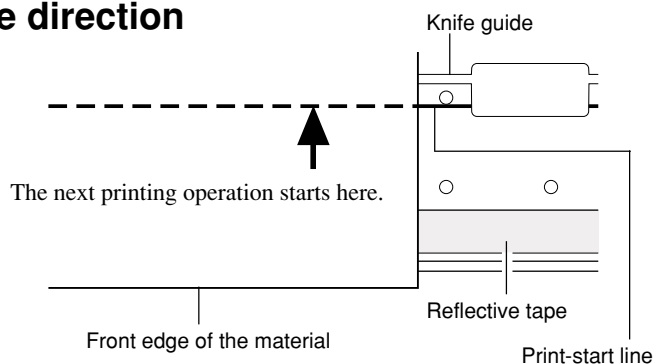

## Specifying a location in the left-right direction (the direction of carriage movement)

- 1** Press the [ ◀ ] key to move the carriage to the present starting location for printing in the left-right direction.

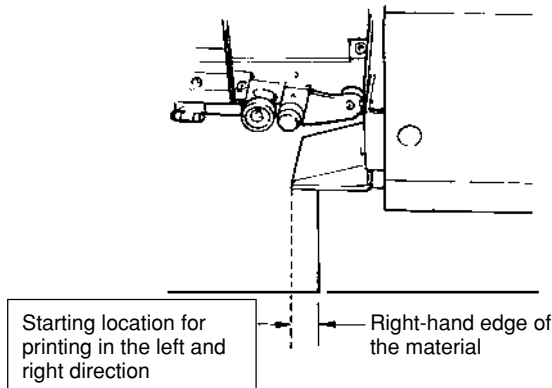

- 2** Use the [ ◀ ] and [ ▶ ] keys to line up the new starting location for printing with the left edge of the carriage.

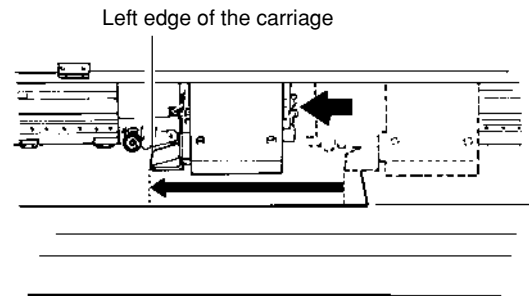

- 3** Press the [BASE POINT] key.

The BASE POINT LED lights up

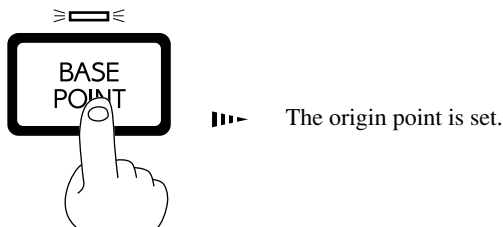

### To release the starting location that has been set...

- Set a new starting location in a different location.
- Press the [SETUP] key to cancel the setup for the material (making the SETUP LED go out).

- If the carriage moves away from the standby position when not printing, problems such as drying-out of the printing heads or dot drop-out during printing may occur. For this reason, about 60 seconds after pressing the [ ◀ ] key to move the carriage, the carriage returns to the standby position.

Also, the carriage returns to the standby position when about 20 seconds passes during this interval after the [ ◀ ] and [ ▶ ] key is released.

If the setting could not be made in within the time limit, then do the setting over again from the beginning.

- The starting location set by pressing the [BASE POINT] key is released after printing one page.

## Setting the printing area in the left-right direction (the direction of carriage movement)

\* This can be set only at the time of material setup.

- 1** Press the [MENU] key and [ ▼ ] key to make the following screen appear on the display.



- 2** Press the [ ▶ ] key to make the following screen appear on the display. The carriage indicates the present location of the right-hand edge of the printing area.

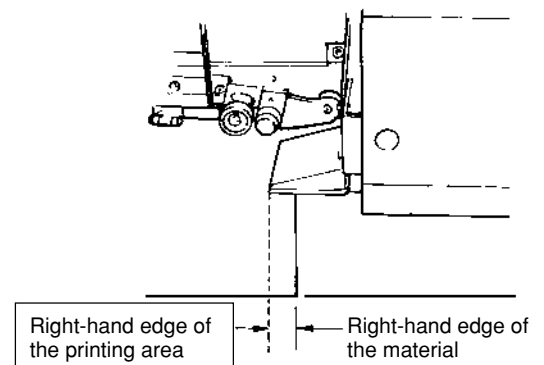
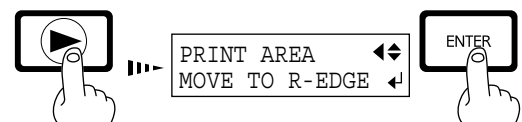

**3** Press the [▼] key to make the following screen appear on the display.  
**Setting the right-hand edge**  
 Use the [◀] and [▶] keys to move the left edge of the carriage to the location that you want to make the right-hand edge of the printing area. Press the [ENTER] key to lock in the setting with an audible beep.

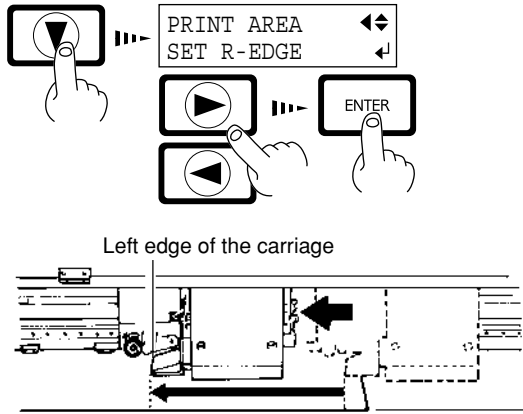

**4** Press the [▼] key to make the following screen appear on the display.  
 The carriage indicates the present location of the left-hand edge of the printing area.

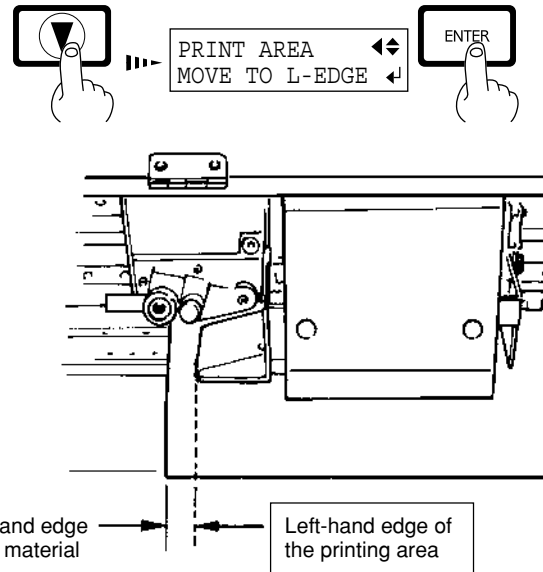

**5** Press the [▼] key to make the following screen appear on the display.  
**Setting the left-hand edge**  
 Use the [◀] and [▶] keys to move the left edge of the carriage to the location that you want to make the left-hand edge of the printing area. Press the [ENTER] key to lock in the setting with an audible beep.

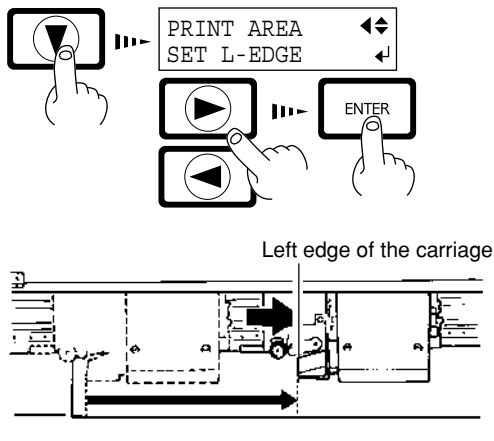

**6** Press the [▼] key to make the following screen appear on the display.  
 Press the [ENTER] key.

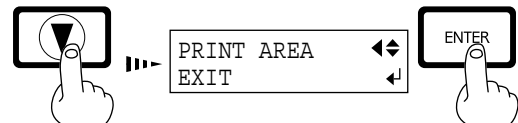

When the location of the right- or left-hand edge could not be set at the specified place, [PRINT R-EDGE (or L-EDGE) SET ERROR] appears on the display. The problem may be one of the two situations described below.

- The location specified for the left-hand edge was farther to the right than the location of the right-hand edge.

- If the carriage moves away from the standby position when not printing, problems such as drying-out of the printing heads or dot drop-out during printing may occur. For this reason, about 60 seconds after pressing the [◀] key to move the carriage, the carriage returns to the standby position. Also, the carriage returns to the standby position when about 20 seconds passes during this interval after the [◀] and [▶] key is released. If the setting could not be made in within the time limit, then do the setting over again from the beginning.
- After setting the printing area, pressing the [SETUP] key to cancel the setup for the material (making the SETUP LED go out) cancels the printing area that has been set.
- Using [PRINT AREA] to set the printing area when the starting location in the left-right direction has been specified with the [BASE POINT] key, the setting made with the [BASE POINT] key is canceled.

# Making Corrections for Printing

## Feed Correction

This corrects for errors in the amount of feed of the grit rollers due the type of material.

Be sure to make this setting when you have replaced the material with a different type.

Correcting the amount of feed improves the dot-positioning accuracy in the feed direction, which can help enhance image quality.



When performing test printing for feed correction, load the material correctly (see "2-4 Loading the Material"). If the material is not loaded correctly, an accurate correction value may not be output.

- 1** Press the [MENU] key and [▼] key to make the following screen appear on the display.

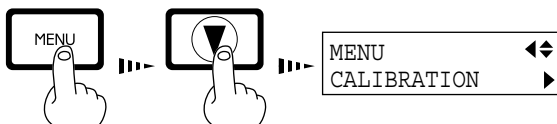

- 2** Press the [▶] key to make the following screen appear on the display.



- 3** Press the [ENTER] key to start printing a test pattern.

- 4** Check the test pattern and choose a value with no displacement.

\* Printing a Pattern in Steps of 0.10%

Test pattern

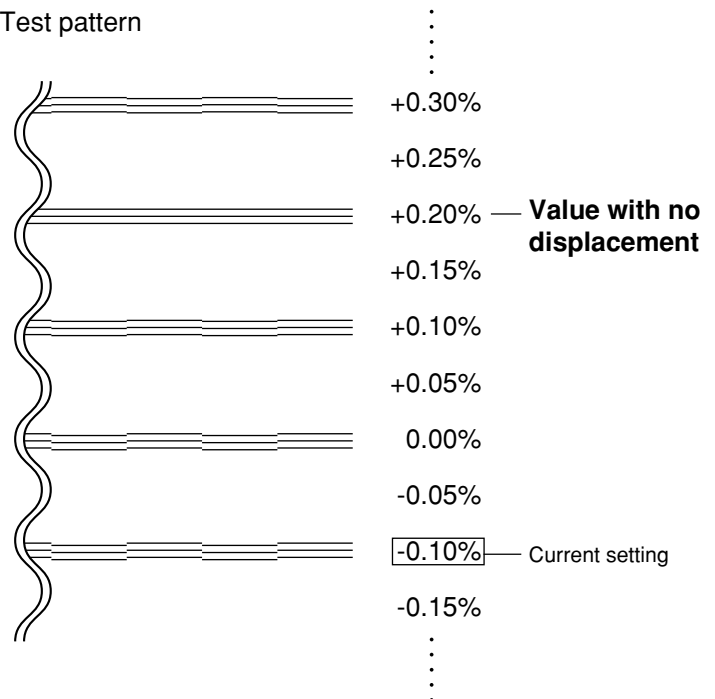

- 5** Press the [▼] key to make the following screen appear on the display.

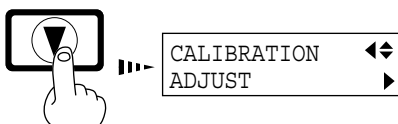

- 6** Press the [▶] key to make the following screen appear on the display.

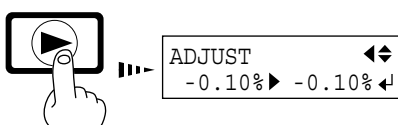

- 7** Use the [▲] and [▼] keys to set the value you checked in step 4, then press the [ENTER] key.

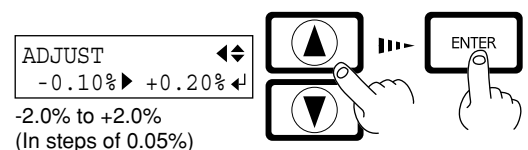

\* Test printing prints the pattern in steps of 0.10%. You can make the setting for steps of 0.05% on the display, but you should set the correction value to an adjust chosen from the test pattern.

## Bidirectional Correction

\* Only when the printing direction at the [PRINT QUALITY] menu has been set to [BI-DIRECTION] (bidirectional)

This adjusts slippage when performing bidirectional printing.

Make this adjustment when you have replaced the material with a different type or adjusted the head height.

- 1** Press the [MENU] key and [▼] key to make the following screen appear on the display.

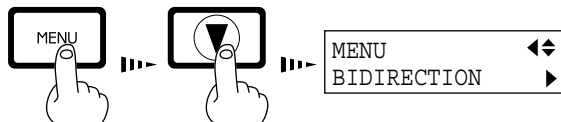

- 2** Press the [▶] key to make the following screen appear on the display.



- 3** Press the [ENTER] key to start printing a test pattern.

- 4** Check the test pattern and choose a value with no displacement.

Test pattern

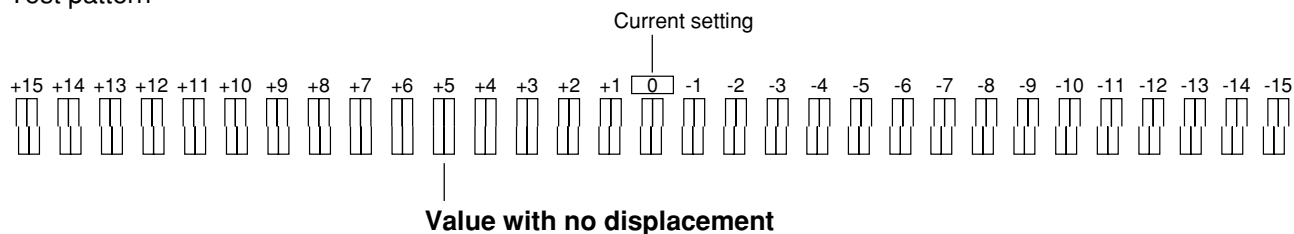

- 5** Press the [▼] key to make the following screen appear on the display.

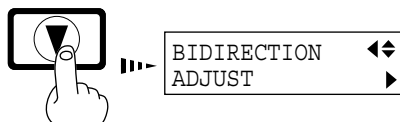

- 6** Press the [▶] key to make the following screen appear on the display.

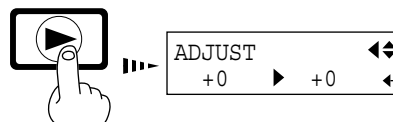

- 7** Use the [▲] and [▼] keys to set the value you checked in step 4, then press the [ENTER] key.

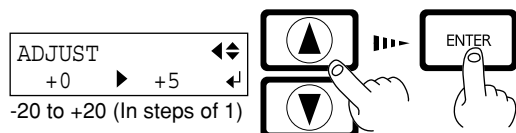



## 2-7 Ending Printing Operations

### Remove the Material

- 1** If you wish to cut off the piece of the rolled material containing the printed area, press the [SHEET CUT] key. Hold down for about 2 second. The piece is cut off at the present location of the printing-start line.

\* This operation isn't necessary when sending a material-cutting command from the computer to separate the material automatically.

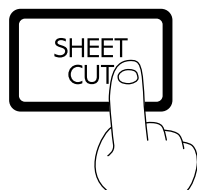

- 2** Press the [SETUP] key. Hold down for about 1 second.

The SETUP LED goes out

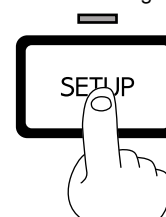

- 3** Move the sheet loading lever toward the back of the unit. The pinch rollers rise to release the material.

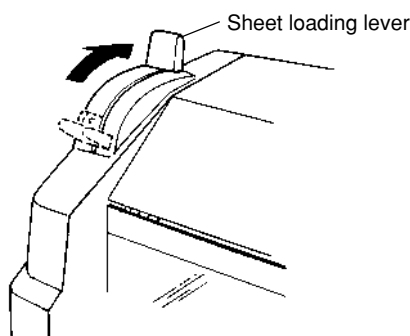

- 4** Open the front cover. To remove the material, follow the steps for loading it in reverse.

### Separating the Printed Portion

Either of two methods can be used to separate a portion that's already been printed from the roll. One method is to press the [SHEET CUT] key. The other method is to perform separation automatically by sending a material-cutting command from the computer.

#### When separating the material by pressing the [SHEET CUT] key

Holding down the [SHEET CUT] key for 2 seconds or longer severs the material at the present position of the printing-start line.

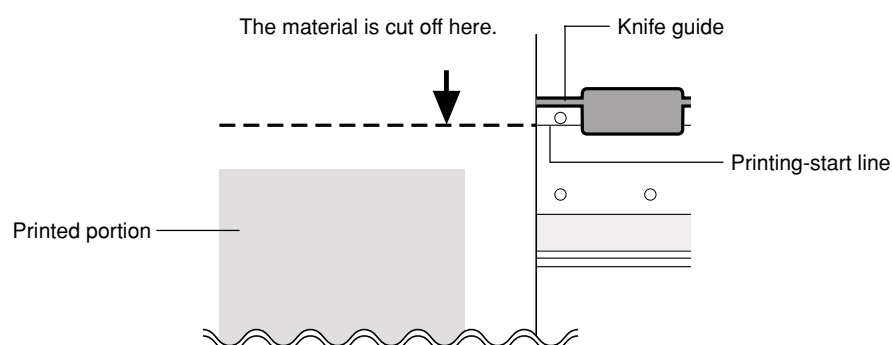

## When sending a material-cutting command from the computer to separate the material automatically

\* When the material-cutting command has not been set to "enabled" at the computer, automatic separation of the material is not performed, even when the following setting is made.

- 1** Press the [MENU] key and [▼] key to make the following screen appear on the display.

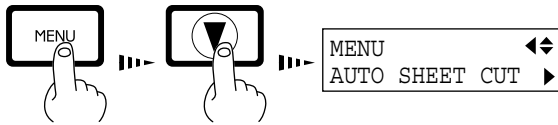

- 2** Press the [▶] key to make the following screen appear on the display.

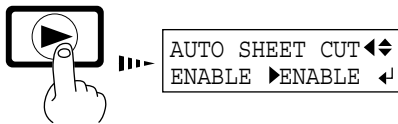

- 3** Use the [▼] key to select [DISABLE], then press the [ENTER] key.

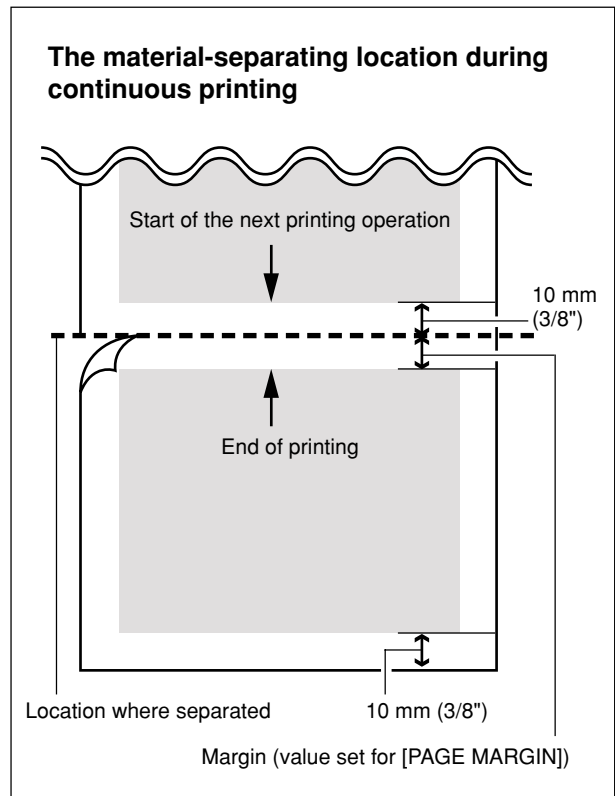
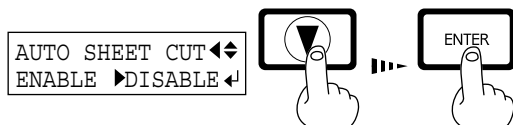

## 2-8 When Not in Use...

**NOTICE** When not in use, move the sheet loading lever toward the back of the unit to leave the pinch rollers in the raised state. The pinch rollers may be deformed if allowed to remain in the lowered state.

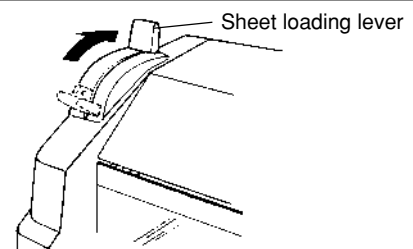

## Power Off in Daily Operation

- 1 If the SETUP LED is lighted, press the [SETUP] key. Hold down for about 1 second.

The SETUP LED goes out

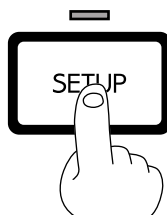

- 2 Move the sheet loading lever toward the back of the unit and remove the material.

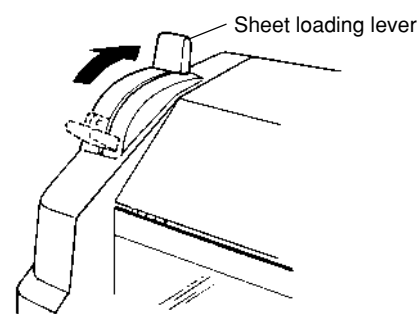

- 3 Press the [POWER] key to switch off the power. The carriage moves to the standby position and the head is capped. If the carriage is already at the standby position, no movement takes place.

The POWER LED goes out

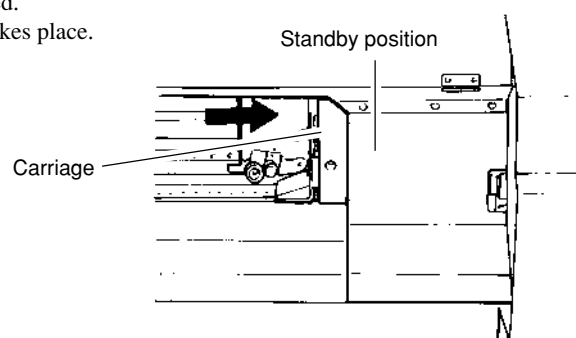
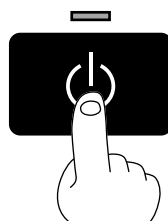

## When Not in Use for a Prolonged Period...

**NOTICE** Do not switch off the main power with the printing head in an uncapped state (i.e., while the carriage is on the platen). If you leave the carriage uncapped for a long time, doing so may result in clogging of the printing head, making it unusable. Before switching off the main power, be sure to press the [POWER] key to switch off the sub power for the FJ-50/40.

- 1 After carrying out steps 1 to 3 in "Power Off in Daily Operation," turn off the main power switch.

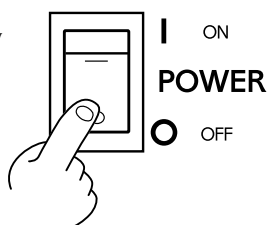

- 2 Unplug the power cord from the electrical outlet.

\* If the unit will be out of use for a month or longer, follow steps 1 through 9 of "3-7 When Moving the Unit..." to wash the printing heads. Head washing requires three optionally available cleaning cartridges.

## 2-9 Other Functions

### Performing Overprinting

This prints the same image superimposed over the same location a number of times.

When printing materials such as fabric, colors may not come out well with just a single printing pass. Overprinting can achieve darker printing results.

You can choose either [2] (two passes) or [3] (three passes) as the number of passes for overprinting.

Performing overprinting may result in ink smudges or stretch the fabric.

- 1** Press the [MENU] key and [▼] key to make the following screen appear on the display.

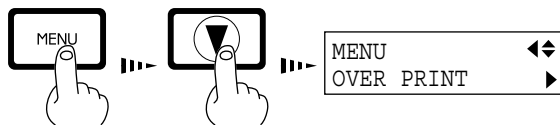

- 2** Press the [▶] key to make the following screen appear on the display.

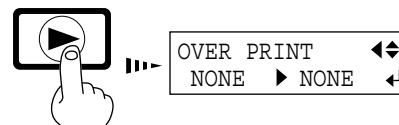

- 3** Use the [▲] and [▼] keys to choose the number of passes (two or three), then press the [ENTER] key.

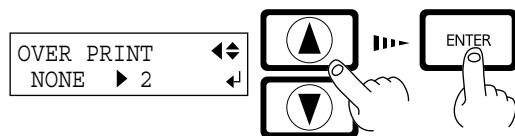

## Setting the Page Margins

This makes the setting for the margin between pages.

When outputting a number of pages continuously, you can establish a margin between the pages.

You can set this in a range of 0 mm to 100 mm (in 10-mm steps).

This is set at 10 mm when shipped from the factory.

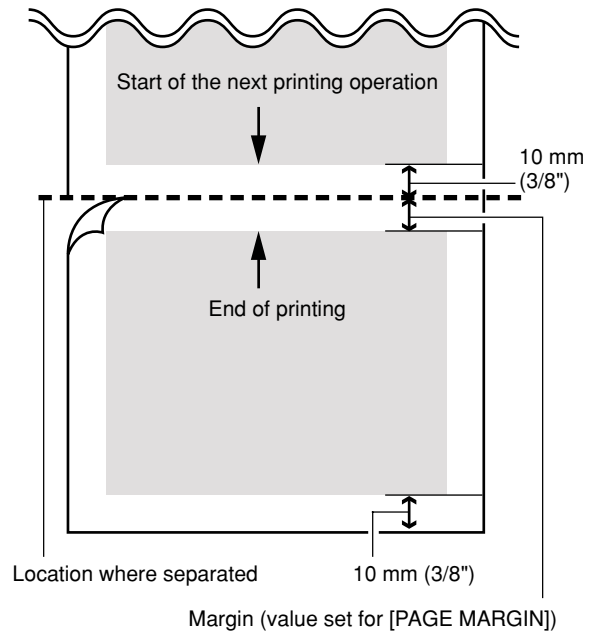
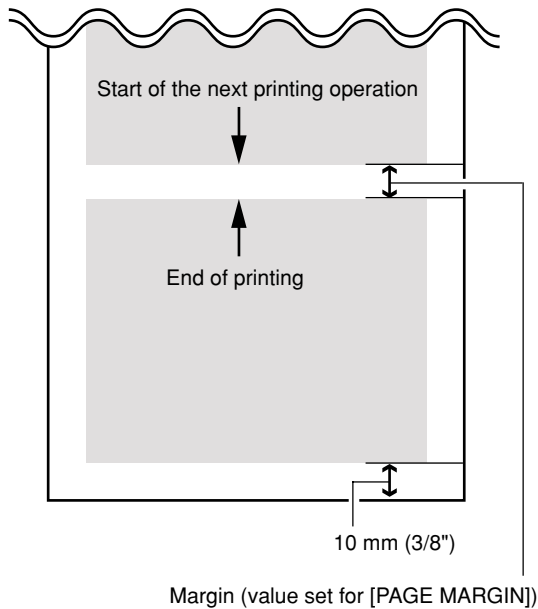

**[When the material-cutting command is enabled]**

- 1** Press the [MENU] key and [▼] key to make the following screen appear on the display.

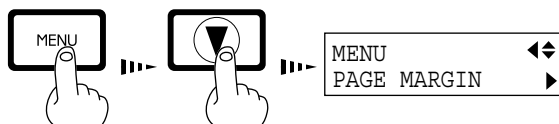

- 2** Press the [▶] key to make the following screen appear on the display.

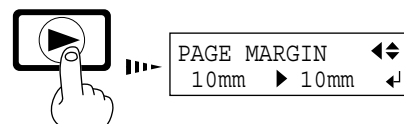

- 3** Use the [▲] and [▼] keys to set a margin, then press the [ENTER] key.

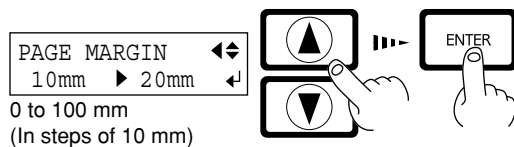

- When separating the material with the margin set at [0], the position where the material is separated and the end of printing may not match.
- When performing continuous printing with the margin set at [0], image quality just after starting to print may be poor on the second page or after. Also, dot drop-out or overlap may occur at the page borders.

# 3 Maintenance

## 3-1 Replacing the Ink Cartridges

### CAUTION



Store ink cartridges out of the reach of children.

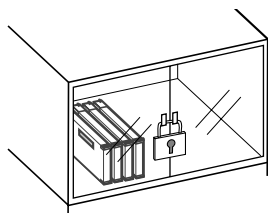

If ink contacts the eyes, flush immediately with water.



### NOTICE

Do not remove any ink cartridges except when shipping the FJ-50/40.

Use only the type of filled ink specified for the machine.

If ink runs out, replace immediately with an ink cartridge designed especially for the FJ-50/40. Do not attempt to refill and reuse an empty ink cartridge.

If an ink cartridge is removed, replace it immediately with a new one.

Do not attempt to disassemble an ink cartridge.

Unused ink cartridges should be stored unopened at a temperature of -20°C (-4°F) to 40°C (104°F).

If an ink cartridge is dropped, the shock due to the fall may damage the ink cartridge and make it unusable.

When removing an ink cartridge, do not rush. Detach the cartridge gently. Sudden movement when detaching may cause ink to be spilled.



- If any ink gets on your hands or clothing, wash it off as soon as possible. Ink stains may become difficult to remove if allowed to stand.
- Once an ink cartridge has been installed, do not remove it until the ink has been used up. Frequent insertion and removal may allow air to enter the ink tube and result in a drop in printing quality due to dot drop-out or the like.

**1** Remove the ink cartridge from the ink-cartridge port.

**2** Insert new ink cartridge.

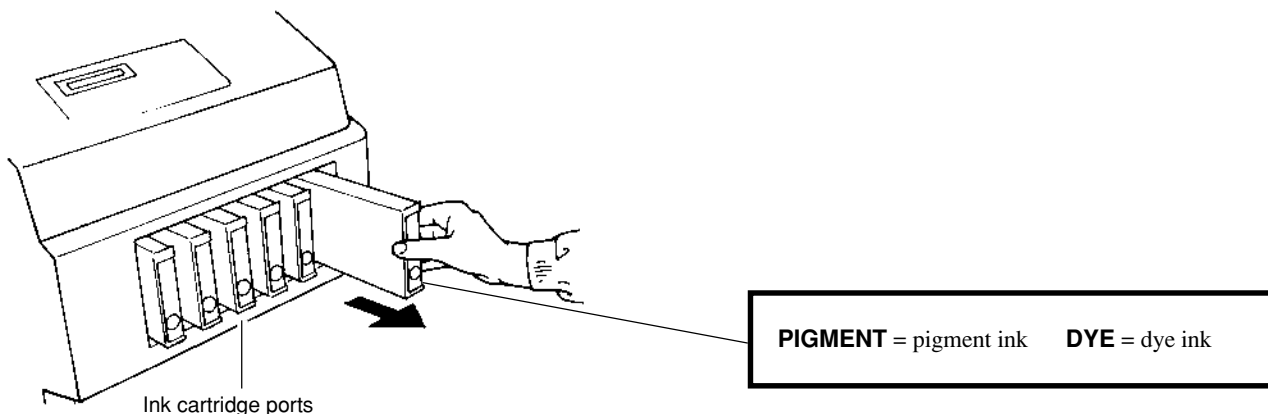

Use only the type of filled ink specified for the machine.  
The present ink type is displayed when the power is turned on.

Press the  key

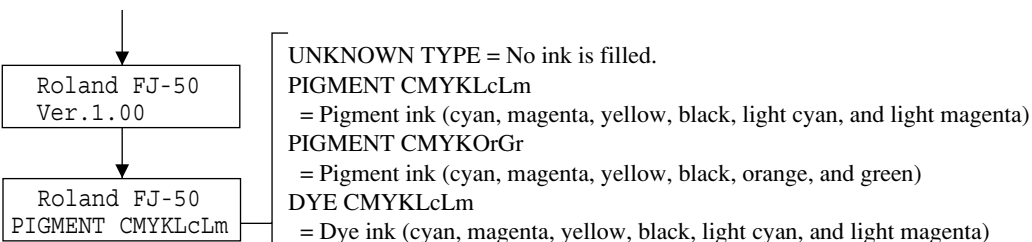

With pigment inks, do not insert ink cartridges for orange or green when using light cyan and light magenta. Also, do not insert the ink cartridges for light cyan or light magenta when using orange and green.  
If ink cartridges other than the filled type or color are installed, printing with the correct color blending will not be performed.  
To change the type of ink, you must use an optionally available cleaning cartridge to replace the ink. For more information, see "3-4 Changing the Type of Ink."

## 3-2 Remaining Ink

You can use [INK LEFT] on the display menu to check how much ink is left after the ink cartridges have been installed. Use this information as a guide for replacing the ink cartridges. If a partially used ink cartridge is removed and reinstalled, or if a partially used ink cartridge is installed, the cartridge is taken to be unused, and the displaced amount of remaining ink is not true.

- 1** Press the [MENU] key and [▼] key to make the following screen appear on the display.

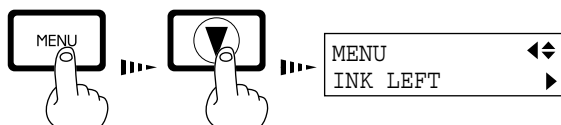

- 2** Press the [▶] key to make the following screen appear on the display. The fewer the markers, the less is the amount of ink left.

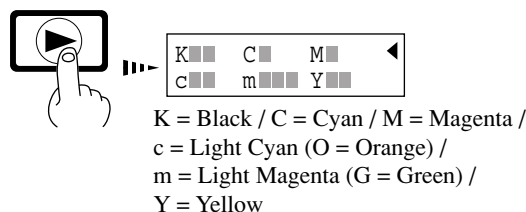

Remaining ink

Much

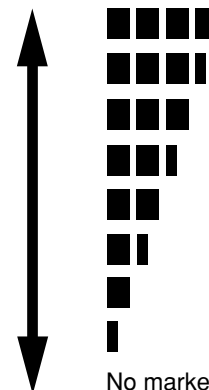

Little

## 3-3 Cleaning the Printing Heads

Switching on the sub power automatically performs maintenance operations, including cleaning of the printing head. This means that there is normally no need to perform cleaning otherwise.

If drop-out occurs with printed images, clean the printing head.

\* After cleaning, carry out a printing test. Load material.



The cleaning causes a certain amount of head wear and also consumes a certain amount of ink, so use should be kept to a minimum.

[POWERFUL] results in faster head wear and also uses up much ink. (Performing cleaning from the [POWERFUL] menu uses up about 57 cc of ink for six colors. This is because the process discharges all ink in the ink tube and replaces it with fresh ink.)



- 1** Press the [CLEANING] key to make the following screen appear on the display. Press the [ENTER] key, head cleaning starts.

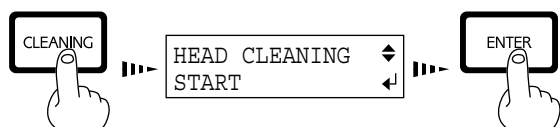

- 2** When head cleaning ends, press the [▼] key to display the screen shown in the figure. Press the [ENTER] key to start the printing test.

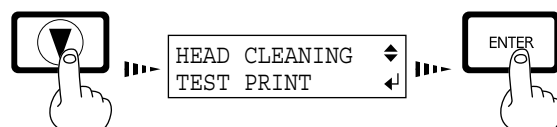

- 3** Refer to "2-5 Printing Test" and check the printing-test results. If a problem is found, repeat the cleaning.

### If drop-out persists even after carrying out cleaning several times

- 1** Press the [MENU] key and [▼] key to make the following screen appear on the display.



- 2** Press the [▶] key to make the following screen appear on the display. Press the [ENTER] key, head cleaning starts ([POWERFUL]).



- 3** When head cleaning ends, press the [▼] key to display the screen shown in the figure. Press the [ENTER] key to start the printing test.



- 4** Refer to "2-5 Printing Test" and check the printing-test results. If a problem is found, repeat the cleaning.

(The [NORMAL] menu item for [HEAD CLEANING] does the same thing as [HEAD CLEANING] - [START] displayed when the [CLEANING] key is pressed.)

### If performing cleaning several times at the [POWERFUL] menu does not correct the drop-out problem

If performing cleaning several times at the [POWERFUL] menu does not correct the drop-out problem, use the included cleaning kit. For information on how to use the cleaning kit, refer to the documentation included with the kit.

If drop-out persists even after performing cleaning with the cleaning kit, consult your authorized Roland DG Corp. dealer or service center.

The heads are consumable parts. The useful life is 2 billion dots per nozzle.

# 3-4 Changing the Type of Ink

When changing the type of ink in use, replace the ink.  
 Ink replacement requires three optionally available cleaning cartridges.

**1** Press the [MENU] key and [▼] key to make the following screen appear on the display.

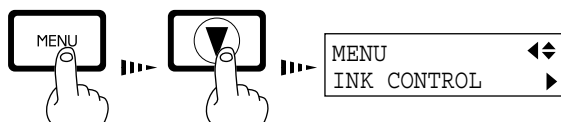

**2** Press the [▶] key to make the following screen appear on the display.



**3** Use the [▼] key to select [CHANGE INK SET], then press the [▶] key.



**4** Use the [▲] and [▼] keys to select the new type of ink to use, then press the [ENTER] key.

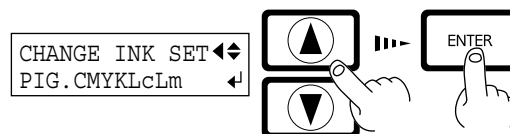

- PIG. CMYKLcLm  
(Pigment ink : cyan, magenta, yellow, black, light cyan, and light magenta)
- PIG. CMYKOrGr  
(Pigment ink : cyan, magenta, yellow, black, orange, and green)
- DYE CMYKLcLm  
(Dye ink : cyan, magenta, yellow, black, light cyan, and light magenta)

**5** When the display shown in the figure appears, discard the discharged ink in the drain bottle.

\* Be sure to discard the discharged ink.  
 Attempting to replace the ink while discharged ink remains may cause discharged ink to overflow from the bottle.

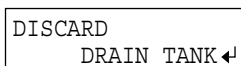

**6** Mount the drain bottle and press the [ENTER] key to display the screen shown in the figure.

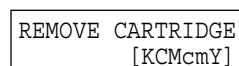

**7** When all ink cartridges have been removed, ink replacement starts. Follow the messages on the display to carry out the procedure.

-----  
 Messages appearing during ink replacement



Insert a cleaning cartridge into the ink cartridge port for the flashing color.

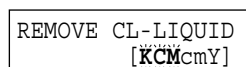

Remove the cleaning cartridge from the ink cartridge port for the flashing color.

K = Black C = Cyan M = Magenta c = Light Cyan (O = Orange)  
 m = Light Magenta (G = Green) Y = Yellow

**8** When the display shown in the figure appears, insert the ink cartridge to be newly used.

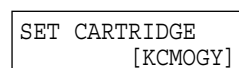

**9** When the display shown in the figure appears, ink replacement is finished. Press the [SETUP] key to go back to the top menu.



## 3-5 How to Replace the Separating Knife

### ⚠ CAUTION



**Do not touch the tip of the separating knife with your fingers.**  
Doing so may result in injury.



**Make sure the power to the unit is off before attempting to replace the separating knife.**  
Doing so may result in injury.

If the separating knife, replace it with the replacement blade included with the FJ-50/40.

- 1** Press the [POWER] key to switch off the power.

The POWER LED goes out

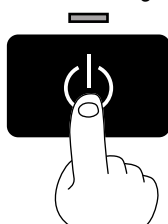

- 2** Turn off the main power switch.

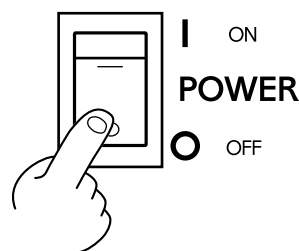

- 3** Remove the separating knife.  
(1) Loosen the screw until it slips out.  
(2) Grasp the screw portion, and slowly pull it out in the direction of the arrow.  
\* Do not pull back while doing this.

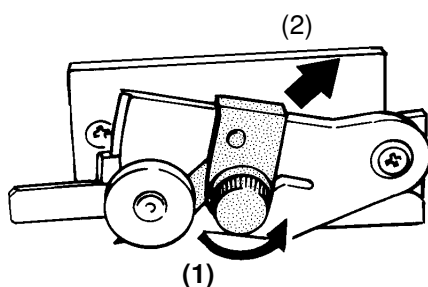

If the blade remains in the carriage, use commercially available tweezers to remove it.

- 4** Replace with a new knife.

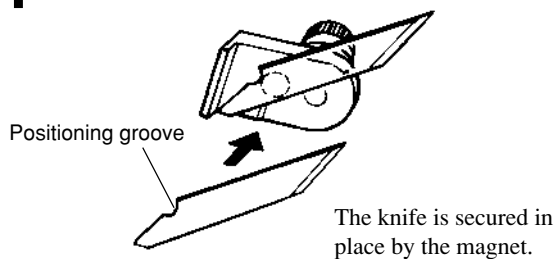

- 5** Install the separating knife.  
(1) Grasp the screw portion and slowly insert it into the groove.  
\* Take care to ensure that the knife does not slip  
(2) Tighten the screw.

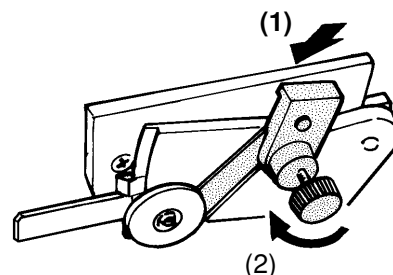

## 3-6 Cleaning

---

**NOTICE**

When performing cleaning, turn off the main power switch.

\* Before turning off the main power, press the [POWER] key to switch off the sub power.

---

Never lubricate the mechanisms.

---

Do not clean with solvents (such as benzine or thinners).

---

Periodically clean the platen. Attractive printing may become impossible if the platen is soiled.

---

Do not touch the printing heads or allow the printing heads to come in contact with anything except ink.

---

### Cleaning the body

Use a cloth moistened with water then wrung well, and wipe gently to clean. Wipe the operation panel and display gently with a clean, soft cloth.

### Cleaning the platen

Use a cloth moistened with water then wrung well, and wipe gently to clean.

### Cleaning the grit rollers

Use a commercially available brush to remove dust and other detritus. Brush horizontally while rotating the grit rollers. Any adhering grime may prevent the material from being held in place securely.

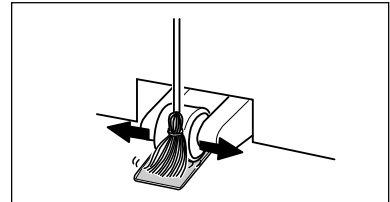

### Cleaning the pinch rollers

Use a cloth moistened with water then wrung well, and wipe gently to clean.

### Cleaning the reflective tape

If the tape becomes dirty, use a cloth moistened with water then wrung well, and wipe gently to clean.

### Cleaning the front cover

Use a cloth moistened with water then wrung well, and wipe gently to clean.

## 3-7 When Moving the Unit...

**NOTICE** When moving the unit, first carry out head washing, then secure the carriage in place. Head washing requires three optionally available cleaning cartridges.

- 1** If there is material loaded, hold down the [SETUP] key for 1 second or longer to cancel setup, then remove the material (see "2-7 Ending Printing Operations Remove the Material").

- 2** Press the [MENU] key and [▼] key to make the following screen appear on the display.

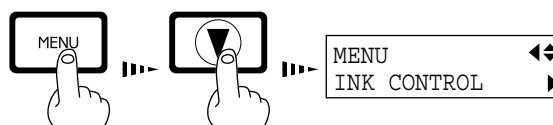

- 3** Press the [▶] key to make the following screen appear on the display.



- 4** Use the [▼] key to select [HEAD WASH], then press the [ENTER] key.



- 5** When the display shown in the figure appears, discard the discharged ink in the drain bottle.

\* Be sure to discard the discharged ink.

Attempting to replace the ink while discharged ink remains may cause discharged ink to overflow from the bottle.



- 6** Mount the drain bottle and press the [ENTER] key to display the screen shown in the figure.

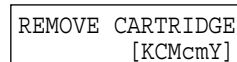

- 7** When all ink cartridges have been removed, head washing starts. Follow the messages on the display to carry out the procedure.

- 8** When the display shown in the figure appears, head washing is finished. Press the [POWER] key to switch off the sub power.

The POWER LED goes out

Messages appearing during head washing



Insert a cleaning cartridge into the ink cartridge port for the flashing color.

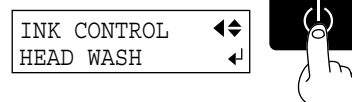

Remove the cleaning cartridge from the ink cartridge port for the flashing color.

- 9** When the POWER LED goes out, turn off the main power switch.

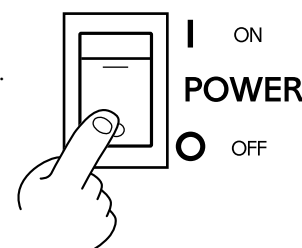

K = Black C = Cyan M = Magenta c = Light Cyan (O = Orange)  
m = Light Magenta (G = Green) Y = Yellow

Continued on the next page

### 3 Maintenance

---

- 10** Detach the power cord and the cable connecting the unit to the computer.

- 11** Remove the drain bottle.

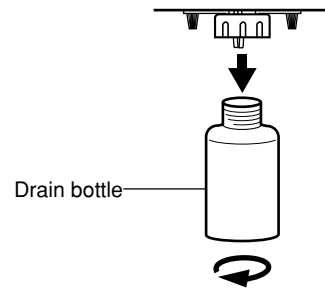

- 12** Remove the drain-bottle cap.

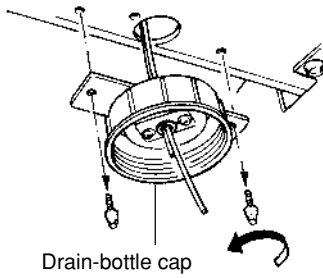

- 13** Attach the tube plug to the tube tips instead.

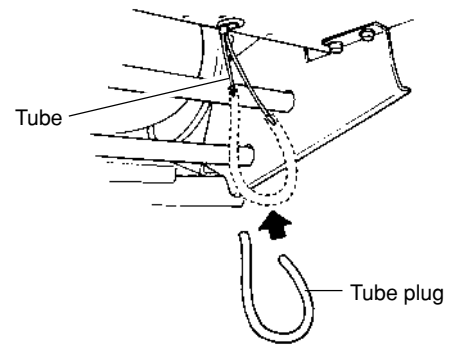

- 14** Referring to "Unpacking and Repacking" on the packing carton, secure the carriage in place and pack the unit in the carton.

# 4 User's Reference

## 4-1 Materials

\* Use genuine media for the FJ-50/40.

### Conditions for Usable Materials

- A) Maximum material thickness, including base paper (peeled-off paper)  
: 1.0 mm (0.039") (When head is raised)
- B) Maximum diameter for roll material : 180 mm (7-1/16") (surface to be printed  
or cut must face outward)
- C) Core inner diameter for roll material: 50.8 or 76.2 mm (2" or 3")
- D) Maximum weight for roll material : 20 kg (44.1 lb.)
- E) Roll material with a starting edge that is not taped down

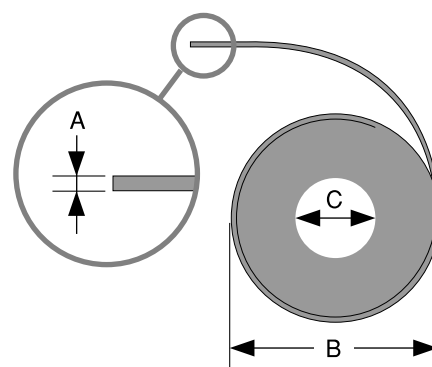

Side view of roll material

### Acceptable material widths

#### FJ-50

210 mm to 1350 mm (8-5/16" to 53-1/8")

#### FJ-40

210 mm to 1125 mm (8-5/16" to 44-1/4")

## 4-2 Adjusting the Height of the Printing Head

When using material that is thick or susceptible to warping, material feed may not proceed smoothly, or the material may jam. When such material is loaded, you can adjust the height of the printing head. To adjust the height of the head, move the lever until it clicks into place at one of the positions 1 to 3 in the figure.

This should normally be left at position 1. If printing results material feed that is not smooth because of problems such as the material jamming or the head catching on the material, adjust the height of the head.

When the height of the printing head has been adjusted, it is necessary to perform bidirectional correction (only when the printing direction for [PRINT QUALITY] has been set to [BI-DIRECTION]). For more information about bidirectional correction, see "2-6 Performing Printing - Making Corrections for Printing - Bidirectional Correction."

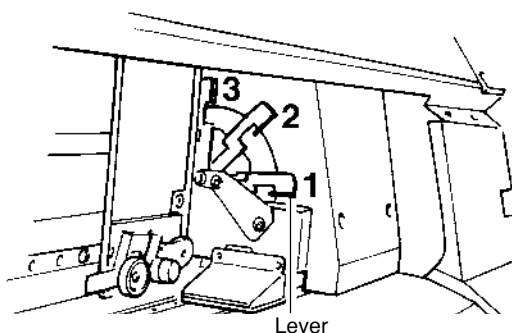
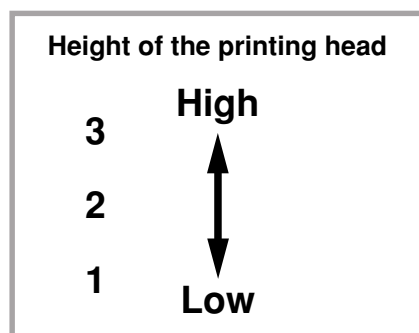

\* Be sure that the carriage is in standby position before attempting to move the lever.

# 4-3 Printing Area

The material's printable width (the direction of carriage movement) is determined by the width of the loaded material. When the [SETUP] key is pressed after loading the material, the width of the material is detected and the printing area appears on the display. The printing area is normally 10 mm (3/8") inward from the respective left- and right-hand edges of the material. When the printable width have been specified with the [PRINT AREA] menu, the margins are in accordance with these setting values.

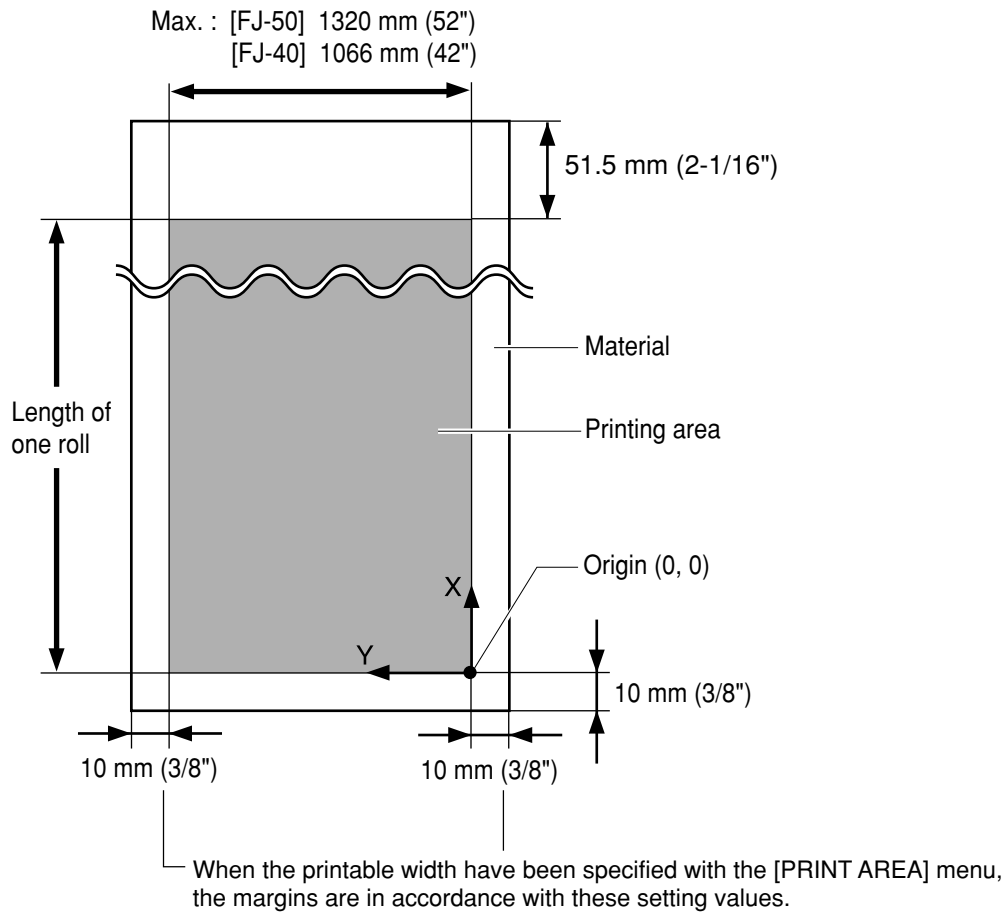



# 4-4 Display Menu Flowchart

For details about each of the menus, see the "4-5 Description of Keys and Display Menus."

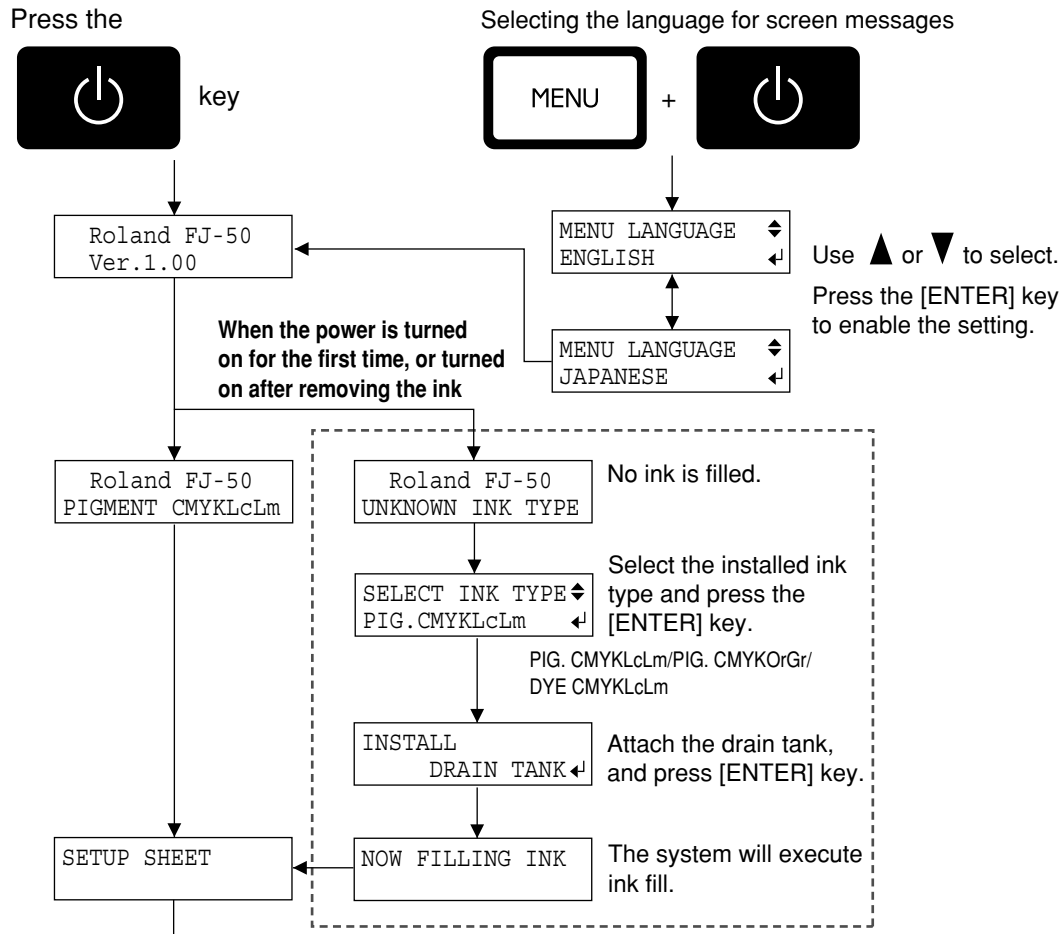

Load the material and press

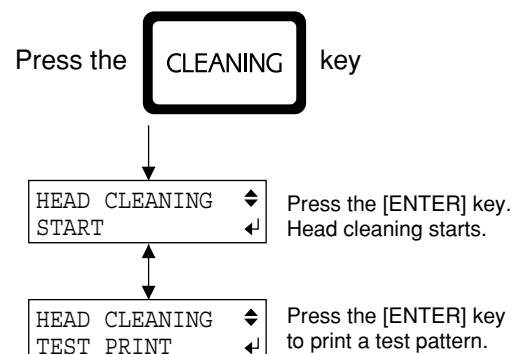
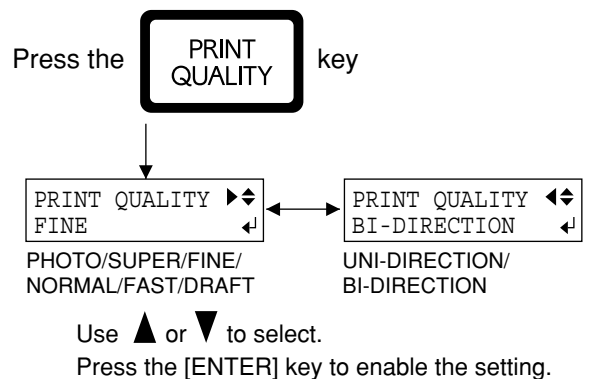
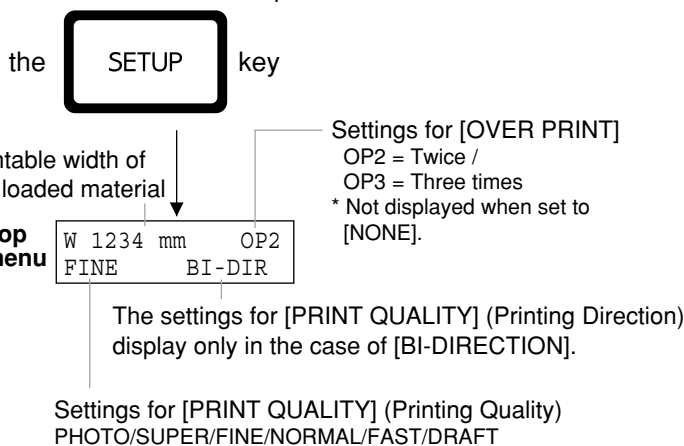

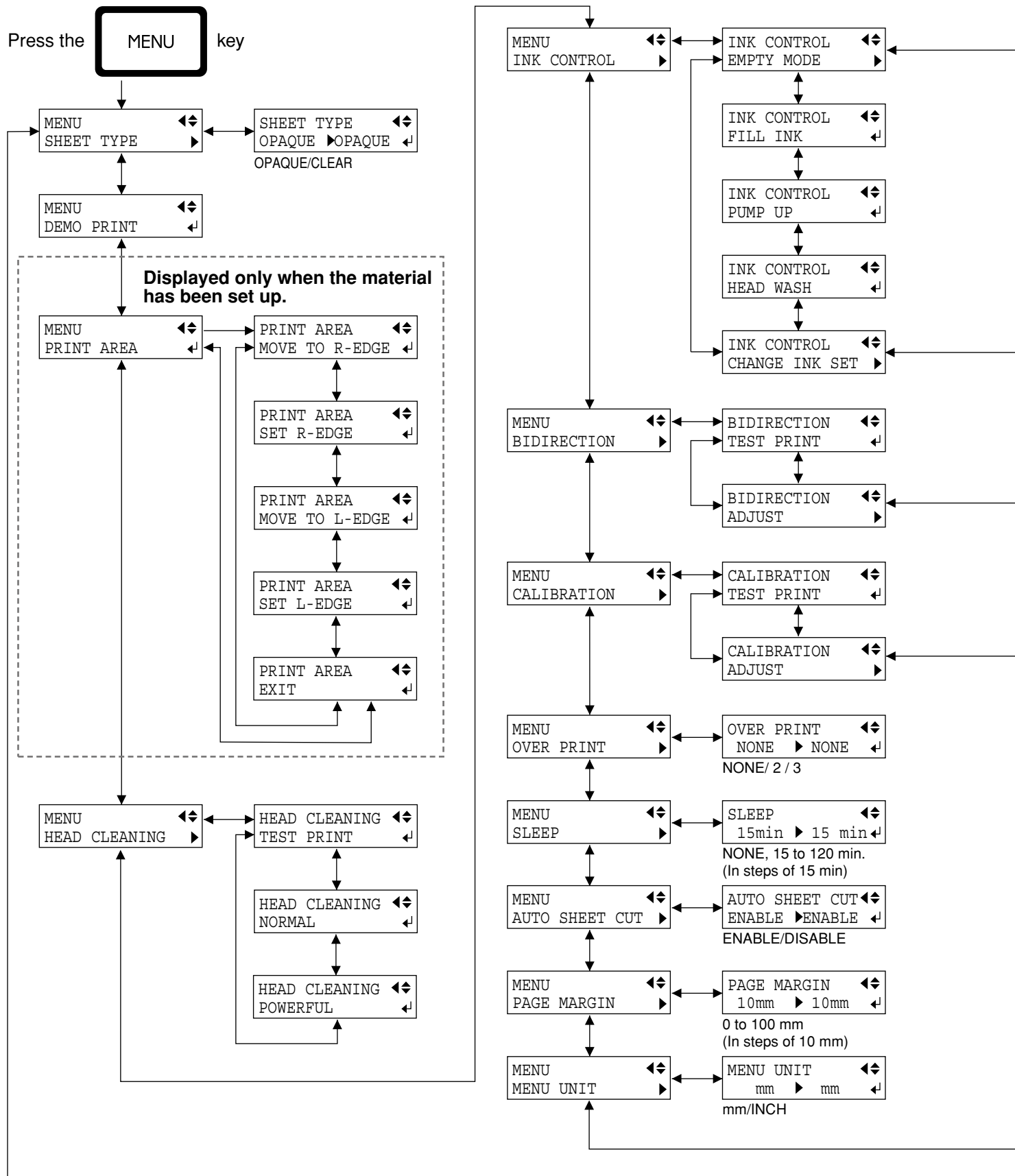

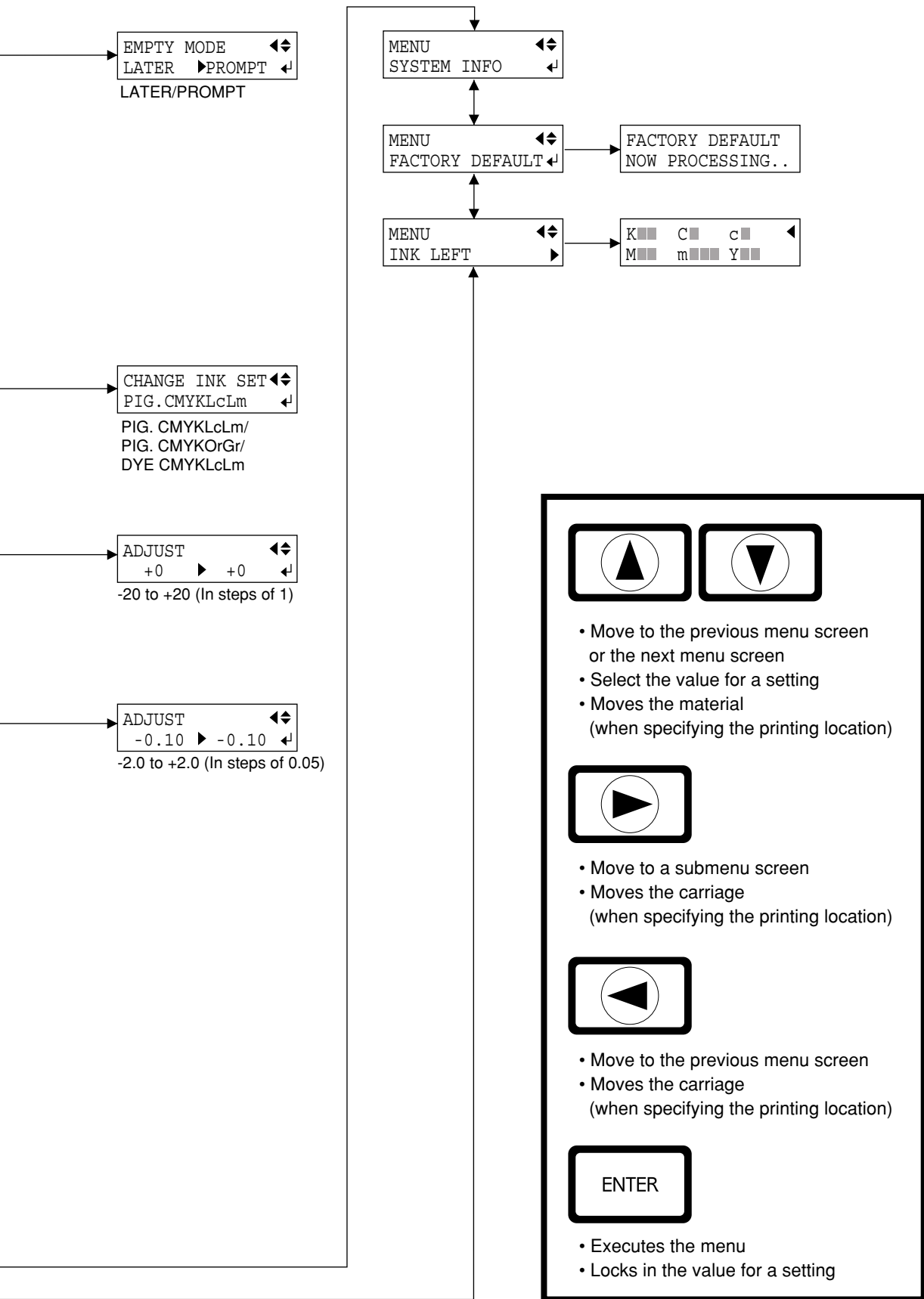









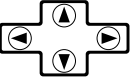

## 4-5 Description of Keys and Display Menus

### Description of Keys

Key	Top menu	Submenu	Function	Setting range	Default value
	—	—	This switches on and off the sub power . When the power is switched on, the POWER LED lights up.	—	—
	—	—	This detects the presence and the width of the material, and displays the printable width. The SETUP LED flashes while detection of material width is in progress. When setup finishes, the SETUP LED lights up continuously. Also press this key when removing the material.	—	—
	—	—	The [PAUSE] key pauses operation. The PAUSE LED lights up while paused. Pressing this key again cancels the paused state. Holding down the [SETUP] key for about 1 second while paused causes remaining data to be cleared and cancels the material's setup state.	—	—
	—	—	This sets the print-start location in the horizontal direction (the direction of carriage movement). For more information, see "2-6 Performing Printing -- Performing Printing at the Desired Location -- Specifying a location in the left-right direction (the direction of carriage movement)."	—	—
	PRINT QUALITY	—	This displays the [PRINT QUALITY] menu for setting image quality. This is used to specify the printing quality and unidirectional or bidirectional printing. Settings cannot be made while printing is in progress. To exit the [PRINT QUALITY] menu screen, press the [MENU] key or the [CLEANING] key or the [SETUP] key. For more information, see "2-6 Performing Printing -- Setting the Printing Mode."	[Printing quality] PHOTO SUPER FINE NORMAL FAST DRAFT  [Printing direction] UNI-DIRECTION BI-DIRECTION	[Printing quality] FINE  [Printing direction] BI-DIRECTION
	HEAD CLEANING	START TEST PRINT	This displays the [HEAD CLEANING] menu for cleaning of the printing head. Before starting to print, you can carry out a printing test to check the printing quality. You can perform cleaning while in any state. Note that [TEST PRINT] is not displayed while the printing is in progress. [TEST PRINT]: Performs a printing test within an area of approximately 54 mm (2-3/16") by 18 mm (6/8"). If there is a problem, then continue by carrying out cleaning from the [START] menu. [START]: Begins cleaning of the printing heads. After cleaning, carry out a printing test to make sure there are no problems. For more information, see "2-5 Test Printing" and "3-3 Cleaning the Printing Heads."	—	—

Key	Top menu	Submenu	Function	Setting range	Default value
	—	—	This severs the material at the present position of the print-start line. Press this to separate the portion that has been printed from the roll. You cannot sever a piece of material while printing is in progress. For more information, see "2-7 Ending Printing Operations -- Separating the Printed Portion."	—	—
	—	—	These move the material and the carriage. When a menu is displayed, these move among the menu items.	—	—
	—	—	This enters the menu mode. When a menu is displayed, the [ ▲ ] and [ ▼ ] keys move to the next menu, the [ ► ] moves to a submenu, and the [ ◀ ] key moves to the previous screen.	—	—
	—	—	This is used to accept, execute, or save the item shown on the display.	—	—
 + 	LANGUAGE	—	This sets the language for screen messages. You can select either English or Japanese.	ENGLISH JAPANESE	ENGLISH

## Description of Menus

Pressing the [MENU] key enters the menu mode.

Top menu	Submenu	Function	Setting range	Default value
SHEET TYPE	—	This is used to select either transparent or opaque material. Select [OPAQUE] when the material loaded on the unit is not transparent. When using transparent material or when the printing area cannot be detected, select [CLEAR]. For more information, see "4-6 What to Do If... -- [INVALID SHEET] appears and the material cannot be detected even when the [SETUP] key is pressed."	OPAQUE CLEAR	OPAQUE
DEMO PRINT	—	This prints a sample image. 	—	—
PRINT AREA	MOVE TO R-EDGE SET R-EDGE MOVE TO L-EDGE SET L-EDGE EXIT	* This appears only when the material is in a loaded state. This sets the printing area in the left-right direction (the direction of carriage movement) of the loaded material. With transparent material, automatic detection of the material width is not performed. In such cases, use the [PRINT AREA] menu to specify the printing area in the left-right direction. Even when using opaque material, this can be used to specify a specific area for performing printing. Pressing the [ENTER] key while [MOVE TO R-EDGE] or [MOVE TO L-EDGE] is displayed moves the carriage to the currently set right- or left-hand edge of the material. When setting a new printing area, make the setting with [SET R-EDGE] or [SET L-EDGE]. For more information, see "2-6 Performing Printing -- Setting the Printing Area." Press [EXIT] to quit this menu.	—	—
HEAD CLEANING	TEST PRINT NORMAL POWERFUL	Before starting to print, you can carry out a printing test to check the printing quality. If the printing test shows a problem, clean the printing head. Because cleaning subjects the head to wear and consumes ink, it should only be performed when absolutely necessary. Performing cleaning from the [POWERFUL] menu in particular subjects the head to early wear and used up large amounts of ink. [TEST PRINT]: Performs a printing test within an area of approximately 54 mm (2-3/16") by 18 mm (6/8"). If a problem is found, then continue by carrying out cleaning. [NORMAL]: Performs cleaning of the printing heads. After cleaning, carry out a printing test to make sure there are no problems with printing quality. You should usually choose [NORMAL]. ([CLEANING] does the same thing as [HEAD CLEANING] - [START] displayed when the [CLEANING] key is pressed.) [POWERFUL]: Used when performing cleaning with [NORMAL] several times does not restore the printing quality. After cleaning, carry out a printing test to make sure there are no problems with printing quality. For more information, see "2-5 Test Printing" and "3-3 Cleaning the Printing Heads."	—	—



## 4 User's Reference

Top menu	Submenu	Function	Setting range	Default value
AUTO SHEET CUT	—	This selects whether the material-cutting command is enabled or disabled. When set to [ENABLED], the material is cut automatically when the computer sends a material-cutting command. For more information, see "2-7 Ending Printing Operations -- Separating the Printed Portion."	ENABLE/ DISABLE	ENABLE
PAGE MARGIN	—	This makes the setting for the margin between pages. When outputting a number of pages continuously, you can establish a margin between the pages. For more information, see "2-9 Other Functions -- Setting the Page Margins."	0 to 100 mm (In steps of 10 mm)	10 mm
MENU UNIT	—	This selects millimeters or inches as the unit of measurement for the width displayed on the top menu after setting up the material. When inch display is used, values are displayed to the first digit to the right of the decimal point.	mm/ INCH	mm
SYSTEM REPORT	—	This prints the current status of settings and other system information.	—	—
FACTORY DEFAULT	—	This returns all menu settings to their original values when shipped from the factory. For more about the factory defaults for the various settings, see the "Default value" entry for each menu setting in this section.	—	—
INK LEFT	—	This shows the amount of ink left after each of the ink cartridges has been installed. The fewer the markers ("■"), the less ink is left. * If a partially used ink cartridge is removed and reinstalled, or if a partially used ink cartridge is installed, the cartridge is taken to be unused, and the displayed amount of remaining ink is not true. For more information, see "3-2 Remaining Ink."	—	—



## 4-6 What to Do If...

### What to Do If...

#### If the FJ-50/40 doesn't run...

Is the power cord connected correctly?

Connect the power cord included with the FJ-50/40 to the unit, and plug the other end securely into an electrical outlet. (See "1-3 Setting Up and Connection".)

Is the FJ-50/40 power on?

Turn on the power. (See "2-3 Powerup".)

Has material been loaded (the SETUP LED is lit)?

If the SETUP LED is not illuminated, make sure the material is loaded correctly and press the [SETUP] key to illuminate the SETUP LED.

Is the PAUSE LED illuminated?

If the [PAUSE] key has been pressed and the PAUSE LED is lighted, the unit has been paused.

To resume printing or cutting, press the [PAUSE] key again. The PAUSE LED is extinguished, and printing or cutting resumes.

To terminate printing or cutting, first stop the transmission of printing or cutting instructions from the computer to the FJ-50/40. Then press the [SETUP] key. Hold down for about 1 second. This deletes the printing or cutting instructions that have already been sent from the computer to the FJ-50/40, and printing or cutting is stopped.

Is the top menu displayed?

If the top menu isn't displayed, printing doesn't start even when data is sent from the computer.

Conditions for starting printing

The material must be already set up (with the SETUP LED lighted), and the display must show the top menu.

If another menu screen is displayed, press the [SETUP] key to go back to the top menu.

(Pressing the [SETUP] key when another menu screen is displayed does not cancel the set-up for the material.)

#### Top menu

W 1234 mm
FINE BI-DIR

Are the computer and the FJ-50/40 linked with the right cable ?

The type of cable you need is determined by your computer. One which you are sure matches the model of computer being used should be select.

Is the cable making a secure connection?

Connect securely. (See "1-3 Setting Up and Connection".)

Has the correct driver selection been made for the application software?

Select the appropriate FJ-50/40 driver.

## [INVALID SHEET] appears and the material cannot be detected even when the [SETUP] key is pressed

If the material loaded on the unit is transparent, then at the [SHEET TYPE] menu, select [CLEAR].

- 1** Press the [MENU] key and [▼] key to make the following screen appear on the display.

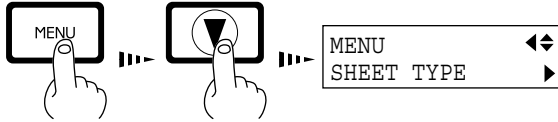

- 2** Press the [▶] key to make the following screen appear on the display.



- 3** Use the [▼] key to select [CLEAR], then press the [ENTER] key.

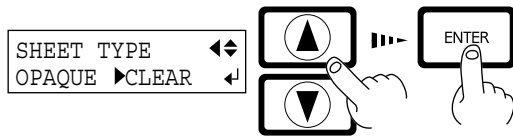

- 4** Specify a printing area for the left-right direction (the direction of carriage movement) that matches the width of the material. For more information, see " 2-6 Performing Printing -- Performing Printing at the Desired Location -- Setting the printing area in the left-right direction (the direction of carriage movement)."



When [SHEET TYPE] has been set to [CLEAR], no detection of the material is performed when material is loaded. This means it is necessary to specify a printing area that matches the actual width of the material.

When only set to [CLEAR], the printable width is set to the maximum (FJ-50: 1322 mm (52"), FJ-40: 1066 mm (42")).

- When the setting for [SHEET TYPE] is changed after setup for the material has been performed, the setup for the material is automatically canceled. If this happens, set up the material again.
- When using opaque material, return the [SHEET TYPE] setting to [OPAQUE].

## If the "INK EMPTY" message appears during setup

A cartridge has run out of ink, and printing cannot be started.

If printing data is being sent, this message is displayed and the buzzer sounds. At the same time, operation is paused and the PAUSE LED flashes. Replace the empty cartridge with a new one and press the [PAUSE] key to start printing.

## Clean, attractive printing is impossible

If drop-out occurs with printed images.

Clean the printing heads (see "3-3 Cleaning the Printing Heads").

Is the surface of the platen dirty or scratched?

Clean the platen (see "3-6 Cleaning").

Is the material dirty?

Remove superficial soiling, then load the material.

Is the material damaged?

Clean, attractive printing is not possible if the material is damaged or warped.

Use care to keep materials from being damaged while in storage.

During printing, was the front cover opened (executing an emergency stop) or the [PAUSE] key pressed?

If operation is stopped or paused while printing is in progress, the quality of the image before and after the interruption may differ. It is a good idea to avoid pausing operation while printing is in progress whenever possible.

Is thick material in use, or does the surface of the material rub against the printing heads?

If material feed is not smooth because the material catches on the head, then adjust the height of the printing heads (see "4-2 Adjusting the Height of the Printing Head").

When the height of the printing head has been adjusted, it is necessary to perform bidirectional correction (only when the printing direction for [PRINT QUALITY] has been set to [BI-DIRECTION]). For more information about bidirectional correction, see "2-6 Performing Printing - Making Corrections for Printing - Bidirectional Correction."

If the type of material was changed, was feed correction performed?

Correcting the amount of feed improves the dot-positioning accuracy in the feed direction, which can help enhance image quality.

If the type of material was changed, refer to "2-6 Printing - Making Corrections for Printing - Feed Correction" and perform correction for feed.

## Printing goes beyond the loaded material

Is [SHEET TYPE] set to [CLEAR]?

When [SHEET TYPE] has been set to [CLEAR], no detection of the material width is performed when material is loaded (printable width set to maximum).

If transparent material has been loaded, specify a printing area that matches the actual material width (see "2-6 Performing Printing -- Performing Printing at the Desired Location -- Setting the printing area in the left-right direction (the direction of carriage movement)").

If opaque material has been loaded, set [SHEET TYPE] to [OPAQUE].

Is the reflective tape dirty?

If the reflective tape becomes soiled, the width of the material cannot be detected correctly.

If the tape becomes dirty, wipe gently with a cloth moistened with water or ethyl alcohol.

Has the material been loaded at an angle?

If the loaded material is not straight, it may extend outside the printing area.

Refer to "2-5 Loading the Material" and load the material correctly.

Has the printing area been set to fill the material entirely?

When setting the printing area in the left-right direction (the direction of carriage movement) at the [PRINT AREA] menu, leave a margin on either side. If the printing area is set to extend all the way to the left right and right edges, a small amount of misalignment may result in printing beyond the edge of the material.

### Material feed is not smooth (slippage occurs)

#### Is thick material being used?

If the surface of the material rubs against the printing heads and smooth feed is impossible, then adjust the height of the printing heads (see "4-2 Adjusting the Height of the Printing Head").

When the height of the printing head has been adjusted, it is necessary to perform bidirectional correction (only when the printing direction for [PRINT QUALITY] has been set to [BI-DIRECTION]). For more information about bidirectional correction, see "2-6 Performing Printing - Making Corrections for Printing - Bidirectional Correction."

#### If using sheet material, does the loaded material contact areas such as the stand's media flange?

If the sheet material contacts the media flange or the like at the back of the unit, shift the retainer to a location where the material doesn't make contact.

If the material touches an obstruction while printing is in progress, normal material feed is not performed, and image quality may suffer or the material may jam.

#### Is the sheet material loaded at an angle? Are the left and right edges of the material not straight?

If the material is loaded at an angle or if the left and right sides of the material are not cut straight, the location of the edges may shift as feed is carried out. This may cause the material to rub against the inner side of the FJ-50/40 or be displaced from the printing area.

#### Is the roll material loaded correctly?

If the roll material is not loaded correctly, the material may come loose or advance at an angle. Refer to "2-4 Loading the Material" and load the material correctly.

### The material becomes jammed

If [MOTOR ERROR : TURN OFF POWER] appears and operation stops

- (1) Press the [POWER] key to switch off the sub power.
  - (2) Remove the jammed material. Cut off any creased or torn portions.
  - (3) Press the [POWER] key to turn on the sub power.
  - (4) Correct whatever caused the material to jam.  
(For example, if thick material has been loaded, then adjust the height of the printing heads.)
  - (5) Load the material and carry out setup.
  - (6) Press the [CLEANING] key to perform head cleaning and a printing test (see "3-3 Cleaning the Printing Heads").
  - (7) Send the printing data and perform printing.
- \* Jammed material may damage or soil the printing heads. Be sure to perform head cleaning first before sending the printing data.

When printing was continued, but should be started over

- (1) Press the [PAUSE] key to pause operation.
  - (2) Stop sending data from the computer.
  - (3) Press the [SETUP] key. Hold down for about 1 second (making the SETUP LED go dark).
  - (4) Press the [POWER] key to switch off the sub power.
  - (5) Remove the jammed material. Cut off any creased or torn portions.
  - (6) Press the [POWER] key to turn on the sub power.
  - (7) Correct whatever caused the material to jam.  
(For example, if thick material has been loaded, then adjust the height of the printing heads.)
  - (8) Load the material and carry out setup.
  - (9) Press the [CLEANING] key to perform head cleaning and a printing test (see "3-3 Cleaning the Printing Heads").
  - (10) Send the printing data and perform printing.
- \* Jammed material may damage or soil the printing heads. Be sure to perform head cleaning first before sending the printing data.

## Printed lines are misaligned

### [Example]

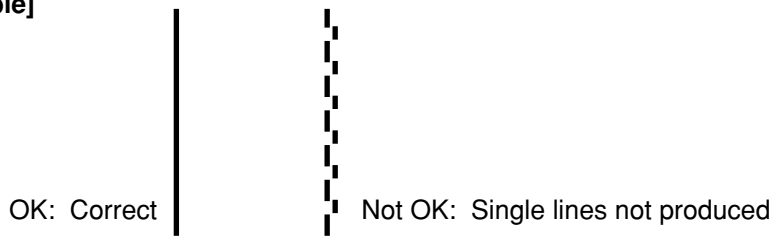

If misalignment like in the example occurs when the printing direction for [PRINT QUALITY] has been set to [BI-DIRECTION] (bidirectional), then carry out correction at the [BIDIRECTION] menu (see "2-6 Performing Printing - Making Corrections for Printing - Bidirectional Correction").

Be sure to make this adjustment when you have replaced the material with a different type or adjusted the head height.

## The material cannot be separated

Is a blade installed in the separating knife?

If no blade is installed, then install one (see "3-5 How to Replace the Separating Knife").

Is the blade dull or broken?

If the blade has become dull or broken, replace it with the replacement blade included with the unit (see "3-5 How to Replace the Separating Knife").

\* Some materials cannot be separated due to their composition.

## The material cannot be separated automatically

Has the [AUTO SHEET CUT] menu item been set to [ENABLE]?

If the material-cutting command has been set to "enable" with the driver, then set [AUTO SHEET CUT] on the FJ-50/40 to [ENABLE] (see "2-7 Ending Printing Operations -- Separating the Printed Portion").

Has the material-cutting command been set to "enable" with the driver?

When the material-cutting command has not been set to "enable" with the driver, automatic separation of the material is not performed, even when [AUTO SHEET CUT] has been set to [ENABLE].

# Messages

Messages	Meaning	Action
CLOSE THE COVER	An operation command was given while the cover is open.	Close the cover.
SHEET UNLOADED	Test printing was attempted with no material loaded.	Load the material and try again. Press the [ENTER] key to continue.
INK EMPTY [KCMcmY] *	Ink has been used up.	Replace the empty ink cartridge.
SET CARTRIDGE [KCMcmY] *	An ink cartridge was removed. A request to insert an ink cartridge was made from the FJ-50/40.	Insert the specified ink cartridge.
REMOVE CARTRIDGE [KCMcmY] *	A request to remove an ink cartridge was made from the FJ-50/40.	Take out the specified ink cartridge.
SET CL-LIQUID [KCMcmY] *	A request to insert a cleaning cartridge was made from the FJ-50/40.	Insert the specified cleaning cartridge.
REMOVE CL-LIQUID [KCMcmY] *	A request to remove a cleaning cartridge was made from the FJ-50/40.	Take out the specified cleaning cartridge.
DISCARD DRAIN INK	Check that the drain bottle is set in position when filling ink. * This message appears before operations that will discharge large amounts of ink. There is a chance of discharged ink overflowing if operations are carried out while the drain bottle is full. As a guide, you should discard discharged ink when the bottle is about half-full.	Remove the drain bottle from the FJ-50/40, discard the collected ink, then reinstall the drain bottle. Press the [ENTER] key to continue.
INSTALL DRAIN TANK	Check that the drain bottle is set in position when filling ink.	Set the drain bottle in place.
TO CANCEL, PRESS SETUP KEY	Operation was paused by pressing the [PAUSE] key, but there is still some remaining data.	Pressing the [PAUSE] key again to resume operation. Pressing the [SETUP] key while paused causes remaining data to be cleared and returns to the NOT READY mode.
TO CONTINUE, PRESS ENTER KEY	To continue, press the [ENTER] key.	Press the [ENTER] key.
DRY-UP OF HEAD MAY GIVE DAMAGE	Emergency stop was effected. * "CLOSE THE COVER" is also displayed repeatedly. Audible alert each 10 sec. After 1 min., audible alert goes continuously.	Close the cover. * When restarting print, such detect like raster line or shift of band may happen.

\* [KCMcmY] : This indicates the ink color. The character indicating the color of the ink cartridge port flashes when operation is necessary.

K = Black C = Cyan M = Magenta c = Light Cyan (O = Orange) m = Light Magenta (G = Green) Y = Yellow

[Example]

INK EMPTY [KCMcmY]
-----------------------

If "K" and "c" are flashing  
Black and Light Cyan inks have run out.

## Error Messages

Error messages	Meaning	Action
MOTOR ERROR TURN OFF POWER	A motor error occurred.	Recovery from this problem is impossible. Use the POWER key to switch the power off and back on again. After rectifying the cause of the error (a material jam or the like), switch on the power. Do not leave the unit with the carriage not in standby position.
TEMPERATURE IS TOO LOW	The air temperature where installed is lower than the ambient temperature at which the unit can operate (approx. 5°C (41°F) or more lower).	Recovery from this problem is impossible. Use the [POWER] key to switch the power off. First raise the temperature of the area where installed, then switch on the power.
INVALID SHEET SET SHEET AGAIN	The [SETUP] key was pressed even though no material is loaded. Setup was performed with no material at the correct location.  [Sheet Type] is set to [OPAQUE], but transparent material was loaded.	Load material at the correct location and press the [SETUP] key again.  When using transparent material, set [SHEET TYPE] to [CLEAR] (see "4-6 What to Do If... (If the "INK EMPTY" message appears during setup)").
SHEET TOO SMALL SET SHEET AGAIN	An attempt was made to load material that is too small.  The reflective tape is dirty.	Replace with material of loadable size.  Wipe off the grime on the reflective tape, then perform setup again.
PINCHROLL ERROR DOWN PINCHROLL	The [SETUP] key was pressed with the pinch rollers up. The pinch rollers were raised during setup.	Move the sheet loading levers toward "LOAD" and lower the pinch rollers, then press the [SETUP] key (see "2-4 Loading the Material").
BASE POINT ERROR	An attempt was made to set the print-start location at a position beyond the material.	Use the arrow keys to move the carriage marker to a place within the printing area, then press the [BASE POINT] key (see "2-6 Performing Printing -- Performing Printing at the Desired Location").
PRINT R-EDGE SET ERROR	The setting for the right-hand edge was not made correctly at the [PRINT AREA] menu. An attempt was made to set the right-hand edge to the left of the left-hand edge, or at the same location as the left-hand edge.	Use the arrow keys to move the carriage marker to a correct position, then make the setting (see "2-6 Performing Printing -- Performing Printing at the Desired Location -- Setting the printing area in the left-right direction (the direction of carriage movement)").
PRINT L-EDGE SET ERROR	The setting for the left-hand edge was not made correctly at the [PRINT AREA] menu. An attempt was made to set the left-hand edge to the right of the right-hand edge, or at the same location as the right-hand edge.	Use the arrow keys to move the carriage marker to a correct position, then make the setting (see "2-6 Performing Printing -- Performing Printing at the Desired Location -- Setting the printing area in the left-right direction (the direction of carriage movement)").
HEAD DRY-UP WARNING	The printing head was returned to its standby position to be capped, canceling current printing job. Because emergency stop was effected more than 10 min.	Turn power off by pressing [POWER] key to reset.

## 4-7 Specifications

		FJ-50	FJ-40
Printing method		Piezo ink-jet method	
Printing width		210 mm — 1320 mm (8-5/16" — 52")	210 mm — 1066 mm (8-5/16" — 42")
Acceptable material widths		210 mm — 1350 mm (8-5/16" — 53-1/8")	210 mm — 1125 mm (8-5/16" — 44-1/4")
Width of material that can be cut off		210 mm — 1350 mm (8-5/16" — 53-1/8")	210 mm — 1125 mm (8-5/16" — 44-1/4")
Conditions for usable materials		Maximum material thickness: 1.0 mm (0.039") (When head is raised) Maximum diameter for roll material: 180 mm (7-1/16") Core inner diameter for roll material: 50.8 mm (2") or 76.2 mm (3") Maximum weight for roll material: 20 kg (44.1 lb.)	
Ink cartridges	Pigment ink	Use only pigment ink cartridge exclusively for use with the Hi-Fi JET	
	Capacity	220 cc ±5 cc	
	Color	Six colors: the four colors cyan, magenta, yellow, and black, plus either light cyan and light magenta or orange and green	
	Dye ink	Use only dye ink cartridge exclusively for use with the Hi-Fi JET	
	Capacity	220 cc ±5 cc	
	Color	Cyan, magenta, yellow, black, light cyan, and light magenta	
Apparent colors		16.7 million colors	
Printing resolution (Printing dot resolution)		1440 dpi x 720 dpi / 720 dpi x 720 dpi / 360 dpi x 720 dpi / 180 dpi x 720 dpi	
Distance accuracy		Error of less than ±0.3% of distance traveled, or 0.3 mm, whichever is greater (at Roland PET-film, print travel: 1 m (39-3/8"))	
Printing heads cleaning		Automatic cleaning and manual cleaning	
Interface		Bidirectional parallel interface (compliant with IEEE 1284: nibble mode)	
Instruction system		RD-RTL, RD-PJL	
Power-saving function		Auto-sleep	
Power consumption	Printing mode	Maximum: 0.7A/100V—240V ±10% 50/60 Hz	
	Standby mode	Maximum: 0.3A/100V—240V ±10% 50/60 Hz	
Acoustic noise level	Printing mode	60dB (A) or less (According to ISO7779)	
	Standby mode	40dB (A) or less	
Dimensions	Main unit	2247 mm [W] x 381 mm [D] x 392 mm [H] (88-1/2" [W] x 15" [D] x 15-7/16" [H])	2022 mm [W] x 381 mm [D] x 392 mm [H] (79-5/8" [W] x 15" [D] x 15-7/16" [H])
	With stand	2247 mm [W] x 736 mm [D] x 1251 mm [H] (88-1/2" [W] x 29" [D] x 49-5/16" [H])	2022 mm [W] x 736 mm [D] x 1251 mm [H] (79-5/8" [W] x 29" [D] x 49-5/16" [H])
Weight	Main unit	75 kg (165.3 lb.)	69 kg (152.1 lb.)
	With stand	90.5 kg (199.5 lb.)	84 kg (185.2 lb.)
Environment	Power on	Temperature: 15°C to 35°C (59°F to 95°F), Humidity: 35% to 80% (non-condensing)	
	Power off	Temperature: 5°C to 40°C (41°F to 104°F), Humidity: 20% to 80% (non-condensing)	
Accessories		Power cord: 1, Drain-bottle cap: 1, Screws: 2, Drain bottle: 1, Replacement blade for separating knife: 1, Roland COLORCHOICE® CD-ROM: 1, User's manual: 1, Roland COLORCHOICE® installation guide: 1, Cleaning kit: 1	



## Interface Specifications

Standard	Bidirectional parallel interface (compliant with IEEE 1284: nibble mode)
Input signals	$\overline{\text{STROBE}}$ (1BIT), DATA (8BITS), $\overline{\text{SLCT IN}}$ , $\overline{\text{AUTO FEED}}$ , $\overline{\text{INIT}}$
Output signals	BUSY (1BIT), $\overline{\text{ACK}}$ (1BIT), $\overline{\text{FAULT}}$ , SLCT, PERROR
Level of input output signals	TTL level
Transmission method	Asynchronous

### Parallel Connector (in compliance with specifications of Centronics)

Signal number	Terminal number		Signal number
$\overline{\text{SLCT IN}}$	36	18	HIGH***
HIGH*	35	17	GND
NC	34	16	GND
GND	33	15	NC
$\overline{\text{FAULT}}$	32	14	$\overline{\text{AUTO FEED}}$
$\overline{\text{INIT}}$	31	13	SLCT
GND	30	12	PERROR
	29	11	BUSY
	28	10	$\overline{\text{ACK}}$
	27	9	D7
	26	8	D6
	25	7	D5
	24	6	D4
	23	5	D3
	22	4	D2
	21	3	D1
	20	2	D0
	19	1	$\overline{\text{STROBE}}$

#### Pin Connection

