

MODELA
MDX-40A
User's Manual

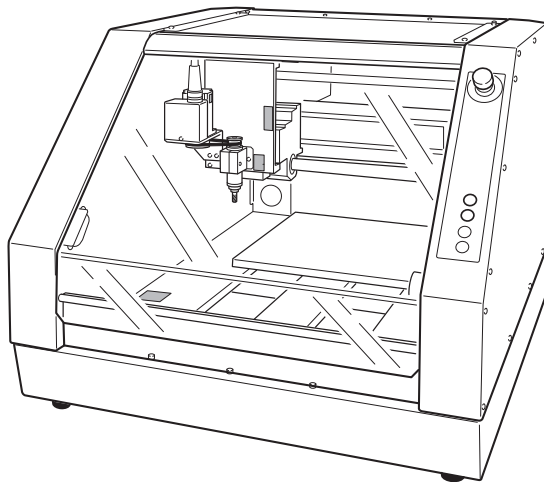

Thank you very much for purchasing this product.

- To ensure correct and safe usage with a full understanding of this product's performance, please be sure to read through this manual completely and store it in a safe location.
- Unauthorized copying or transferral, in whole or in part, of this manual is prohibited.
- The contents of this operation manual and the specifications of this product are subject to change without notice.
- The operation manual and the product have been prepared and tested as much as possible. If you find any misprint or error, please inform us.
- Roland DG Corp. assumes no responsibility for any direct or indirect loss or damage which may occur through use of this product, regardless of any failure to perform on the part of this product.
- Roland DG Corp. assumes no responsibility for any direct or indirect loss or damage which may occur with respect to any article made using this product.

Roland DG Corporation

For the USA

FEDERAL COMMUNICATIONS COMMISSION RADIO FREQUENCY INTERFERENCE STATEMENT

This equipment has been tested and found to comply with the limits for a Class A digital device, pursuant to Part 15 of the FCC Rules.

These limits are designed to provide reasonable protection against harmful interference when the equipment is operated in a commercial environment.

This equipment generates, uses, and can radiate radio frequency energy and, if not installed and used in accordance with the instruction manual, may cause harmful interference to radio communications.

Operation of this equipment in a residential area is likely to cause harmful interference in which case the user will be required to correct the interference at his

own expense.

Unauthorized changes or modification to this system

can void the users authority to operate this equipment. When the equipment requires a usb cable, it must be shielded type.

For Canada

CLASS A NOTICE

This Class A digital apparatus meets all requirements of the Canadian Interference-Causing Equipment Regulations.

CLASSE A AVIS

Cet appareil numérique de la classe A respecte toutes les exigences du Règlement sur le matériel brouilleur du Canada.

NOTICE

Grounding Instructions

In the event of a malfunction or breakdown, grounding provides a path of least resistance for electric current to reduce the risk of electric shock. This tool is equipped with an electric cord having an equipment-grounding conductor and a grounding plug. The plug must be plugged into a matching outlet that is properly installed and grounded in accordance with all local codes and ordinances.

Do not modify the plug provided - if it will not fit the outlet, have the proper outlet installed by a qualified electrician.

Improper connection of the equipment-grounding conductor can result in a risk of electric shock. The conductor with insulation having an outer surface that is green with or without yellow stripes is the equipment-grounding conductor. If repair or replacement of the electric cord or plug is necessary, do not connect the equipment-grounding conductor to a live terminal.

Check with a qualified electrician or service personnel if the grounding instructions are not completely understood, or if in doubt as to whether the tool is properly grounded.

Use only 3-wire extension cords that have 3-prong grounding plugs and 3-pole receptacles that accept the tool's plug.

Repair or replace damaged or worn cord immediately.

For California

WARNING

This product contains chemicals known to cause cancer, birth defects and other reproductive harm, including lead.

For EU Countries



Manufacturer:

ROLAND DG CORPORATION

1-6-4 Shinmiyakoda, Kita-ku, Hamamatsu-shi, Shizuoka-ken, 431-2103 JAPAN

The authorized representative in the EU:

Roland DG Corporation, German Office Halskestr. 7, 47877 Willich, Germany

For EU Countries

WARNING

This is a Class A product. In a domestic environment this product may cause radio interference in which case the user may be required to take adequate measures.

Roland DG Corp. has licensed the MMP technology from the TPL Group.

Operating Instructions

KEEP GUARDS IN PLACE and in working order.

REMOVE ADJUSTING KEYS AND WRENCHES. Form habit of checking to see that keys and adjusting wrenches are removed from tool before turning it on.

KEEP WORK AREA CLEAN. Cluttered areas and benches invite accidents.

DON'T USE IN DANGEROUS ENVIRONMENT. Don't use power tools in damp or wet locations, or expose them to rain. Keep work area well lighted.

KEEP CHILDREN AWAY. All visitors should be kept safe distance from work area.

MAKE WORKSHOP KID PROOF with padlocks, master switches, or by removing starter keys.

DON'T FORCE TOOL. It will do the job better and safer at the rate for which it was designed.

USE RIGHT TOOL. Don't force tool or attachment to do a job for which it was not designed.

USE PROPER EXTENSION CORD. Make sure your extension cord is in good condition. When using an extension cord, be sure to use one heavy enough to carry the current your product will draw. An undersized cord will cause a drop in line voltage resulting in loss of power and overheating.

WEAR PROPER APPAREL. Do not wear loose clothing, gloves, neckties, rings, bracelets, or other jewelry which may get caught in moving parts. Nonslip footwear is recommended. Wear protective hair covering to contain long hair.

USE SAFETY GLASSES, face or dust mask if cutting or cleaning operation is dusty. Everyday eyeglasses only have impact resistant lenses, they are NOT safety glasses.

SECURE WORK. Use clamps or a vise to hold work when practical.

DON'T OVERREACH. Keep proper footing and balance at all times.

MAINTAIN TOOLS WITH CARE. Keep tools sharp and clean for best and safest performance. Follow instructions for lubricating and changing accessories.

DISCONNECT TOOLS before servicing; when changing accessories, such as blades, bits, cutters, and the like.

REDUCE THE RISK OF UNINTENTIONAL STARTING. Make sure switch is in off position before plugging in.

USE RECOMMENDED ACCESSORIES. Consult the owner's manual for recommended accessories. The use of improper accessories may cause risk of injury to persons.



NEVER STAND ON TOOL. Serious injury could occur if the tool is tipped or if the cutting tool is unintentionally contacted.

CHECK DAMAGED PARTS. Before further use of the tool, a guard or other part that is damaged should be carefully checked to determine that it will operate properly and perform its intended function - check for alignment of moving parts, binding of moving parts, breakage of parts, mounting, and any other conditions that may affect its operation. A guard or other part that is damaged should be properly repaired or replaced.

NEVER LEAVE TOOL RUNNING UNATTENDED. TURN POWER OFF. Don't leave tool until it comes to a complete stop.

USE POWER SUPPLY CORD WHICH IS ATTACHED WITH PRODUCTS. Do not use other power supply cord.

Contents

 To Ensure Safe Use	6
 Pour utiliser en toute sécurité	13
Important Notes on Handling and Use.....	20
About the Documentation for This Machine	21
Documentation Included with the Machine	21
Installing the NC Code Reference MANUAL.....	21
Viewing the NC Code Reference MANUAL	22
Chapter 1 Getting Started	23
1-1 Machine Highlights.....	24
Overview of the Unit.....	24
Operating the Machine.....	24
1-2 Part Names and Functions	25
Front.....	25
Side.....	26
VPanel.....	27
Built-in Panel	28
Chapter 2 Installation and Setup	29
2-1 Checking the Included Items.....	30
2-2 Installation.....	31
Installation Environment.....	31
Installation Environment.....	31
Removing and Storing the Retainers.....	33
2-3 Cable Connections.....	34
Connecting the Power Cord.....	34
Connecting to the Computer.....	35
2-4 Installing and Setting Up the Software	36
System Requirements.....	36
The Software You Can Install and Set Up.....	37
Installing the Windows-based Driver	38
Installing VPanel and Other Softwares	39
Viewing the Documentation for the Softwares.....	40
Chapter 3 Basic Operation.....	41
3-1 Types of Emergency Stops to Ensure Safety.....	42
How to Perform an Emergency Stop.....	42
To Cancel an Emergency Stop	42
Emergency Stop Due to Opening or Closing the Front Cover.....	42
3-2 Starting and Quitting	43
How to Start the Machine	43
Shutdown.....	45

- 3-3 Selecting the Command Set46
 - What is Command Set?46
 - Selecting Command Set46
- 3-4 Moving the Tool48
 - Manual Feed.....48
 - About the Displayed Tool Position49
 - Moving to a Specific Position51
 - Moving to the VIEW Position.....51
- 3-5 Starting and Stopping Spindle Rotation52
 - Starting or Stopping the Spindle.....52
- 3-6 Pausing/Resuming/Quitting of Cutting53
 - Pausing and Resuming of Cutting by Operation of the Machine53
 - Quitting Cutting by Operation of the Machine54
 - Quitting Cutting by Operating from the VPanel55
- Chapter 4 Getting Ready for and Performing Cutting57**
 - 4-1 Cutting Area58
 - Workpiece Size and Location Where Secured in Place58
 - Actual Size That Can Be Cut58
 - 4-2 Installing a Tool59
 - Tool Selection59
 - Features of the Tools.....59
 - Installing a Tool (End mill)59
 - 4-3 Starting Cutting61
 - About Origin Point.....61
 - Setting Origin Point.....61
 - Start Cutting (Output to the machine directly form the application)64
 - Start Cutting (Output via VPanel)65
 - Recovery of Operation from Emergency Stop or Emergency Shutdown67
 - 4-4 Override68
 - What's an Override?.....68
 - How to Make the Settings for Overrides.....68
- Chapter 5 Appendix69**
 - 5-1 Using the Z0 Sensor70
 - What's a Z0 Sensor70
 - Setting the Z Origin Using the Z0 Sensor70
 - Setting the Thickness of the Z0 Sensor72
 - 5-2 Using the Engraving Cutter73
 - Installing the Engraving Cutter and Setting the Origin Point73
 - 5-3 Maintenance76
 - Cleaning.....76
 - Maintenance of the Spindle Unit.....77
 - 5-4 What to Do If...78
 - The Power Does Not Come On.....78
 - Initialization is Not Performed or Initialization Fails.78
 - VPanel Doesn't Start Correctly.....78

Operations are Ignored.....	78
The Spindle Doesn't Rotate.....	79
Abnormal Cutting is Performed.....	79
The Origin is Misaligned.....	79
The Feed Rate or Spindle Speed is Wrong.....	79
The Cutting Results are Not Attractive.....	79
What to Do If a Flashing Error Is Displayed.....	80
Installation is Impossible.....	80
Uninstalling the Driver.....	81
5-5 Responding to an Error Message.....	83
For Connection of Equipment.....	83
Detection Failure.....	83
Pause.....	83
Emergency Stop.....	84
5-6 Power Rating and Serial Number Locations.....	86
5-7 NC Code Specifications.....	87
Settings for NC Codes.....	87
Items Related to the Mechanical Specifications.....	87
Interpretation of Omitted NC Codes.....	88
Word List.....	89
5-8 Specifications.....	91
Expansion Connector.....	91
External View.....	92
Dimensional Drawings of the Table Area.....	93
Main Specifications.....	94
System Requirements for USB Connection.....	95



Company names and product names are trademarks or registered trademarks of their respective holders.





To Ensure Safe Use

Improper handling or operation of this machine may result in injury or damage to property. Points which must be observed to prevent such injury or damage are described as follows.

About WARNING and CAUTION Notices

 WARNING	Used for instructions intended to alert the user to the risk of death or severe injury should the unit be used improperly.
 CAUTION	Used for instructions intended to alert the user to the risk of injury or material damage should the unit be used improperly. Note: Material damage refers to damage or other adverse effects caused with respect to the home and all its furnishings, as well to domestic animals or pets.

About the Symbols

	The  symbol alerts the user to important instructions or warnings. The specific meaning of the symbol is determined by the design contained within the triangle. The symbol at left means "danger of electrocution."
	The  symbol alerts the user to items that must never be carried out (are forbidden). The specific thing that must not be done is indicated by the design contained within the circle. The symbol at left means the unit must never be disassembled.
	The  symbol alerts the user to things that must be carried out. The specific thing that must be done is indicated by the design contained within the circle. The symbol at left means the power-cord plug must be unplugged from the outlet.

 **Incorrect operation may cause injury.**

 **WARNING**

 **Be sure to follow the operation procedures described in this documentation. Never allow anyone unfamiliar with the usage or handling of the machine to touch it.**

Incorrect usage or handling may lead to an accident.

 **Keep children away from the machine.**

The machine includes areas and components that pose a hazard to children and may result in injury, blindness, choking, or other serious accident.

 **Never operate the machine while tired or after ingesting alcohol or any medication.**

Operation requires unimpaired judgment. Impaired judgment may result in an accident.

 **Conduct operations in a clean, brightly lit location.**

Working in a location that is dark or cluttered may lead to an accident, such as becoming caught in the machine as the result of an inadvertent stumble.

 **Never use the machine for any purpose for which it is not intended, or use the machine in an undue manner that exceeds its capacity.**

Doing so may result in injury or fire.

 **Never use a cutting tool that has become dull. Perform frequent maintenance to keep and use the machine in good working order.**

Unreasonable usage may result in fire or injury.

 **WARNING**

 **For accessories (optional and consumable items, power cord, and the like), use only genuine articles compatible with this machine.**

Incompatible items may lead to an accident.

 **Before attempting cleaning, maintenance, or attachment or detachment of optional items, disconnect the power cord.**

Attempting such operations while the machine is connected to a power source may result in injury or electrical shock.

 **Never attempt to disassemble, repair, or modify the machine.**

Doing so may result in fire, electrical shock, or injury. Entrust repairs to a trained service technician.

 **CAUTION**

 **Never climb or lean on the machine.**

The machine is not made to support a person. Climbing or leaning on the machine may dislodge components and cause a slip or fall, resulting in injury.

 **Never operate if a front cover is cracked or broken.**

Doing so may result in injury. If the front cover is cracked, contact your authorized Roland DG Corp. dealer.

 **This machine weighs 65 kg (144 lb.)**

 **CAUTION**



Unloading and emplacement are operations that must be performed by 4 persons or more.

Tasks that require undue effort when performed by a small number of persons may result in physical injury. Also, if dropped, such items may cause injury.



Install in a location that is level and stable.

Installation in an unsuitable location may cause an accident, including a fall or tipover.

 **The cutting waste or workpiece may catch fire or pose a health hazard.**

 **WARNING**



Never attempt to cut magnesium or any other such flammable material.
Fire may occur during cutting.



Keep open flame away from the work area.
Cutting waste may ignite. Powdered material is extremely flammable, and even metal material may catch fire.



When using a vacuum cleaner to take up cutting waste, exercise caution to prevent fire or dust explosion.

Taking up fine cuttings using an ordinary vacuum cleaner may cause danger of fire or explosion. Check with the manufacturer of the vacuum cleaner. When the safety of use cannot be determined, clean using a brush or the like, without using the vacuum cleaner.

 **CAUTION**





Wear dust goggles and a mask. Wash away any cutting waste remaining on the hands.

Accidentally swallowing or inhaling cutting waste may be hazardous to the health.

 **Danger of pinching, entanglement, and burns.**

 **WARNING**

 **Never attempt operation while wearing a necktie, necklace, loose clothing, or gloves. Bind long hair securely.**
Such items may become caught in the machine, resulting in injury.

 **Securely fasten the cutting tool and workpiece in place. After securing in place, make sure no wrenches or other articles have inadvertently been left behind.**
Otherwise such articles may be thrown from the machine with force, posing a risk of injury.

 **WARNING**

 **Exercise caution to avoid being pinched or becoming caught.**
Inadvertent contact with certain areas may cause the hand or fingers to be pinched or become caught. Use care when performing operations.

 **Caution: cutting tool.**
The cutting tool is sharp. To avoid injury, exercise caution.

 **Caution: high temperatures.**
The cutting tool and spindle motor become hot. Exercise caution to avoid fire or burns.

 **Danger of electrical short, shock, electrocution, or fire**

 **WARNING**

 **Do not use with any electrical power supply that does not meet the ratings displayed on the unit.**
Use with any other power supply may lead to fire or electrocution.

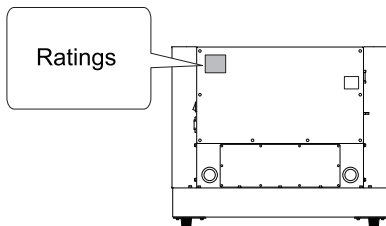

 **WARNING**

 **Never use out of doors or in any location where exposure to water or high humidity may occur. Never touch with wet hands.**
Doing so may result in fire or electrical shock.

 **Never allow any foreign object to get inside. Never expose to liquid spills.**
Inserting objects such as coins or matches or allowing beverages to be spilled into the ventilation ports may result in fire or electrical shock. If anything gets inside, immediately disconnect the power cord and contact your authorized Roland DG Corp. dealer.

 **WARNING**



Never place any flammable object nearby. Never use a combustible aerosol spray nearby. Never use in any location where gases can accumulate.

Combustion or explosion may be a danger.



Handle the power cord, plug, and electrical outlet correctly and with care. Never use any article that is damaged.

Using a damaged article may result in fire or electrical shock.



When using an extension cord or power strip, use one that adequately satisfies the machine's ratings (for voltage, frequency, and current).

Use of multiple electrical loads on a single electrical outlet or of a lengthy extension cord may cause fire.



When the machine will be out of use for a prolonged period, disconnect the power cord.

This can prevent accidents in the event of current leakage or unintended startup.



Connect to ground.

This can prevent fire or electrical shock due to current leakage in the event of malfunction.



Position so that the power plug is within immediate reach at all times.

This is to enable quick disconnection of the power plug in the event of an emergency. Install the machine next to an electrical outlet. Also, provide enough empty space to allow immediate access to the electrical outlet.

 **WARNING**



Never use cutting oil.

This machine is not designed for the flow of cutting oil. Oil may get inside the machine and cause fire or electrical shock.



Never use a pneumatic blower.

This machine is not compatible with a pneumatic blower. Cutting waste may get inside the machine and cause fire or electrical shock.



If sparking, smoke, burning odor, unusual sound, or abnormal operation occurs, immediately unplug the power cord. Never use if any component is damaged.

Continuing to use the machine may result in fire, electrical shock, or injury. Contact your authorized Roland DG Corp. dealer.

 Important notes about the power cord, plug, and electrical outlet

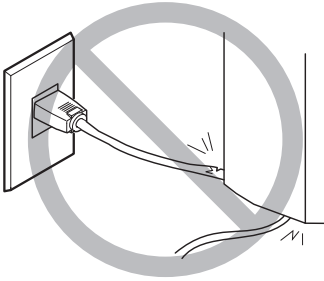

Never place any object on top or subject to damage.

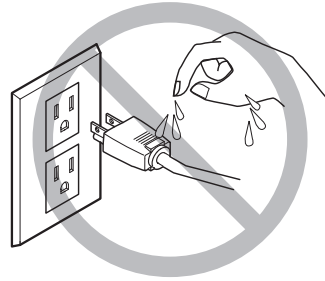

Never allow to get wet.

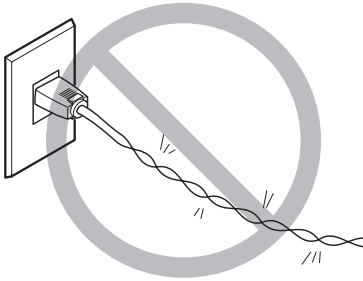

Never bend or twist with undue force.

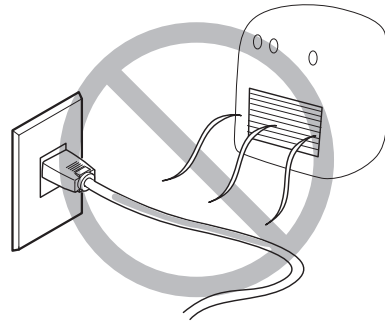

Never make hot.

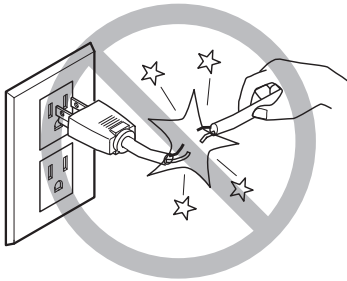

Never pull with undue force.

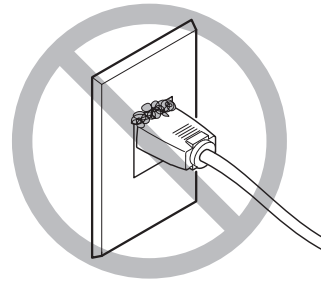

Dust may cause fire.

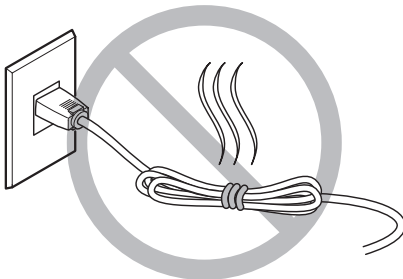

Never bundle, bind, or roll up.

 **Warning Labels**

Warning labels are affixed to make areas of danger immediately clear. The meanings of these labels are as follows. Be sure to heed their warnings. Also, never remove the labels or allow them to become obscured.



Caution: Pinching Hazard
Be careful not to allow the fingers to become pinched when closing the cover.

Front



Caution: High Temperature
Never touch immediately after cutting operation.

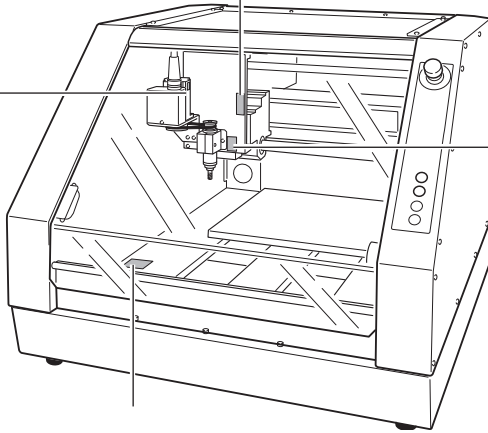

Caution: Sharp Tool
Inadvertent contact may cause injury.



Never use a pneumatic blower.

This machine is not compatible with a pneumatic blower. Cutting waste may get inside the machine and cause fire or electrical shock.

Rear

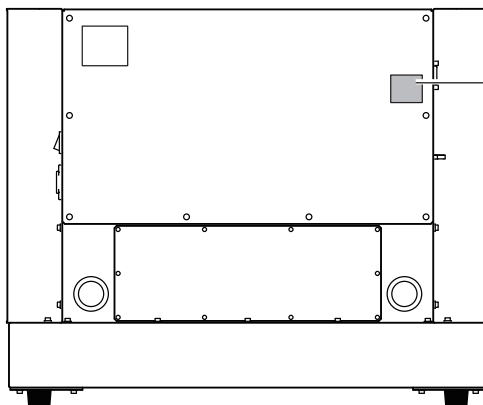



Caution: High Voltage
Cover removal may pose hazard of shock or electrocution due to high voltage.









Pour utiliser en toute sécurité

La manipulation ou l'utilisation inadéquates de cet appareil peuvent causer des blessures ou des dommages matériels. Les précautions à prendre pour prévenir les blessures ou les dommages sont décrites ci-dessous.

Avis sur les avertissements

 ATTENTION	Utilisé pour avertir l'utilisateur d'un risque de décès ou de blessure grave en cas de mauvaise utilisation de l'appareil.
 PRUDENCE	Utilisé pour avertir l'utilisateur d'un risque de blessure ou de dommage matériel en cas de mauvaise utilisation de l'appareil. * Par dommage matériel, il est entendu dommage ou tout autre effet indésirable sur la maison, tous les meubles et même les animaux domestiques.

À propos des symboles

	Le symbole  attire l'attention de l'utilisateur sur les instructions importantes ou les avertissements. Le sens précis du symbole est déterminé par le dessin à l'intérieur du triangle. Le symbole à gauche signifie "danger d'électrocution."
	Le symbole  avertit l'utilisateur de ce qu'il ne doit pas faire, ce qui est interdit. La chose spécifique à ne pas faire est indiquée par le dessin à l'intérieur du cercle. Le symbole à gauche signifie que l'appareil ne doit jamais être démonté.
	Le symbole  prévient l'utilisateur sur ce qu'il doit faire. La chose spécifique à faire est indiquée par le dessin à l'intérieur du cercle. Le symbole à gauche signifie que le fil électrique doit être débranché de la prise.

 **L'utilisation incorrecte peut causer des blessures**

 **ATTENTION**

 **S'assurer de suivre les procédures d'utilisation décrites dans la documentation. Ne jamais permettre à quiconque ne connaît pas le fonctionnement ou la manutention de l'appareil de le toucher.**

L'utilisation ou la manutention incorrectes peuvent causer un accident.



Garder les enfants loin de l'appareil. L'appareil comporte des zones et des composants qui présentent un danger pour les enfants et qui pourraient causer des blessures, la cécité, la suffocation ou d'autres accidents graves.



Ne jamais faire fonctionner l'appareil après avoir consommé de l'alcool ou des médicaments, ou dans un état de fatigue.

L'utilisation de l'appareil exige un jugement sans faille. L'utilisation avec les facultés affaiblies pourrait entraîner un accident.



Utiliser l'appareil dans un endroit propre et bien éclairé.

Travailler dans un endroit sombre ou encombré peut causer un accident; l'utilisateur risque, par exemple, de trébucher malencontreusement et d'être coincé par une partie de l'appareil.



Ne jamais utiliser l'appareil à des fins autres que celles pour lesquelles il est conçu. Ne jamais l'utiliser de manière abusive ou d'une manière qui dépasse sa capacité.

Le non-respect de cette consigne peut causer des blessures ou un incendie.

 **ATTENTION**



Ne jamais utiliser un outil de coupe émoussé. Procéder fréquemment aux travaux d'entretien pour garder l'appareil en bon état de fonctionnement.

L'usage abusif peut causer un incendie ou des blessures.



Débrancher le câble d'alimentation avant de procéder au nettoyage ou à l'entretien de l'appareil, et avant d'y fixer ou d'en retirer des accessoires en option.

Tenter ces opérations pendant que l'appareil est branché à une source d'alimentation peut causer des blessures ou un choc électrique.



Ne jamais tenter de démonter, de réparer ou de modifier l'appareil.

Le non-respect de cette consigne risque de provoquer un incendie, un choc électrique ou des blessures. Confier les réparations à un technicien ayant la formation requise.



PRUDENCE



Ne jamais grimper ni s'appuyer sur la machine.

La machine n'est pas conçue pour supporter le poids d'une personne. Grimper ou s'appuyer sur la machine peut déplacer des éléments et causer un faux pas ou une chute, ce qui causerait des blessures.



Ne pas utiliser si un couvercle avant est fissuré ou brisé.

Si le couvercle transparent à l'avant ou sur le côté de l'appareil est fissuré, communiquer avec le revendeur ou le centre de service autorisé de la société Roland DG.

 **Le poids de cet appareil est de 65 kg (144 lb.)**

 **PRUDENCE**



Le déchargement et la mise en place doivent être faits par au moins 4 personnes.

Les tâches qui exigent un effort trop grand si elles sont exécutées par un petit nombre de personnes peuvent être cause de blessures. La chute d'articles très lourds peut aussi causer des blessures.

 **PRUDENCE**



Installer l'appareil à un endroit stable et plat.

Installer l'appareil à un endroit inapproprié peut provoquer un accident grave comme le renversement ou la chute.

 **Les débris de coupe peuvent s'enflammer ou présenter un risque pour la santé.**

 **ATTENTION**



Ne jamais tenter de couper du magnésium ni aucun autre matériau inflammable.

Un incendie pourrait se produire pendant la coupe.



Ne pas approcher une flamme nue de l'espace de travail.

Les rognures de coupe peuvent s'enflammer. Les matériaux pulvérisés sont extrêmement inflammables et même le métal peut s'enflammer.

 **ATTENTION**



Si un aspirateur est utilisé pour ramasser les rognures de coupe, faire preuve de prudence pour empêcher que la poussière s'enflamme ou explose.

Ramasser des rognures fines à l'aide d'un aspirateur ordinaire peut créer un risque d'incendie ou d'explosion. Vérifier auprès du fabricant de l'aspirateur. Dans les cas où il est impossible de déterminer si un aspirateur peut être utilisé sans danger, se servir d'une brosse ou d'un article semblable plutôt que d'un aspirateur.

 **PRUDENCE**



Porter des lunettes de protection et un masque. Rincer toutes les rognures de coupe qui pourraient rester collées aux mains.

Avaler ou respirer accidentellement des rognures de coupe peut être dangereux pour la santé.

 Certains éléments peuvent présenter un risque de pincement, d’emmêlement, de brûlure ou d’autres dangers.

 **ATTENTION**



Ne jamais faire fonctionner l’appareil si on porte une cravate, un collier ou des vêtements amples. Bien attacher les cheveux longs.

Ces vêtements ou ces objets peuvent être coincés dans l’appareil, ce qui causerait des blessures.



Fixer solidement l’outil de coupe et la pièce à travailler. Une fois qu’ils sont fixés solidement, s’assurer qu’aucun outil ni aucun autre objet n’a été laissé en place.

Si tel était le cas, ces objets pourraient être projetés avec force hors de l’appareil et causer des blessures.

 **ATTENTION**



Faire preuve de prudence pour éviter l’écrasement ou le coincement.

La main ou les doigts peuvent être écrasés ou coincés s’ils entrent en contact avec certaines surfaces par inadvertance. Faire preuve de prudence pendant l’utilisation de l’appareil.



Attention : outil de coupe.

L’outil de coupe est acéré. Faire preuve de prudence pour éviter les blessures.



Attention : températures élevées.

L’outil de coupe et le moteur chauffent. Faire preuve de prudence pour éviter un incendie ou des brûlures.

 Risque de décharge ou de choc électrique, d’électrocution ou d’incendie

 **ATTENTION**



Ne pas utiliser avec une source d’alimentation électrique non conforme à la norme indiquée sur l’appareil.

Utiliser l’appareil avec une autre source d’alimentation risque de provoquer un incendie ou de causer une électrocution.

 **ATTENTION**



Ne jamais utiliser à l’extérieur ni à un endroit où l’appareil risque d’être exposé à de l’eau ou à une humidité élevée. Ne jamais toucher l’appareil avec des mains mouillées.

Le non-respect de cette consigne risque de provoquer un incendie ou un choc électrique.

Caractéristiques

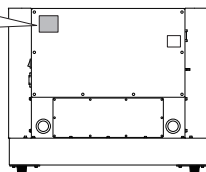

ATTENTION



Ne jamais insérer d'objet étranger dans l'appareil. Ne jamais exposer l'appareil aux déversements de liquides.

L'insertion d'objets comme des pièces de monnaie ou des allumettes, ou le déversement de liquides dans les orifices de ventilation peuvent causer un incendie ou un choc électrique. Si un objet ou du liquide s'infiltré dans l'appareil, débrancher immédiatement le câble d'alimentation et communiquer avec le représentant Roland DG autorisé.



Ne jamais placer d'objet inflammable à proximité de l'appareil. Ne jamais utiliser de produit inflammable en aérosol à proximité de l'appareil. Ne jamais utiliser l'appareil dans un endroit où des gaz peuvent s'accumuler.

Une combustion ou une explosion pourraient se produire.



Mise à la terre.

La mise à la terre peut prévenir un incendie ou un choc électrique dus à une fuite de courant en cas de défaillance.



Manipuler le câble d'alimentation, la fiche et la prise électrique correctement et avec soin.

Ne jamais utiliser un article endommagé, car cela pourrait causer un incendie ou un choc électrique.



Si une rallonge ou une bande d'alimentation électrique sont utilisées, s'assurer qu'elles correspondent aux caractéristiques de l'appareil (tension, fréquence et courant).

L'utilisation de plusieurs charges électriques sur une prise unique ou une longue rallonge peut causer un incendie.

ATTENTION



Si l'appareil doit rester inutilisé pendant une longue période, débrancher le câble d'alimentation.

Cela peut prévenir les accidents en cas de fuite de courant ou de démarrage accidentel.



Placer l'appareil de façon à ce que la fiche soit facile d'accès en tout temps.

Ainsi, l'appareil pourra être débranché rapidement en cas d'urgence. Installer l'appareil près d'une prise électrique. En outre, prévoir suffisamment d'espace pour que la prise électrique soit facile d'accès.



Ne jamais utiliser d'huile de coupe.

Cet appareil n'est pas conçu pour traiter l'huile de coupe. L'huile peut s'infiltrer à l'intérieur et causer un incendie ou un choc électrique.



Ne jamais utiliser d'air sous pression.

Cet appareil n'est pas conçu pour être nettoyé à l'aide d'un appareil soufflant. Des rognures de coupe peuvent s'infiltrer à l'intérieur et causer un incendie ou un choc électrique.



S'il se produit des étincelles, de la fumée, une odeur de brûlé, un bruit inhabituel ou un fonctionnement anormal, débrancher immédiatement le câble d'alimentation. Ne jamais utiliser si un composant est endommagé.

Continuer à utiliser l'appareil peut causer un incendie, un choc électrique ou des blessures. Communiquer avec le représentant Roland DG Autorisé.

 Remarques importantes à propos du câble d'alimentation, de la fiche et de la prise électrique

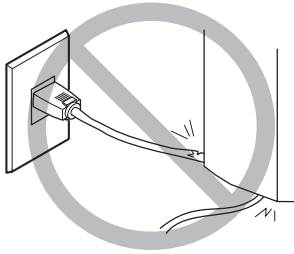

Ne jamais déposer aucun objet sur le câble, sur la fiche ou sur la prise car cela risque de les endommager.

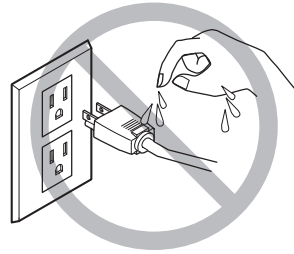

Ne jamais laisser l'eau toucher le câble, la fiche ou la prise.

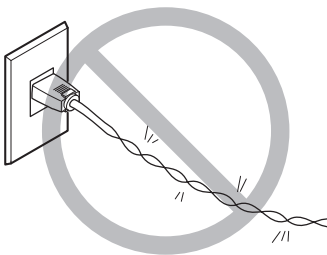

Ne jamais plier ni tordre le câble avec une force excessive.

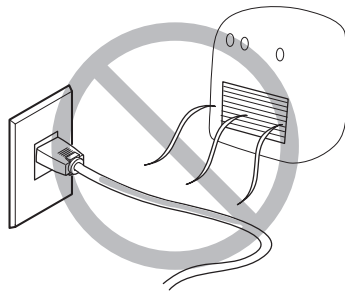

Ne jamais chauffer le câble, la fiche ou la prise.

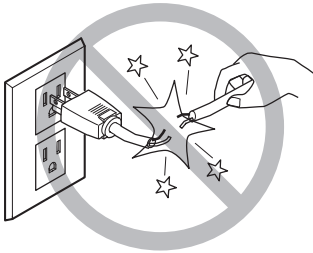

Ne jamais tirer sur le câble ou la fiche avec une force excessive.

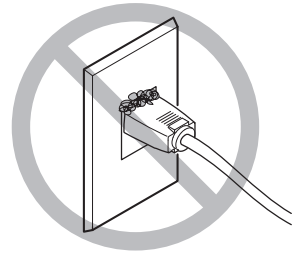

La poussière peut causer un incendie.

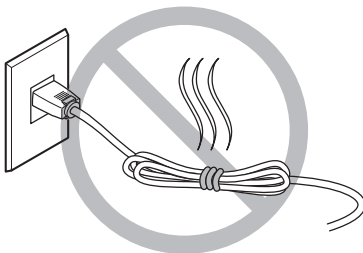

Ne jamais plier ni enrrouler le câble.

Vignettes d'avertissement

Des vignettes d'avertissement sont apposées pour qu'il soit facile de repérer les zones dangereuses. La signification des vignettes est donnée ci-dessous. Respecter les avertissements.

Ne jamais retirer les vignettes et ne pas les laisser s'encrasser.

Avant



Attention : risque de pincement

Faites attention de ne pas coincer les doigts lors de la fermeture du couvercle.



Attention : température élevée

Ne jamais toucher immédiatement après une opération de coupe.

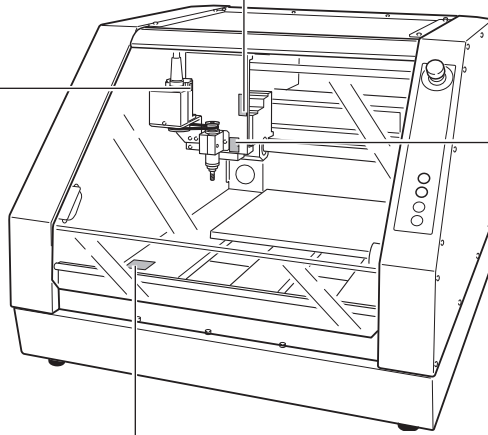

Attention : outil coupant

Un contact imprudent risque d'entraîner une blessure.



Ne jamais utiliser d'air sous pression.

Cet appareil n'est pas conçu pour être nettoyé à l'aide d'un appareil soufflant. Des rognures de coupe peuvent s'infiltrer à l'intérieur et causer un incendie ou un choc électrique.

Arrière

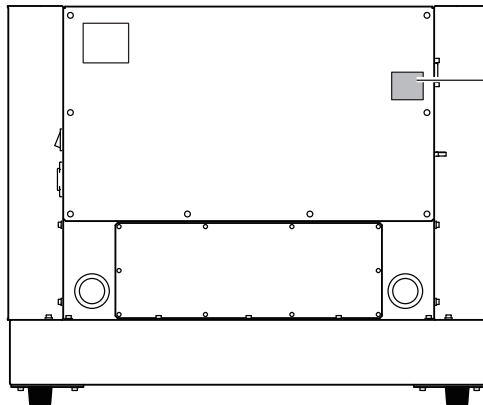

Attention : voltage élevé

Il peut être dangereux de retirer le couvercle puisqu'il y aurait des risques de chocs électriques ou d'électrocution à cause du voltage élevé.

Important Notes on Handling and Use

This machine is a precision device. To ensure the full performance of this machine, be sure to observe the following important points. Failure to observe these may not only result in loss of performance, but may also cause malfunction or breakdown.

This machine is a precision device.

- Handle carefully, and never subject the machine to impact or excessive force.
- Diligently keep clean of cutting waste.
- Use within the range of specifications.
- Never attempt to move the spindle unit by hand with undue force.
- Never needlessly touch anywhere inside the machine except for locations specified in this manual.

Install in a suitable location.

- Install in a location that meets the specified conditions for temperature, relative humidity, and the like.
- Install in a quiet, stable location offering good operating conditions.
- Never install in out of doors.
- Never use the machine in an environment where silicone substances (oil, grease, spray, etc.) are present. Doing so may cause poor switch contact.

This machine becomes hot.

- Never cover the ventilation holes with cloth, tape, or anything else.
- Install in a well-ventilated location.

About Cutters

- Use a cutter that is suitable for the workpiece and the cutting method.
- The tip of the cutter is breakable. Handle with care, being careful not to drop it.

This machine is suited to cutting resins.

- Never use it to cut metal.

About the Documentation for This Machine

Documentation Included with the Machine

The documentation for this machine is organized as described below. Read through the documents you need to ensure that you get full use of the machine.



Be sure to read this.



Read as required.



MDX-40A
User's Manual (this document)

When installing the machine
When you want to learn about use
of this unit.



SRP Player Install Guide

When installing and setting up the
included CAM program.



NC Code Reference MANUAL
(electronic-format manual)

When performing NC-code program-
ming
You can find it on the included Ro-
land Software Package CD-ROM.

Installing the NC Code Reference MANUAL

For more information about the system configuration required for installation and setup, refer to page 36, "Installing and Setting Up the Software."

- 1 Log on to Windows as "Administrators."
- 2 Insert the Roland Software Package CD-ROM into the computer.
(Windows Vista: When the automatic playback window appears, click [Run menu.exe].)

The setup menu appears automatically.

3

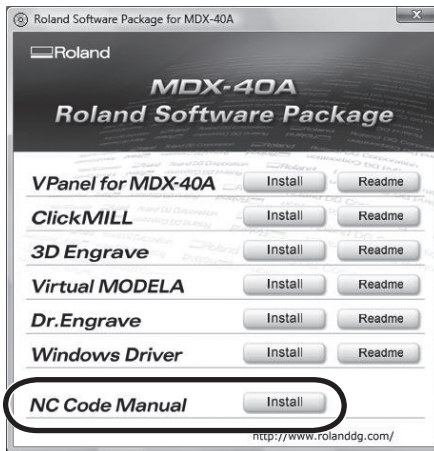

Click [NC Code Manual Install].

Setup menu

- 4 Follow the messages to install the program.
(Windows Vista: The [User Account Control] appears, click [Allow]. Follow the messages to install the program.)
- 5 Click  of the install window to complete the installation.

Viewing the NC Code Reference MANUAL

From the [Start]  menu, click [NC Code Reference Manual] – [NC Code Reference Manual].

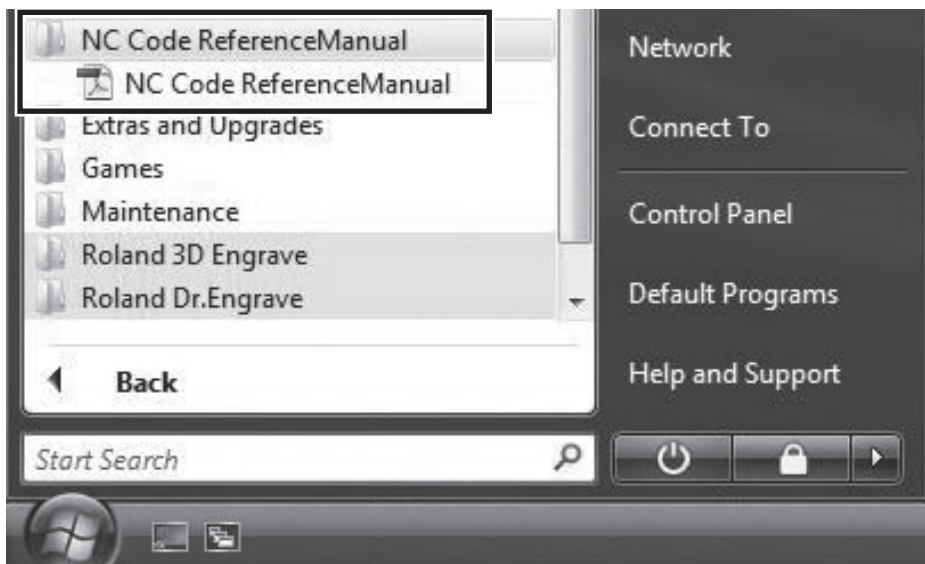

Chapter 1

Getting Started

This section describes the features of the machine, the part names, and the functions.

1-1 Machine Highlights	24
Overview of the Unit	24
Operating the Machine	24
1-2 Part Names and Functions	25
Front	25
Side	26
VPanel	27
Built-in Panel	28

1-1 Machine Highlights

Overview of the Unit

RML-1/NC code support

This machine supports both RML-1 and NC code; therefore it is applicable for a wide-range of software. RML-1 is a control command exclusive to Roland D.G. modeling machine. When outputting from the included application to the machine.

Easy-operation VPanel

This machine is operated from the computer screen by using the included application software, "VPanel." The VPanel moves the tool, turns on/off the spindle rotation, sets the origin, and outputs the cutting data.

A full array of software included

In order to enable modeling immediately after the cutting data is created, the exclusive CAM softwares are included. Cutting software is also included to meet various usages.

☞ P. 37 "The Software You Can Install and Set Up"

Four-axes machining operation support

Installing the optional rotary axis unit (A-axis) makes it possible to perform four-axes machining operations such as multiple-surface cutting.

Operating the Machine

This machine is operated from the computer screen by using the included exclusive application software, "VPanel." You can find it on the included Roland Software Package CD-ROM.

☞ P. 27, "VPanel," p. 39, "Installing VPanel and Other Softwares"

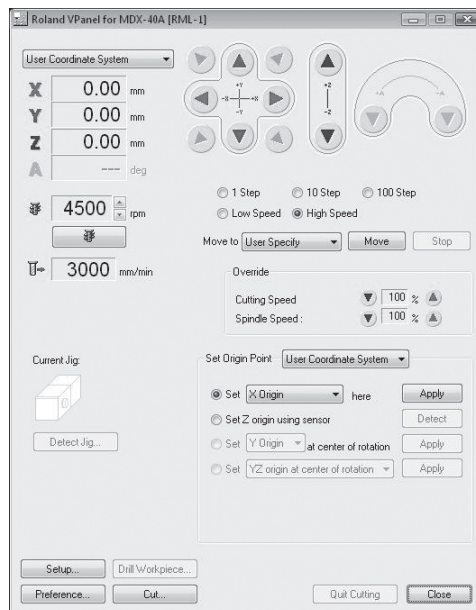

1-2 Part Names and Functions

Front

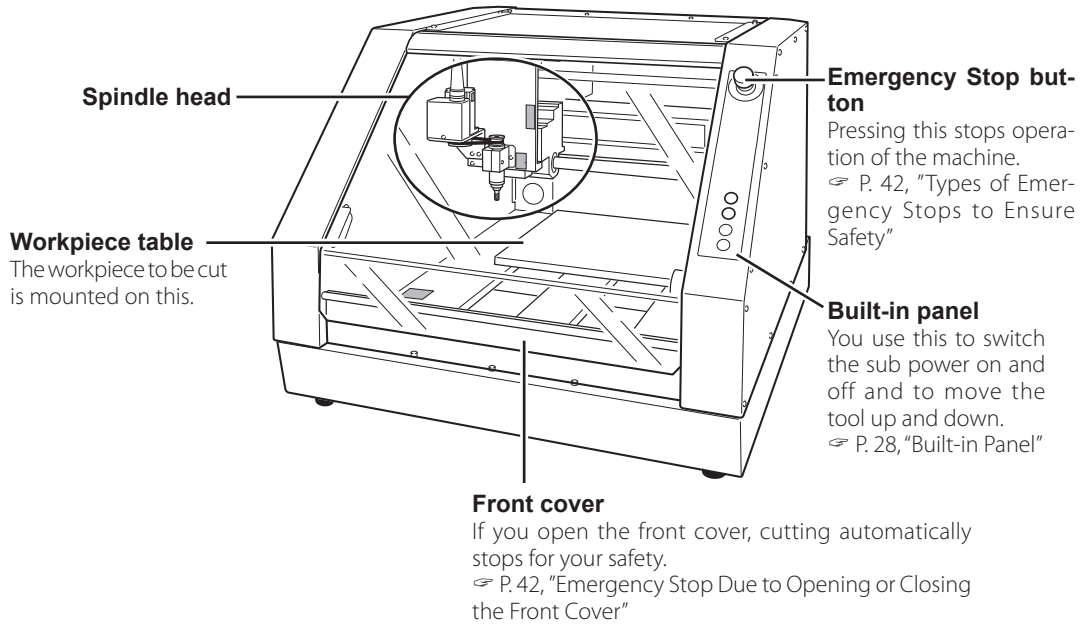

* In this manual, the mechanisms around the spindle unit, including the spindle motor, are called the "spindle head." Also, the rotary-axis area inside the spindle unit is called the "spindle."

Side

Right side

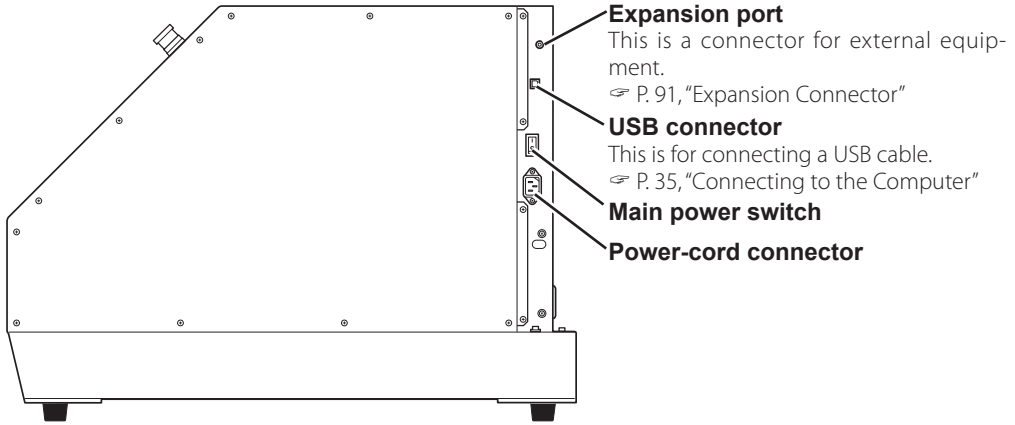

Left side

Sensor connector
Connect the supplied sensor cable to this connector.
☞ P. 70, "Setting the Z Origin Using the Z0 Sensor"

Rotary Axis Unit Connector
This is the terminal to connect the optional rotary axis unit.
☞ P. 91, "Expansion Connector"

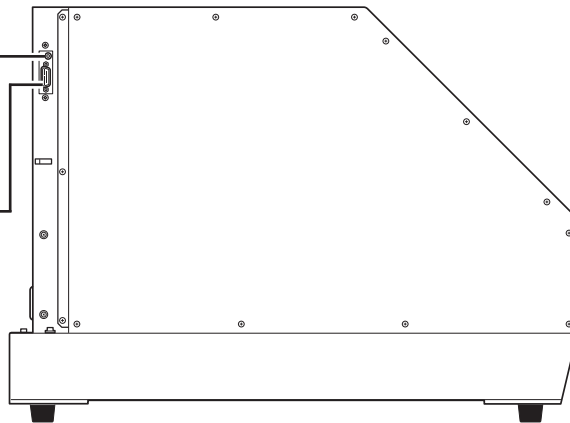

VPanel

Operation of the machine is controlled from the screen of your computer. VPanel is a dedicated software for controlling the machine.

① Coordinates

This displays the present tool location.

☞ P. 49, "About the Displayed Tool Position"

② Feed buttons

These perform movement along the respective axes (X, Y, and Z).

☞ P. 48, "Manual Feed"

③ Specific-destination movement button

You use this to make the tool move directly to a specific position.

☞ P. 51, "Moving to a Specific Position"

④ Override buttons

These change the speed of spindle rotation and other aspects of cutting operations.

☞ P. 68, "Override"

⑤ Base-point setting buttons

These set the base points used during cutting, such as the X- and Y-axes origin points.

⑥ Spindle speed

This displays the present rotating speed of the spindle. Changing the speed is also possible.

⑦ Spindle-rotation button

This switches spindle rotation on and off.

☞ P. 52, "Starting and Stopping Spindle Rotation"

⑧ Tool feed rate

This displays the present speed of tool movement.

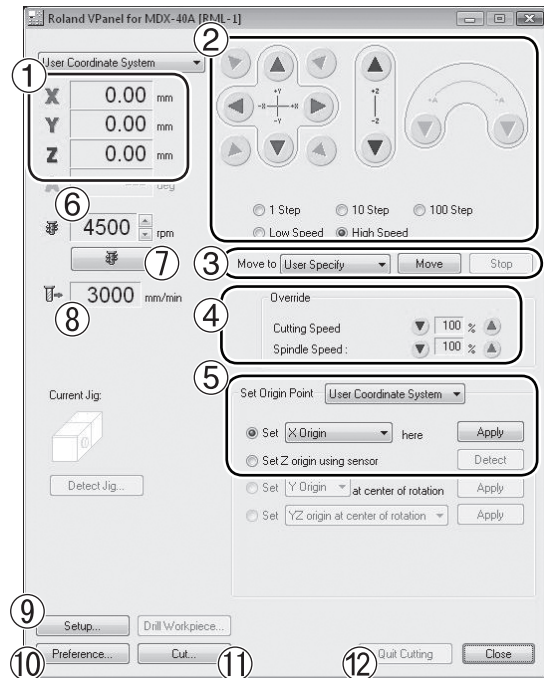

⑨ Setup button

This is used at times such as when setting the detailed operation of the machine, selecting the command sets, and others.

☞ P. 46, "Selecting the Command Set"

⑩ Preference button

The unit of measurement used for displaying coordinates can be changed.

☞ P.50, Changing the Unit of Measurement for Display

⑪ Cut button

Record the cutting data in text file format to VPanel and output to the machine.

☞ P. 65, "Start Cutting (output via VPanel)"

⑫ Quit Cutting button

The cutting operation stops. This button is displayed only during cutting operation.

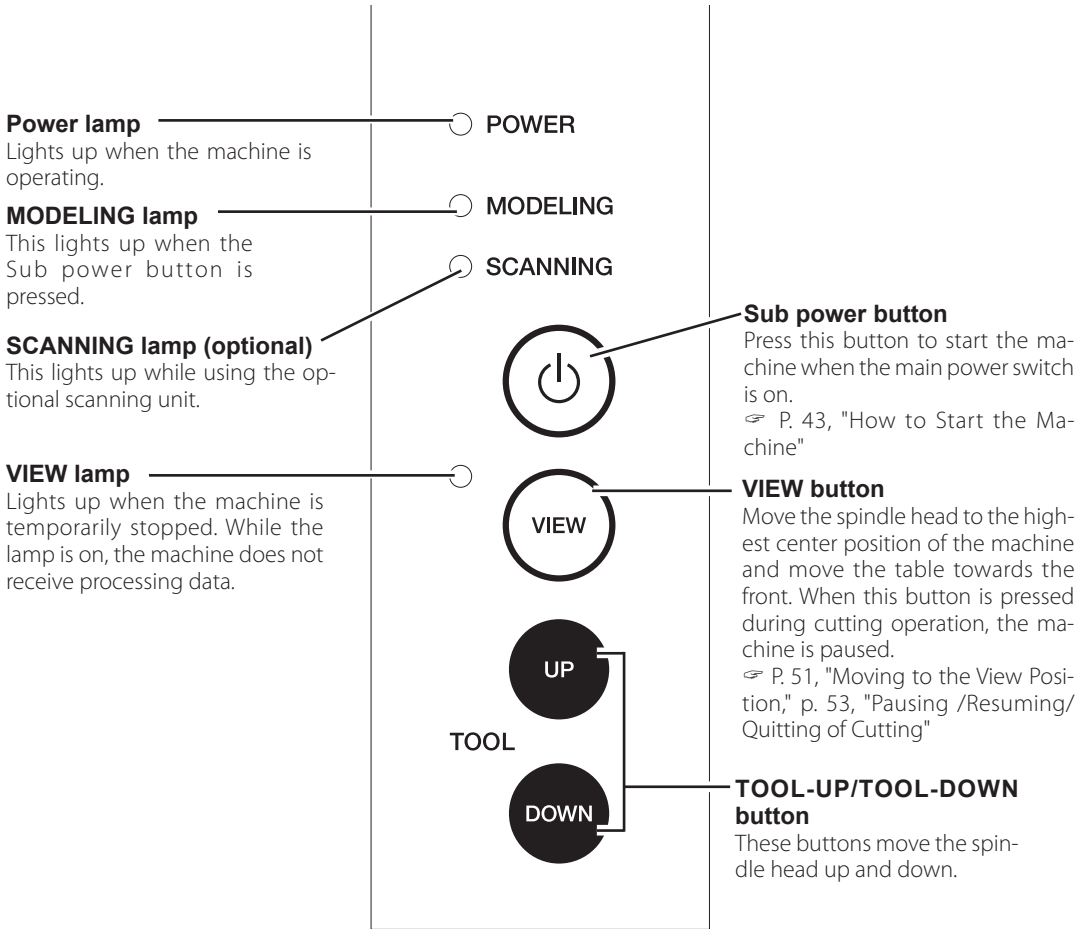

☞ P. 55 "Quitting Cutting by Operating from the VPanel"

Built-in Panel



Displayed lamps in this document

Lamp status in this document is described below.

Display	Status
	Lights
	Flashes
	Dark

Chapter 2





Installation and Setup

This describes what you need to do before you use the machine, including checking and verifying the included items, how to install the machine, and how to install and set up the included softwares.

2-1	Checking the Included Items	30
2-2	Installation.....	31
	Installation Environment	31
	Installation Environment	31
	Removing and Storing the Retainers.....	33
2-3	Cable Connections	34
	Connecting the Power Cord	34
	Connecting to the Computer.....	35
2-4	Installing and Setting Up the Software.....	36
	System Requirements	36
	The Software You Can Install and Set Up	37
	Installing the Windows-based Driver	38
	Installing VPanel and Other Softwares.....	39
	Viewing the Documentation for the Softwares.....	40

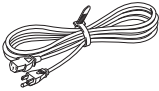
2-1 Checking the Included Items

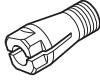
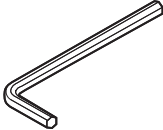
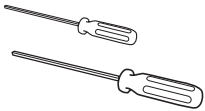
The following items are included with the machine. Make sure they are all present and accounted for.

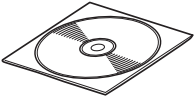
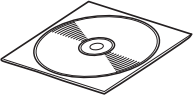
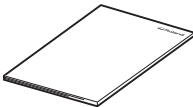
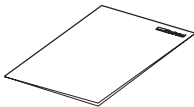
			
Power cord	USB cable	Collet	Hexagonal wrench
			
Hexagonal screw drivers	Spanners	Z0 Sensor	Roland Software Package CD-ROM
			
SRP Player CD-ROM	User's Manual (this document)	SRP Player Installation and Setup Guide	

2-2 Installation

Installation Environment

- ⚠️ WARNING** **Unloading and emplacement are operations that must be performed by 4 persons or more.**
Tasks that require undue effort when performed by a small number of persons may result in physical injury. Also, if dropped, such items may cause injury.

The weight of the machine alone is 65 kg (144 lb.). Perform unloading and emplacement with care.

Installation Environment

Install in a quiet, stable location offering good operating conditions. An unsuitable location can cause accident, fire, faulty operation, or breakdown.

- ⚠️ WARNING** **Install in a location that is level and stable.**
Installation in an unsuitable location may cause an accident, including a fall or tipover.

- ⚠️ WARNING** **Never install in a location exposed to open flame.**
Cutting waste may ignite. Powdered material is extremely flammable, and even metal material may catch fire.

- ⚠️ WARNING** **Never install close to any flammable object or in a gas-filled location.**
Combustion or explosion may be a danger.

- ⚠️ WARNING** **Never install out of doors or in any location where exposure to water or high humidity may occur.**
Doing so may result in fire or electrical shock.

- ⚠️ WARNING** **Position so that the power plug is within immediate reach at all times.**
This is to enable quick disconnection of the power plug in the event of an emergency. Install the machine next to an electrical outlet. Also, provide enough empty space to allow immediate access to the electrical outlet.

- Never install in a location subject to wide fluctuations in temperature or humidity.
- Never install in a location subject to shaking or vibration.
- Never install in a location where the floor is tilted, not level, or unstable.
- Never install in a dusty or dirty location, or out of doors.
- Never install in a location exposed to direct sunlight or near air-conditioning or heating equipment.
- Never install in a location exposed to considerable electrical or magnetic noise, or other forms of electromagnetic energy.
- Never install in an environment where silicone substances (oil, grease, spray, etc.) are present.

Installation Space

Ensure that at least the following amount of space is available.

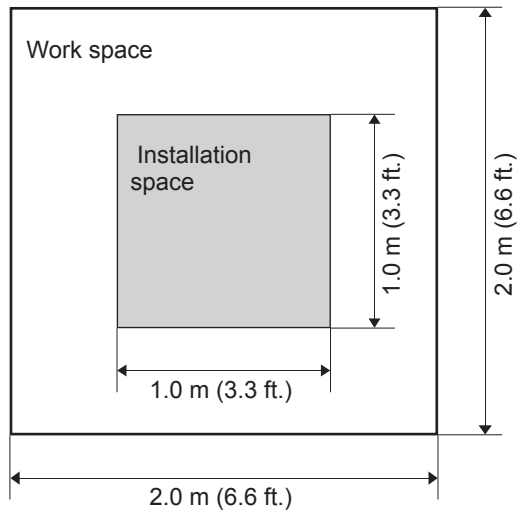

Height of Installation

The height of installation should be 0.6 m (23.7 in.) or higher above the work floor.

This machine is desktop type. Please decide the height of installation so that you can easily reach the emergency stop button when operating this machine.

Removing and Storing the Retainers

Retaining materials are attached to protect the machine from vibration during shipment. When installation is complete, remove these and store in the specified locations.

- Remove all Retaining materials. Any that remain may cause faulty operation or breakdown when the power is switched on.
- The Retaining materials are required when moving the machine to a different location. Store them carefully so that they do not get misplaced.

⚠WARNING Carry out these operations before you connect the power cord. Inadvertent powerup may result in pinched hands or other injury.

Procedure

- 1 Make sure the power cord is not connected.
- 2 Remove the screws shown in the figure, then detach these retainers.

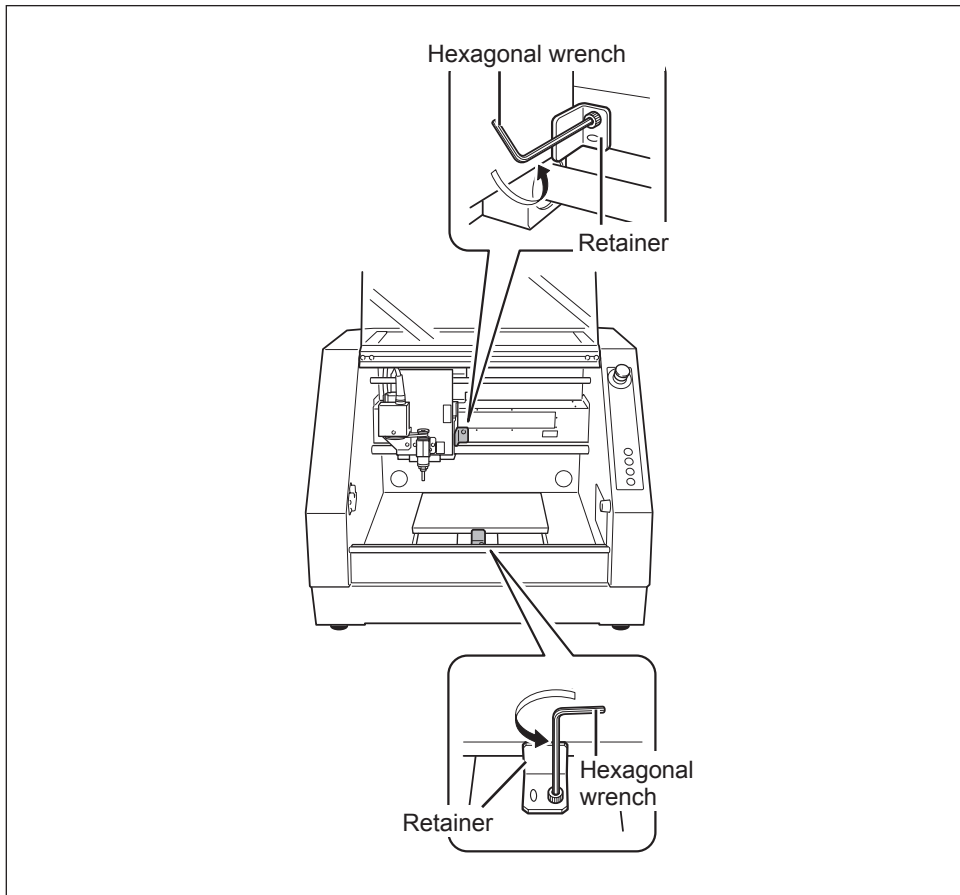

2-3 Cable Connections

Connecting the Power Cord

⚠ WARNING

Do not use with any electrical power supply that does not meet the ratings displayed on the unit.

Use with any other power supply may lead to fire or electrocution.

⚠ WARNING

Handle the power cord, plug, and electrical outlet correctly and with care. Never use any article that is damaged.

Using a damaged article may result in fire or electrical shock.

⚠ WARNING

When using an extension cord or power strip, use one that adequately satisfies the machine's ratings (for voltage, frequency, and current).

Use of multiple electrical loads on a single electrical outlet or of a lengthy extension cord may cause fire.

⚠ WARNING

Connect to ground.

This can prevent fire or electrical shock due to current leakage in the event of malfunction.

⚠ WARNING

Connect to an electrical outlet. Never connect directly to a power distribution panel or other such fixed wiring equipment.

Doing so increases the hazard of fire or electrical shock.

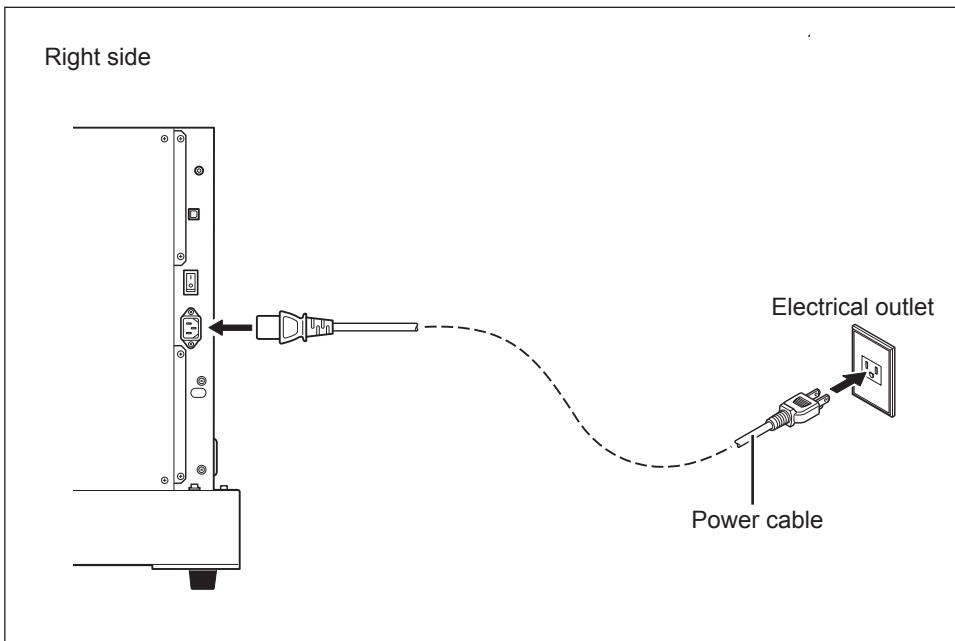

Connecting to the Computer

USB cable

At this time, the connection to the computer must not be made yet. You make the connection to the computer when you install the Windows-based driver.

- Be sure to make the connection according to the instructions on page 38, "Installing the Windows-based Driver." Making the connection without doing so may cause driver installation to fail and make use impossible.
- Never connect two or more machines to one computer.
- For the USB cable, use the included cable.
- Never use a USB hub.

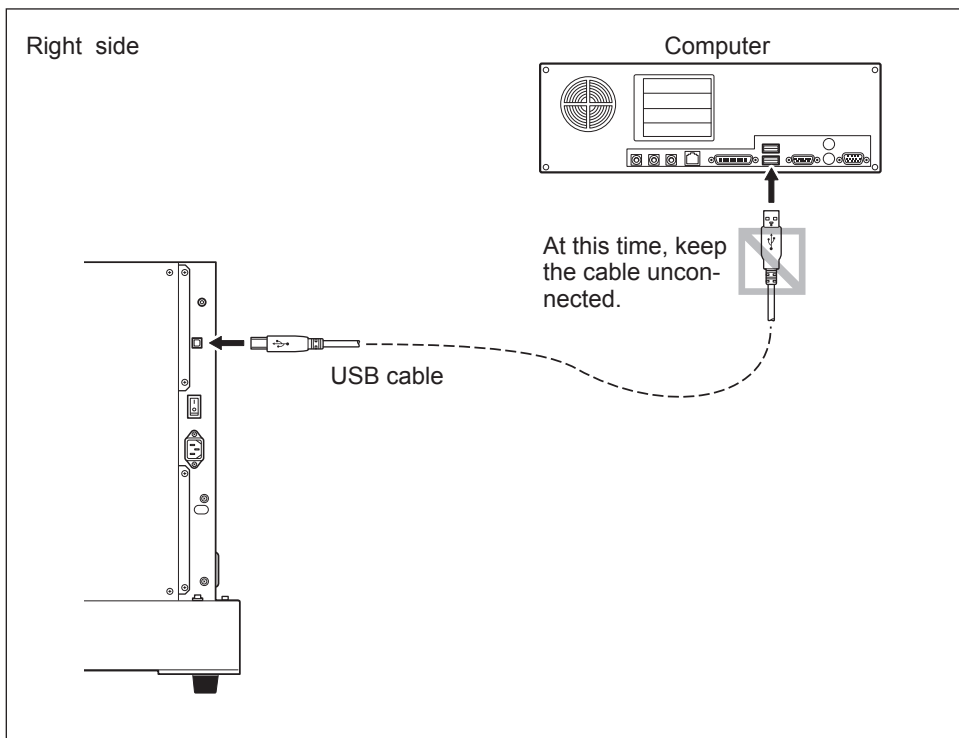

2-4 Installing and Setting Up the Software

System Requirements

Operating system	Windows XP/Vista (32 bit edition) (Internet Explorer 4.0 or later required)
Processor	The minimum required CPU for the operating system
Memory	The minimum amount of required RAM for the operating system
Optical drive	CD-ROM drive
Free hard-disk space required for installation	52 MB
Video card and monitor	At least 256 colors with a resolution of 1,024 x 768 or more recommended

This table shows the minimum system requirements for using a variety of applications and the Windows-based driver (MDX-40A) included on the Roland Software Package CD-ROM. For the system requirements for SRP Player, refer to its user's manuals.

For the latest information, see the Roland DG Corp. website (<http://www.rolanddg.com>).

The Software You Can Install and Set Up

VPanel for MDX-40A	This is a dedicated software for controlling this machine. You operate this machine and make various settings using this software.
Windows driver	This is a Windows-based driver required for sending data from a computer to the machine.
SRP Player	This is a CAM software that imports general-use 3D data, such as IGES, DXF (3D), or STL, and outputs tool paths to the machine. Note: For information on installation and setup, refer to the separate SRP Player Installation and Setup Guide.
Dr. Engrave	This is a software for engraving text and shapes. It can use any TrueType fonts registered with Windows. It also comes with its own stroke fonts.
3D Engrave	This software is for designing and engraving reliefs (raised engravings), supporting flat engraving. This lets you easily add thickness to text, shapes, and imported images, and create three-dimensional reliefs.
Virtual MODELA (for 3D Engrave)	This software is for performing simulations before you actually carry out cutting using 3D Engrave. It lets you verify the finished results for shapes, the time required for cutting, and other factors.
ClickMILL	This software is useful for post-cutting the material, for example, cutting the inner side of shapes ("pocket-cutting"), cutting out the material to the specified shape ("cutout"), or cutting the surface of the material to a uniform depth ("surface leveling").



Point

Information on how to use the included software is found in electronic-format manual for each software.

☞ P. 40, "Viewing the Documentation for the Softwares"

Installing the Windows-based Driver

Notice

Keep the machine and the computer unconnected until you carry out this installation operation. Failure to follow the correct procedure may make installation impossible.

☞ P. 80, "Installation is impossible"

Procedure

- 1 Before you start installation and setup, make sure the USB cable is NOT connected.
- 2 Log on to Windows as "Administrators."
- 3 Insert the Roland Software Package CD-ROM into the computer.
(Windows Vista only: When the automatic playback window appears, click [Run menu.exe].)
The setup menu appears automatically.

4



Setup menu

Click [Install] of "Windows Driver".

An Installation and Setup Guide matched to the basic software on your computer is displayed.

5

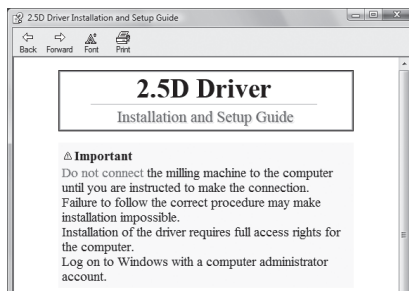

Installation and Setup Guide

Follow the instructions in the Installation and Setup Guide to finish installing.

Installing VPanel and Other Softwares

Procedure

- 1 Display the window for the setup menu.

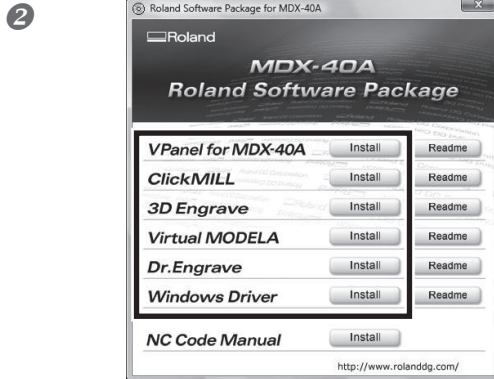

Click [Install] of "VPanel for MDX-40A" or the program you want to install.

- 3 Follow the messages to install the softwares.
(Windows Vista only: The [User Account Control] appears, click [Allow], and install the softwares.)

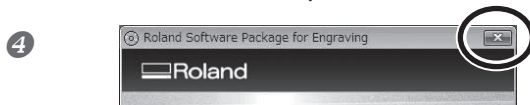

When all installation finishes, click  of the setup menu.

- 5 Remove the CD-ROM from the CD-ROM drive.

Viewing the Documentation for the Softwares

The documentation for the softwares is in electronic format. Follow the procedure below to view it. From the [Start] (Windows logo) menu, choose the software you're using, then click [Help].

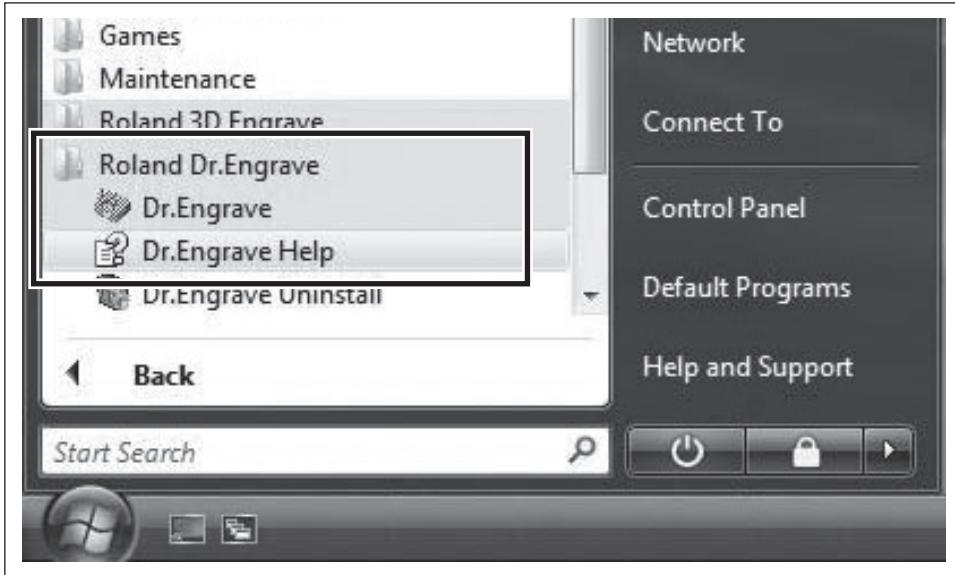

Chapter 3

Basic Operation

This describes the basic operation methods. If you're using the machine for the first time, then before you start operations, be sure to read this.

3-1	Types of Emergency Stops to Ensure Safety	42
	How to Perform an Emergency Stop.....	42
	To Cancel an Emergency Stop.....	42
	Emergency Stop Due to Opening or Closing the Front Cover	42
3-2	Starting and Quitting.....	43
	How to Start the Machine	43
	Shutdown.....	45
3-3	Selecting the Command Set.....	46
	What is Command Set?.....	46
	Selecting Command Set.....	46
3-4	Moving the Tool.....	48
	Manual Feed.....	48
	About the Displayed Tool Position	49
	Moving to a Specific Position.....	51
	Moving to the VIEW Position	51
3-5	Starting and Stopping Spindle Rotation.....	52
	Starting or Stopping the Spindle.....	52
3-6	Pausing/Resuming/Quitting of Cutting.....	53
	Pausing and Resuming of Cutting by Operation of the Machine	53
	Quitting Cutting by Operation of the Machine.....	54
	Quitting Cutting by Operating from the VPanel	55

3-1 Types of Emergency Stops to Ensure Safety

How to Perform an Emergency Stop.

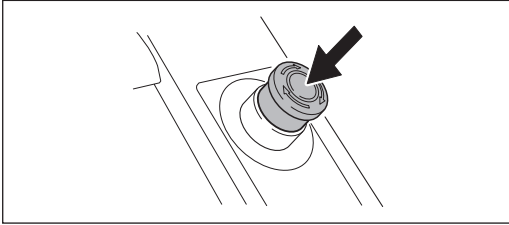

Press the Emergency Stop button.

Operation stops immediately.

To Cancel an Emergency Stop

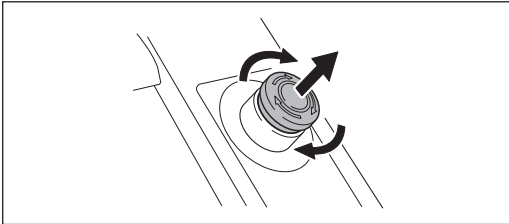

Turn the button in the direction of the arrows.

Emergency Stop Due to Opening or Closing the Front Cover

To ensure safety, opening a front cover during cutting or spindle rotation causes an emergency stop to occur. At the operation panel, the MODELING lamp and the VIEW lamp flash. Operation cannot be resumed by closing the front cover. In order to resume the operation, restart the machine following the instruction displayed on the VPanel.

☞ P. 43, "Starting and Quitting"

3-2 Starting and Quitting

How to Start the Machine

Follow the procedure below to start the machine. When startup is complete, the machine is ready for use.

Procedure

1

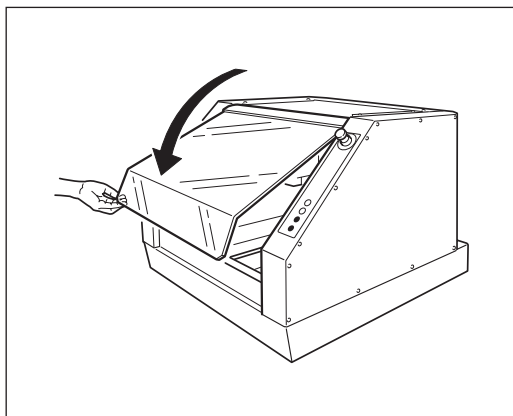

Close the front cover.

2

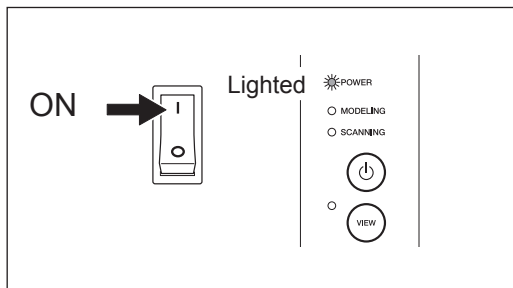

Switch on the main power switch.

The POWER lamp comes on.

3

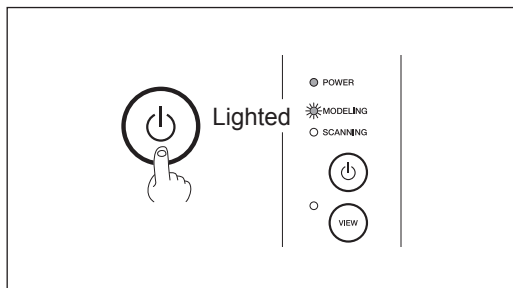

Press the Sub power button.

The table moves to the back of the machine, and the spindle head moves to the highest left position of the machine. The SCANNING and MODELING lamp flash at this time. This operation is called initialization. When the MODELING lamp stops flashing and remains steadily lighted, initialization is complete.

3-2 Starting and Quitting

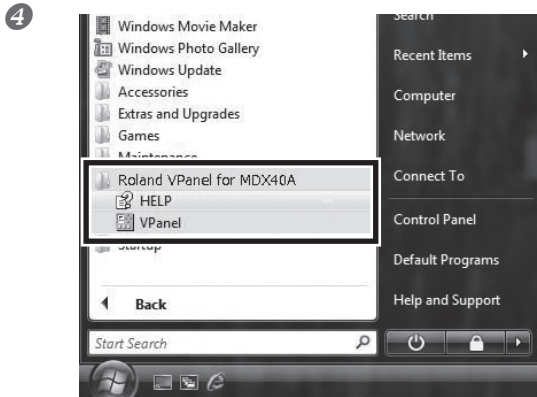

On the computer, start VPanel.
From the [Start] menu, click [All Programs] - [Roland VPanel for MDX 40A] - [VPanel].

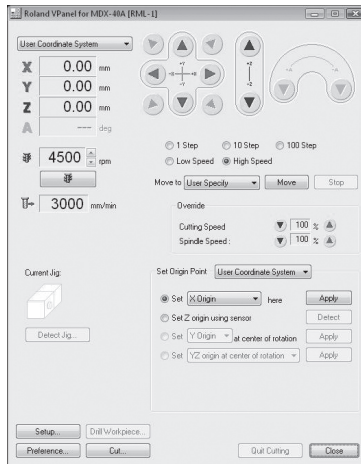

The window shown in the figure appears.
Startup of the machine is complete.

Shutdown

Procedure

1

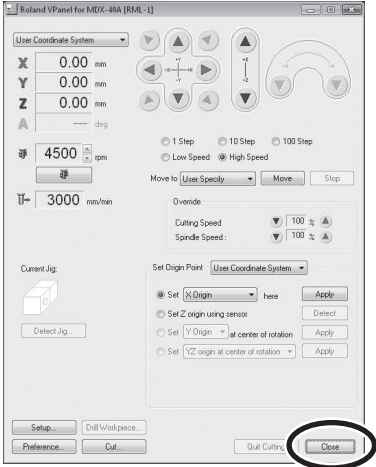

On the computer, quit VPanel.

2

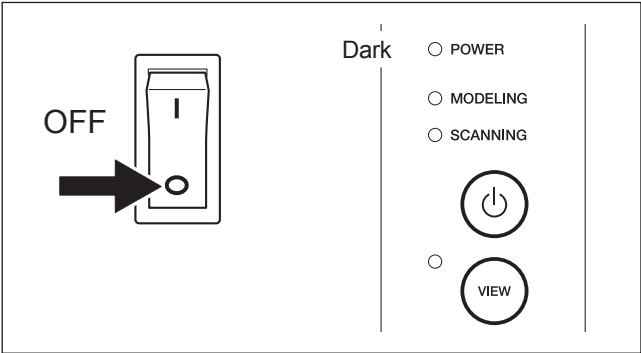

Switch off the main power switch.
 The POWER and MODELING lamp go dark and the power to the machine is switched off.

3-3 Selecting the Command Set

What is Command Set?

In this machine, the following command sets are available for selection.

- **RML-1**
Select when you want to use the software that is included with the machine.
- **NC code**
Select when you want to use the NC code. For the details of NC code, refer to "NC Code Specification" on page 87 and "NC Code Reference Guide" that is included with the machine.
- **Selected automatically (RML-1/NC Code)**
The machine becomes ready to accept the cutting programs of RML-1 and NC code command sets.

Select the appropriate command mode to match the application software to be used. If a command that is sent to the machine is different from the command set selected on the VPanel, an error occurs and cutting becomes impossible.

Command set is displayed on the title bar of the VPanel. The setting at shipping from the factory is "RML-1."

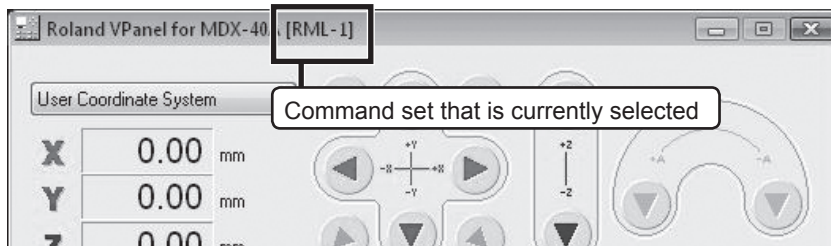

Selecting Command Set

Procedure

1 Start the machine.

☞ P. 43, "How to Start the Machine"

2

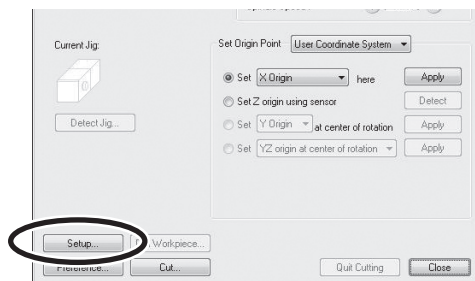

Click the [Setup] button on the VPanel.

The "Setup" screen appears.

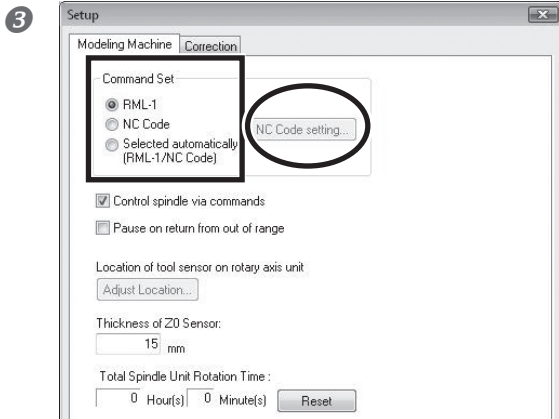

Select a command set by using “Modeling Machine” tab.

When "NC Code" or "Selected automatically (RML-1/NC Code)" is selected, the [NC Code setting...] becomes enabled, and the setting related to NC code becomes available. For the details of NC code setting, refer to the Help for VPanel.

☞ P. 40, "Viewing the Documentation for the Softwares"

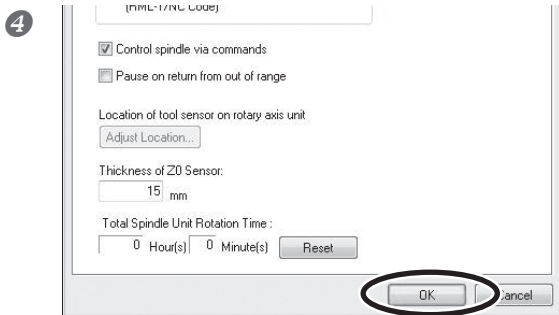

Click [OK].

3-4 Moving the Tool

Manual Feed

Moving the tool manually is called "manual feed," and you can accomplish this using the feed buttons in VPanel.

Note: Manual feed cannot be performed while a cutting operation is in progress.

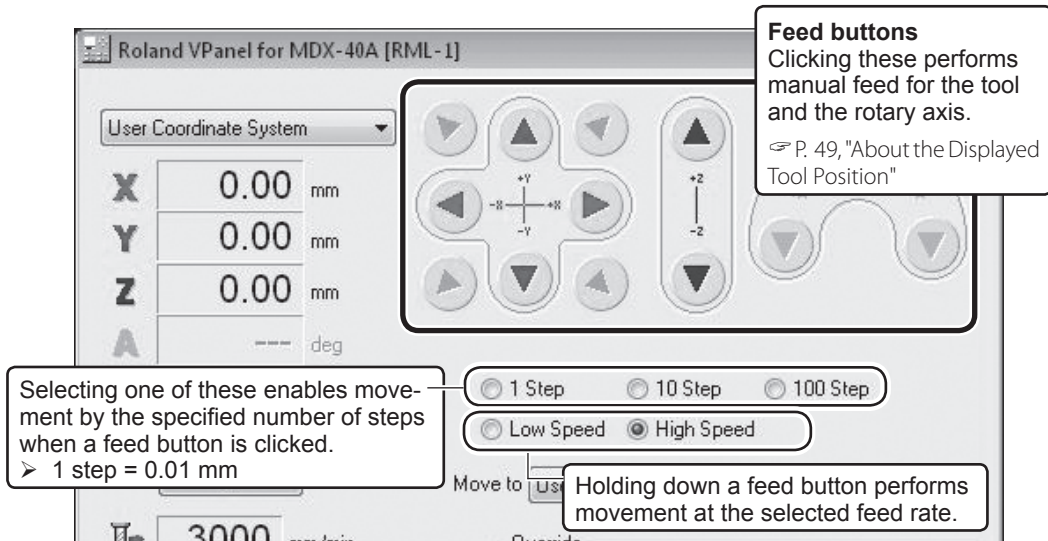

Table Movement When a Y-axis Feed Button Is Clicked

Under the default setting, Y-axis movement assumes a direction of tool movement relative to the object being cut. This means that clicking a Y-axis feed button makes the table move in a direction different from what the arrow indicates.

About the Displayed Tool Position

Coordinate View

The main window in VPanel displays the present location of the tool as numerical values. Using these lets you perform manual feed accurately, which can be very convenient in tasks such as aligning the workpiece.

The numerical values that indicate the location of the tool are called "coordinates," and the starting point for the coordinates is called the "origin." The following figure shows a location that is shifted from the origin by 50 millimeters along the X-axis, 30 millimeters along the Y-axis, and 20 millimeters along the Z-axis. This X-axis distance is called the "X-axis coordinate" (or sometimes just the "X coordinate"), and the Y- and Z-axis distances are similarly called the "Y-axis coordinate" and the "Z-axis coordinate." The distances from the origin for the respective axes to the tool are therefore the corresponding coordinate values.

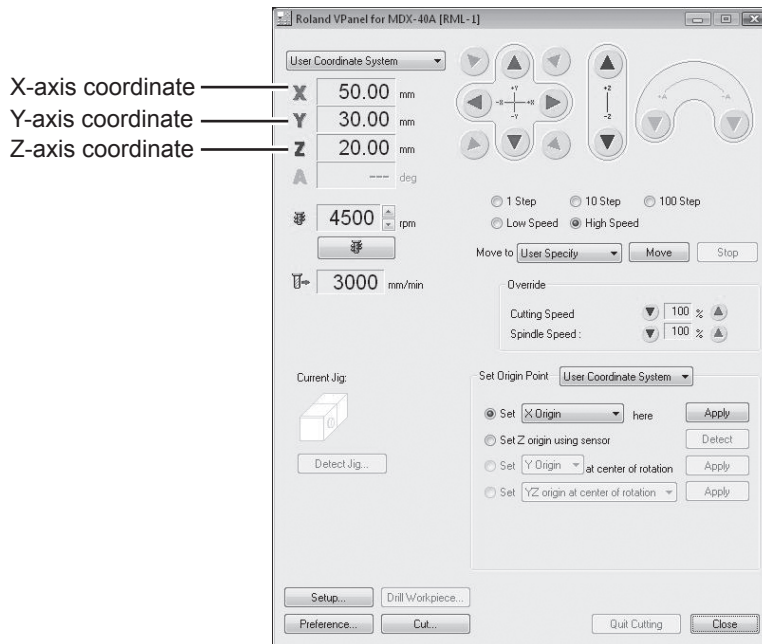
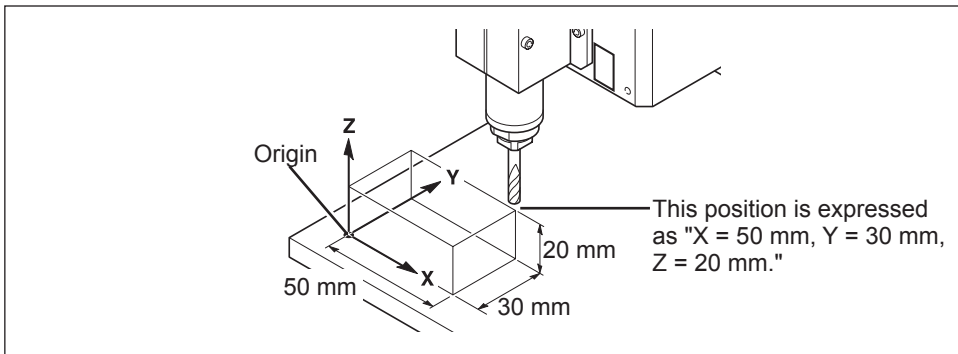

Selection of the Coordinate System

Select the coordinate system that is used to display the tool location in VPanel. The selection made here only determines the displaying method of coordinates. With the actual origin point, you need to perform the setting individually for the coordinate system that is used with the cutting data. When the command set is RML-1, it may be a good idea to leave the selection at "User Coordinate System" at all times. G54 to 59 and EXOFS can be selected only when "NC Code" or "Selected automatically (RML-1/ NC Code)" is selected for the command set.

- User Coordinate System: This is a coordinate system in which the location of the origin point can be freely changed.
- Machine Coordinate System: This is a machine-specific coordinate system in which the location of the origin point is fixed and cannot be changed.
- G54 to 59: This is a workpiece coordinate system for NC code. For the details, refer to "NC Code Reference Guide".
- EXOFS: This is used with the NC-code mode. For the details, refer to "NC Code Reference Guide."

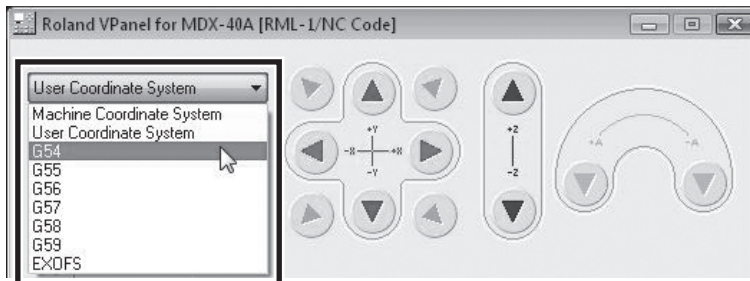

Changing the Unit of Measurement for Display

You can switch the unit of measurement used for displaying coordinates between millimeters and inches. Click the [Preference], then select the unit.

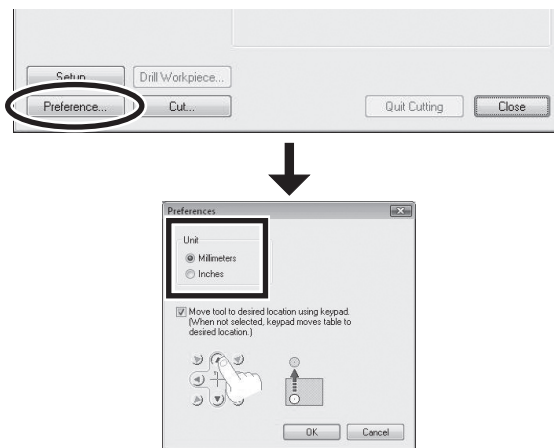

Moving to a Specific Position

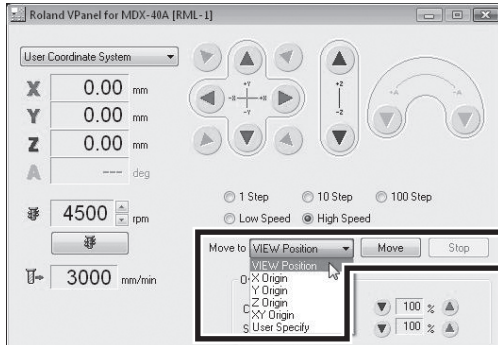

Selecting a destination from the list and clicking the [Move] button makes the tool move rapidly to the selected location. Clicking the [Stop] button stops movement.

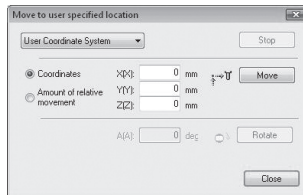

When "User Specify" Is Selected
Clicking the [Move] button makes the window shown at left appear. You can specify the location of the movement destination by entering the values you want for "Coordinates" or "Amount of relative movement."

Moving to the VIEW Position

Procedure

- 1 Close the front cover.

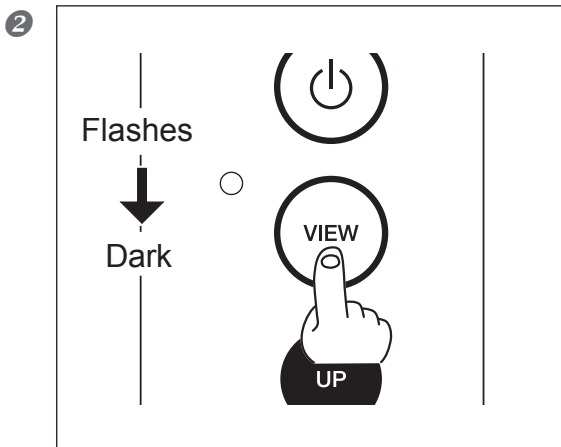

Press the VIEW button on the built-in panel at standby.

When the spindle head is moved up to the highest level, the table moves toward the front, and the spindle moves to the center of the machine. This location is called the "VIEW position." You use this when performing such operations as attaching or detaching a tool, installing a jig, or mounting a workpiece. The VIEW lamp flashes while movement is in progress. When the VIEW lamp goes dark, the movement is completed.

3-5 Starting and Stopping Spindle Rotation

Starting or Stopping the Spindle

Close the front covers and click .

The spindle begins to rotate.

Clicking  a second time stops the spindle rotation.

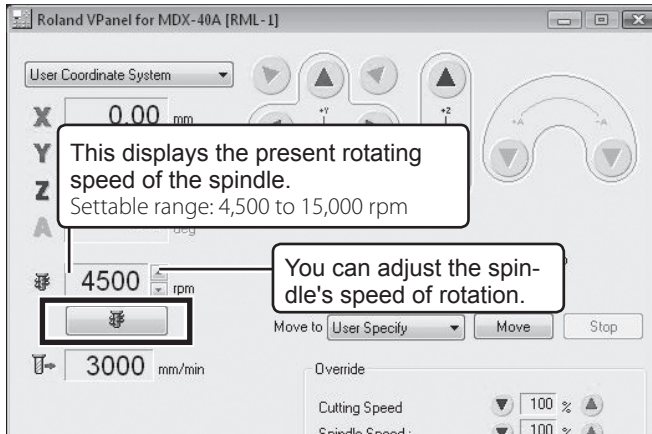

Setting the Spindle Speed During Cutting

The spindle's rotating speed during cutting operations is controlled by commands in the cutting data sent from the computer, and so the setting made in VPanel is ignored. Note, however, that the setting made with VPanel is used when the cutting data contains no command specifying the spindle speed, or if the setting is made again in VPanel while cutting is in progress. You can also use VPanel's override feature to adjust the speed of spindle rotation during cutting.

☞ P. 68, "Override"

3-6 Pausing/Resuming/Quitting of Cutting

Pausing and Resuming of Cutting by Operation of the Machine

This operation pauses cutting. You perform it using the built-in panel. This also makes it possible to resume cutting at the paused position after an operation such as moving the tool to check the status of the workpiece.

Procedure

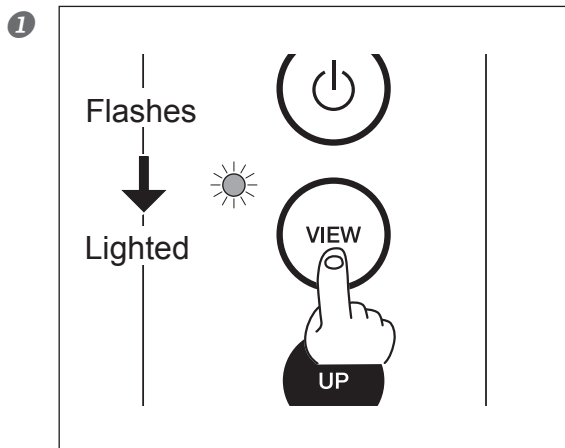

Press the VIEW button during cutting.

Rotation of the spindle stops, and the tool moves to the VIEW position. While movement of the tool and table is in progress, the VIEW lamp flashes, and after the movement is completed, the lamp lights up.

It is possible to open the front cover while the machine is paused. Before opening the front cover, make sure that the cutting operation stopped completely and that the VIEW lamp is lit.

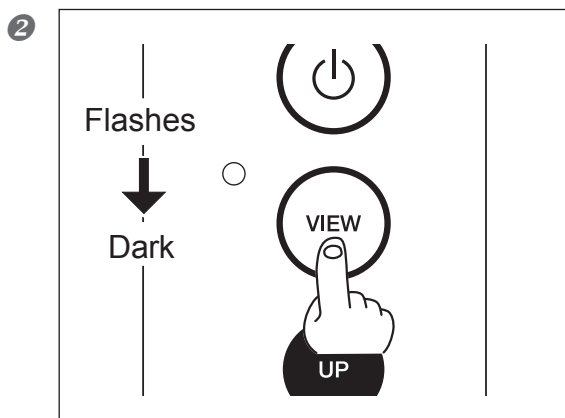

Press and hold the VIEW button.

The tool returns to the position where operation was paused, and cutting resumes. After the tool starts moving, the VIEW lamp flashes until cutting is resumed. When cutting is resumed, the VIEW lamp goes dark.

If you open the front cover while operation is paused, close the front cover, then perform the operation.

Other Operations Possible While Paused

VPanel

- Tool movement using manual feed
 - ☞ P. 48, "Manual Feed"
- Starting or stopping spindle rotation
 - ☞ P. 52, "Starting and Stopping Spindle Rotation"
- Changing the spindle speed
 - ☞ P. 68, "Override"
- Adjusting the tool feed rate
 - ☞ P. 68, "Override"

Quitting Cutting by Operation of the Machine

This stops cutting through operation using the built-in panel. Unlike pausing operation, cutting cannot be resumed.

Procedure

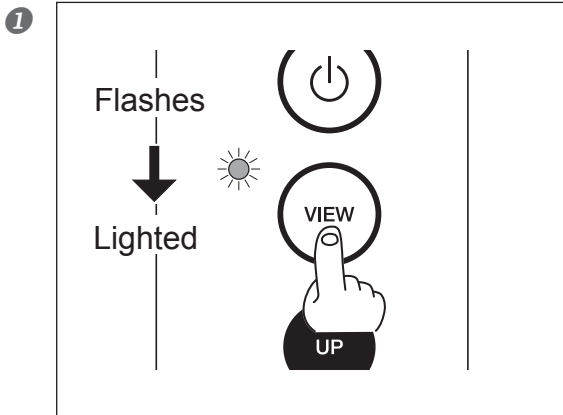

Press the VIEW button during cutting.

Rotation of the spindle stops, and the tool moves to the VIEW position. While movement of the tool and table is in progress, the VIEW lamp flashes, and after the movement is completed, the lamp lights up.

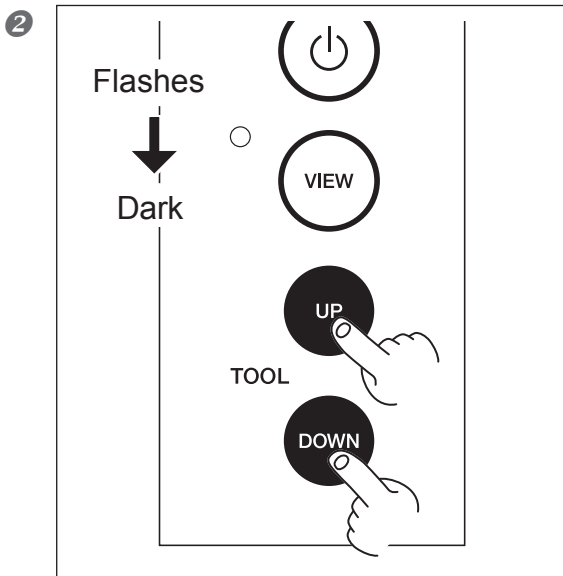

Until the VIEW lamp starts flashing, hold down both the TOOL-UP and TOOL-DOWN buttons.

Deletion of the data sent to the machine begins. When data deletion is completed, the VIEW lamp goes dark. This completes the quitting cutting operation.

Quitting Cutting by Operating from the VPanel

This stops cutting through operation using VPanel.

Procedure

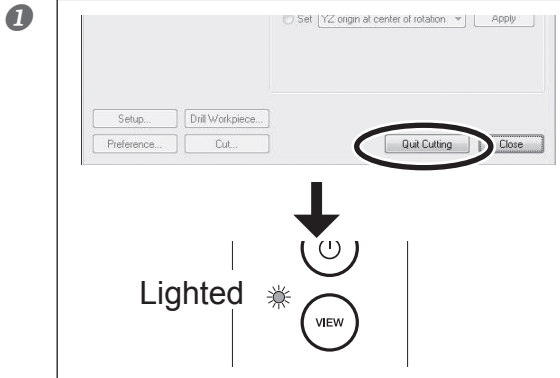

Click [Quit Cutting] during cutting.

The tool movement is stopped on the spot, and the VIEW lamp comes on. Rotation of the spindle does not stop at this time.

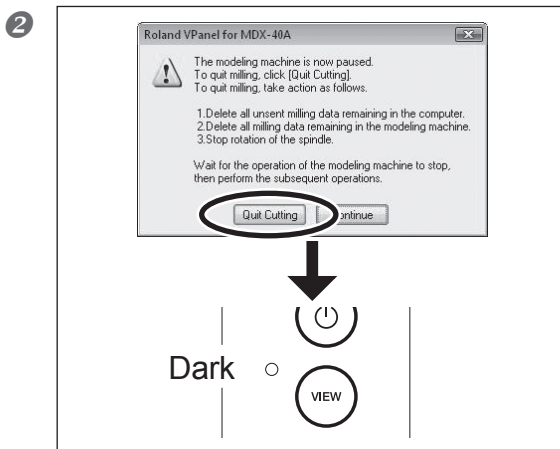

Confirm the message and click [Quit Cutting].

The spindle rotation stops, and the VIEW lamp goes dark. This completes the quitting of cutting operation.

Chapter 4

Getting Ready for and Performing Cut- ting

This section explains the preparations for cutting such as installing the tool and setting the reference position of the cutting, and the method for outputting the cutting data

4-1	Cutting Area	58
	Workpiece Size and Location Where Secured in Place	58
	Actual Size That Can Be Cut	58
4-2	Installing a Tool	59
	Tool Selection	59
	Features of the Tools	59
	Installing a Tool (End mill)	59
4-3	Starting Cutting	61
	About Origin Point	61
	Setting Origin Point	61
	Start Cutting (Output to the machine directly form the ap- plication)	64
	Start Cutting (Output via VPanel)	65
	Recovery of Operation from Emergency Stop or Emergency Shutdown	67
4-4	Override	68
	What's an Override?	68
	How to Make the Settings for Overrides	68

4-1 Cutting Area

Workpiece Size and Location Where Secured in Place

Arrange the workpiece (the material cut), frames, and the like so that they fit within the determined range. Anything extending beyond may strike moving parts. Be sure to observe this requirement, as failure to do so may result in damage to the workpiece or frame or malfunction of the machine.

 Cutting area

(Unit: mm)

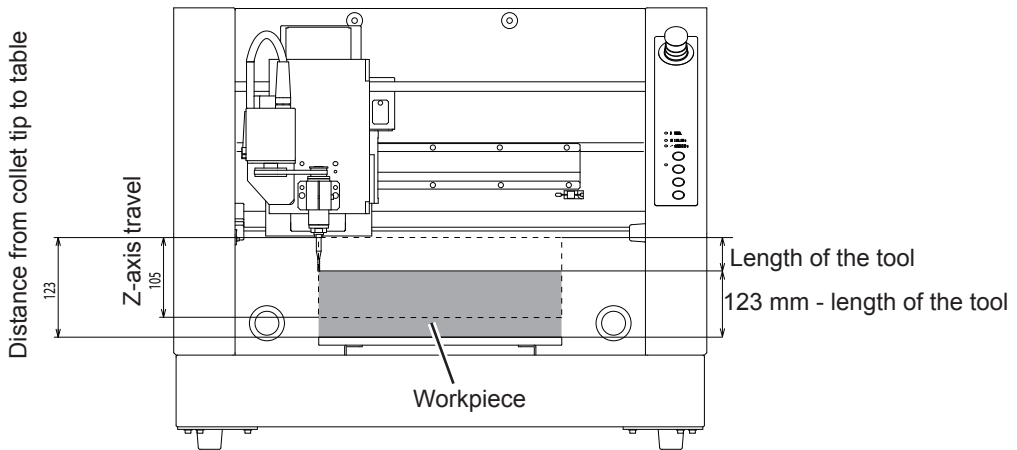
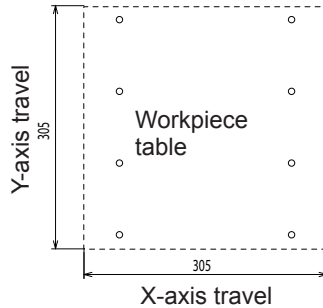

Actual Size That Can Be Cut

Creating an object of the size of the full axis travel is not necessarily possible. Because a certain amount of clearance in the X-, Y-, and Z-axes directions is required for no-load feed of the tool, the allowable size of the workpiece is reduced by a corresponding amount. Also, the possible cutting-in depth is generally determined by the length of the tool. Using a lengthy tool to achieve deep cutting reduces the clearance in the Z-axis direction, which further reduces the allowable size of the workpiece.

The size of what you can cut varies according to the shape of the object you want to create and the tool you use. Give careful thought to this ahead of time, before you start work.

4-2 Installing a Tool

Tool Selection

Select a tool matched to the purpose. It's a good idea to use the tools selectively, according to the work process (such as rough cutting or finish cutting) and the design.

Note: Tool is an optional part.

Features of the Tools

End mill

Straight end mill: The end cutting edge is flat-shaped. It is suitable for fashioning a flat surface or steps.

Ball end mill: The end cutting edge is ball-shaped. It is suitable for fashioning a curved surface or waveform.

Engraving cutter

Character cutter: This tool is suitable for engraving in general with broad versatility. It is appropriate for character engraving on the plate.

Parallel cutter: This cutter is suitable for engraving wide surfaces. This cutter enables engraving large characters and surface leveling (to flatten the surface of the material) of the table where the material is placed. Because both sides have a cutting blade, it is not possible to make a deep cut in the Z-axis direction.

Installing a Tool (End mill)

CAUTION

Do not touch the tip of the blade with your fingers.
Doing so may result in injury.

For the installation of engraving cutter, refer to  P. 73, "Installing the Engraving Cutter and Setting the Origin Point"

Procedure

①

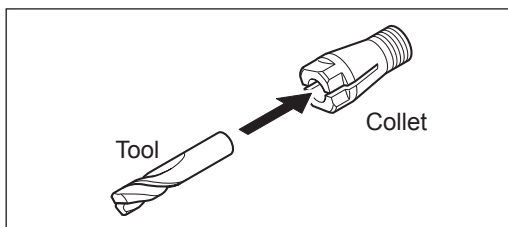

Insert the tool into the collet.

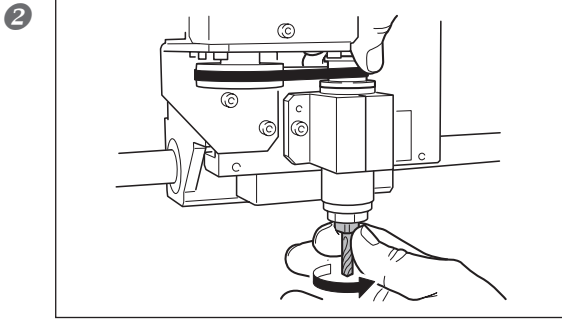

Loosely tighten the collet with tool.

While supporting the tool to keep it from falling, twist and lightly secure the collet.

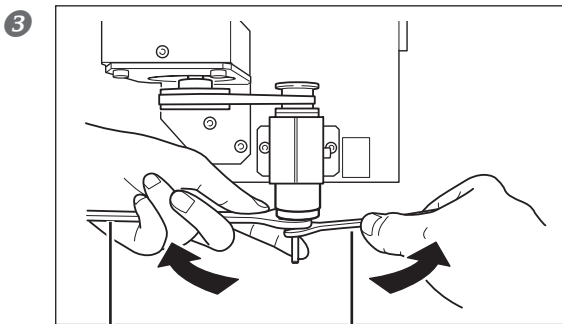

Fully tighten the collet.

While holding the tool with the fingers to keep it from falling, tightly secure the collet by using two spanners.

After installing the tool, set the reference position (Z and XY origin).

☞ P. 61, "Setting Origin Point"

Spanner (Large)

Spanner (Small)

4-3 Starting Cutting

About Origin Point

Before starting the cutting, you must set the origin point. When performing cutting with this machine, you need to set three origin points: the X, Y, and Z origins. Determine the X origin point and Y origin point based on the cutting data and workpiece location. You normally align the Z origin point with the surface of the workpiece. In any case, perform the settings to match the size of the workpiece and the length of the cutter.

Also, depending on the application software to be used, the location where the origin has to be set differs. Set the origin based on the specification of the application software to be used.

Setting Origin Point

1. Setting the Z origin.

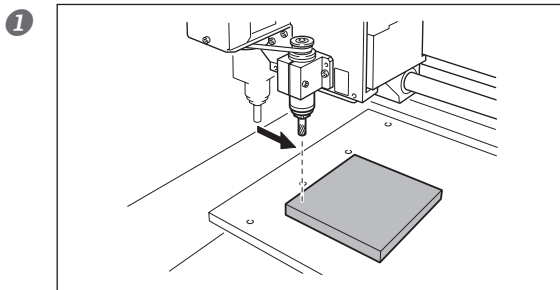

Move the tool to a location above the workpiece.

Next, perform a small amount of cutting into the workpiece. Move to a location where cutting will not cause any problems.

☞ P. 48, "Moving the Tool"

2 Close the front cover, then start the spindle rotation.

☞ P. 52, "Starting and Stopping Spindle Rotation"

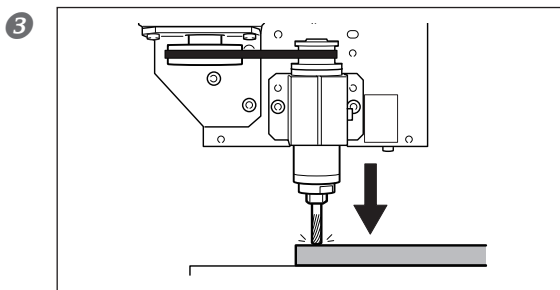

Lower the end mill to a location where the workpiece is cut by a slight amount.

☞ P. 48, "Moving the Tool"

- 4 **Stop the spindle rotation.**
 ☞ P. 52, "Starting and Stopping Spindle Rotation"

5 **For the RML-1 cutting data**

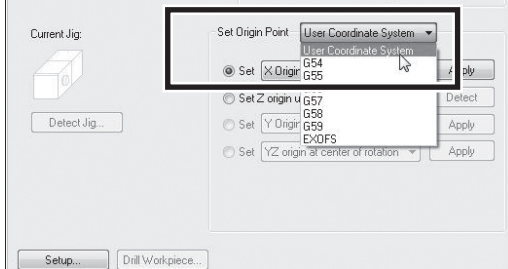

When "Selected automatically (RMX-1/NC Code)" is selected with the command set selection, choose "User Coordinate System" with Set Origin Point.

If "RML-1" is selected with the command set selection, only "User Coordinate System" is selectable with the Set Origin Point.

For the NC code cutting data

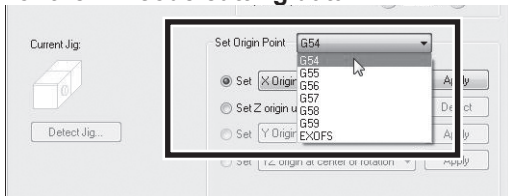

With "Set Origin Point", select the workpiece coordinate system that matches the cutting data.

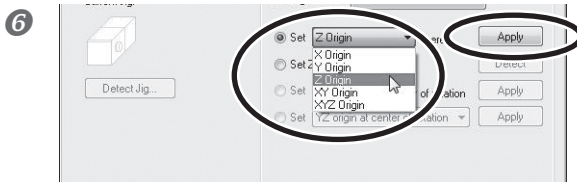

Select [Set "Z Origin" here], then click [Apply].

The Z origin has now been set.

7 **Raising the tool.**

Subsequently, perform movement along the X and Y directions. Raise the tool to a position where the tool does not come in contact with the workpiece.

☞ P. 48, "Moving the Tool"

2. Setting the XY origin.

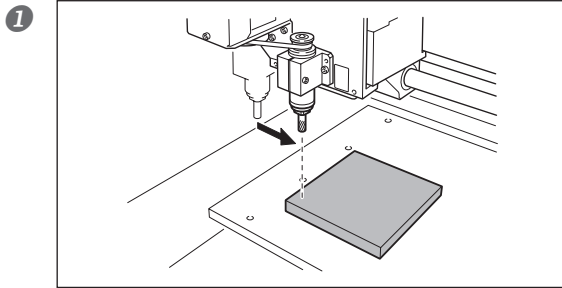

Move the tool to the location you want to make the XY origin point.

☞ P. 48, "Moving the Tool"

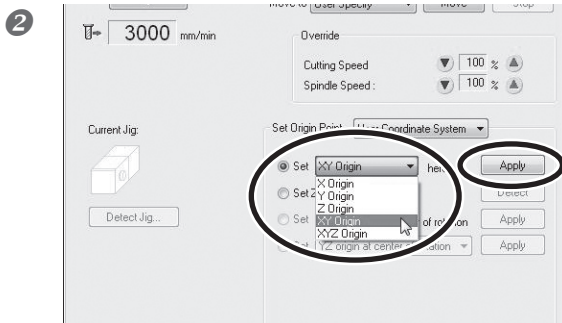

With "Set Origin Point", select the [Set "XY Origin" here], then click [Apply].

The XY origin has now been set.

Using the Axis Designation

In steps 1.-2 and 2.-2, you have selected "Z origin" or "XY origin", and performed the setting of origin point for each axis. Other than the above, the axis of origin point setting can be specified with this machine. For example, by selecting [XYZ Origin], all of the X, Y, and Z axes can be set at the same time. Also, selecting [X Origin] (or [Y Origin] or [Z Origin]) allows each axis to be set separately, and allows you to perform the setting of X only (or Y or Z only).

Origin Setting By Using Z0 Sensor

With this machine, you can also set the Z origin by using the Z0 sensor that comes with the machine. Refer to page 70 "Using the Z0 Sensor" for the details.

Start Cutting (Output to the machine directly form the application)

When the machine receives the cutting data from the computer, the spindle begins to rotate and cutting starts. The feed rate and the speed of spindle rotation are determined by the cutting data received.

Important !

Before starting the cutting, make sure of the following items. If there is a problem with any of these items, the machine may operate in an unintended manner, causing the workpiece to be wasted or the machine to be damaged.

- Whether the output file is correct.
- Whether the origin point is correct.
- Whether the cutting condition matches the workpiece type.

Procedure

1

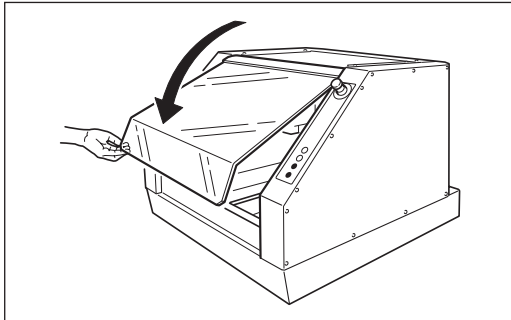

Close the front cover.

2

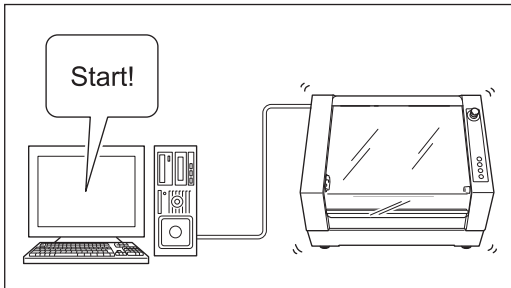

Use the software to output the cutting data.

Using the Output File List

In addition to sending cutting data directly from the software, you can take cutting data that has been made into a text file and import the file into VPanel.

☞ P. 65, "Start Cutting (output via VPanel)"

Start Cutting (Output via VPanel)

Overview of Operations

Step 1: Save the output file.

First, convert the program to a text file, then save it on the computer. This file is called the "output file."



Step 2: Register and execute the output file.

Add the saved output file to VPanel's output file list, then specify execution. You can register (add) multiple output files and execute them sequentially, one after another.

Starting Cutting

Important !

Before starting the cutting, make sure of the following items. If there is a problem with any of these items, the machine may operate in an unintended manner, causing the workpiece to be wasted or the machine to be damaged.

- Whether the output file is correct.
- Whether the origin point is correct.
- Whether the cutting condition matches the workpiece type.

Procedure

1

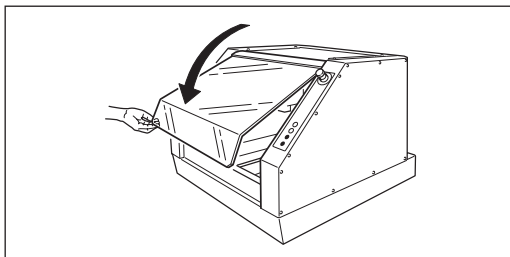

Close the front cover.

4-3 Starting Cutting



Click the [Cut] button on the VPanel.

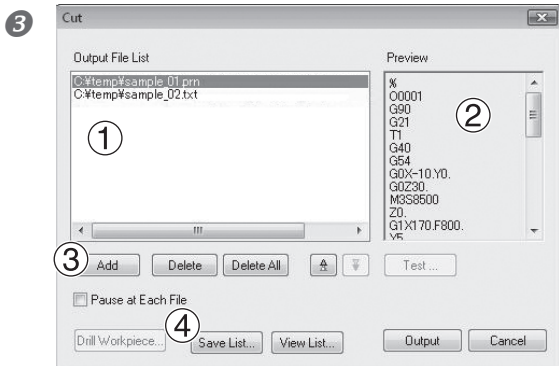

Click the [Add] button and open the output file. Alternatively, drag the output file to [Output File List].

① Output File List

This displays a list of registered output files. When two or more output files are present, they are executed sequentially, one after another. Click [Delete] button to delete the files.

② Preview

This displays the contents of the output file. (When the output file is in RML-1, files may not be displayed.)

③ [Add] Button

Clicking this displays a window for selecting the output file.

④ [Save List] Button

You can save the list of output files and output order as a list file.

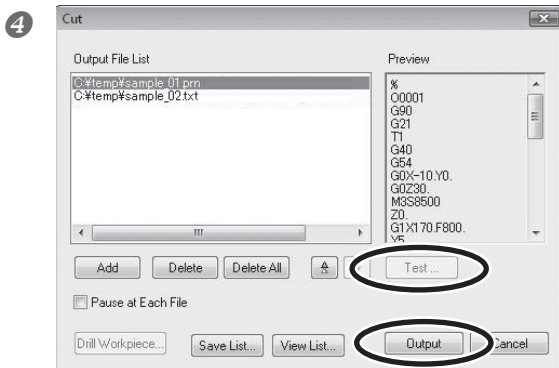

Click [Output].

Starts the cutting.

Clicking [Test] enables executing a program per line (only when the output file is in NC code).

Recovery of Operation from Emergency Stop or Emergency Shutdown

If an emergency stop or an emergency shutdown occurs during cutting, remove the tool and the workpiece from the machine. When the operation resumes, initialization is performed on the machine. At this time, the tool and the workpiece may collide depending on the position in which the tool and workpiece stopped, which can cause damage to the machine while restarting.

☞ P. 43, "Starting and Quitting"

4-4 Override

What's an Override?

Using Overrides

An override is a feature for adjusting the feed rate or spindle speed while cutting is in progress. This is useful when you want to change the feed rate or speed as you monitor the status of cutting.

An override value is specified as a percentage. For example, when the command in the cutting data sent from the computer is for a speed of 5,000 rpm, specifying an override of 150% produces an actual speed of 7,500 rpm.

Cutting Speed Override

This works on the tool movement speed of when the workpiece is being cut. The speed specified by the command in the cutting data is taken to be 100%.

Spindle Speed Override

This works on the rotation speed of the spindle. The speed specified by the command in the cutting data is taken to be 100%. This is also effective when rotating the spindle during manual operations.

How to Make the Settings for Overrides

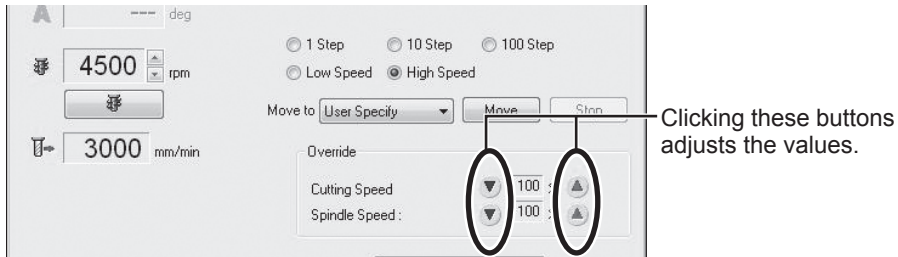

Important Notes on Overrides

Setting an override does not let you perform operation beyond the machine's maximum or minimum speeds.

Chapter 5

Appendix

This section explains how to use the engraving cutter as well as the maintenance method, countermeasures against the problems, and the specifications of the machine.

5-1 Using the Z0 Sensor	70
What's a Z0 Sensor	70
Setting the Z Origin Using the Z0 Sensor.....	70
Setting the Thickness of the Z0 Sensor.....	72
5-2 Using the Engraving Cutter.....	73
Installing the Engraving Cutter and Setting the Origin Point	73
5-3 Maintenance	76
Cleaning	76
Maintenance of the Spindle Unit.....	77
5-4 What to Do If.....	78
5-5 Responding to an Error Message	83
5-6 Power Rating and Serial Number Locations.....	86
5-7 NC Code Specifications.....	87
Word List	89
5-8 Specifications.....	91
Expansion Connector	91
External View.....	92
Dimensional Drawings of the Table Area.....	93
Main Specifications.....	94
System Requirements for USB Connection	95

5-1 Using the Z0 Sensor

What's a Z0 Sensor

This sensor is used for setting up the Z origin on the upper surface or others of the workpiece.

Important !

When using the machine, check that no cutting waste and the like is present on the tool and Z0 sensor. Otherwise, correct measurement may be impossible and the intended cutting results cannot be obtained.

Setting the Z Origin Using the Z0 Sensor

Important !

A tool that has an extremely narrow tip may break when it touches the tool sensor depending on which tool is to be used.

Procedure

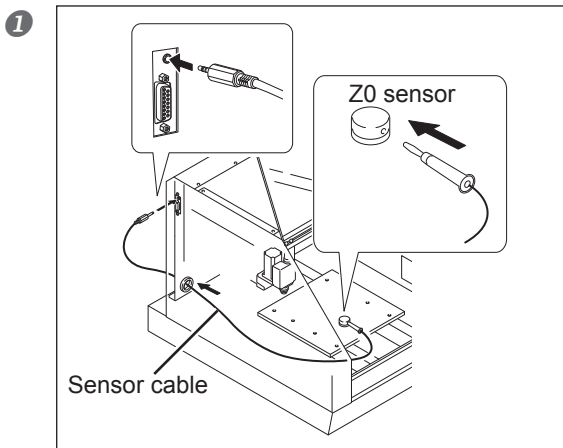

Connect the sensor cable.

If the sensor cable is detached from Z0 sensor, insert it.

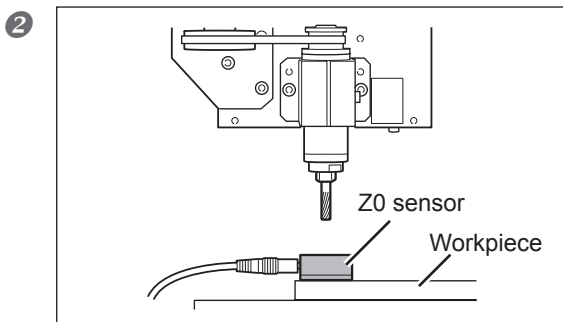

① **Set the workpiece on the table, and place the Z0 sensor at the place where an operator wants to set the Z origin on the workpiece.**

Face the surface of the Z0 sensor with no screw hole facing upward.

② **Use the VPanel feed button and move the tool to the position above the sensor.**

3 Close the front cover.

4 For the RML-1 cutting data

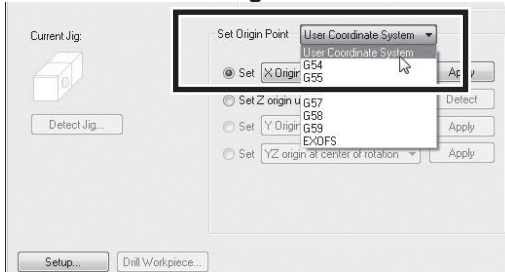

When "Selected automatically (RMX-1/NC Code)" is selected with the command set selection, choose "User Coordinate System" with Set Origin Point.

If "RML-1" is selected with the command set selection, only "User Coordinate System" is selectable with the Set Origin Point.

For the NC code cutting data

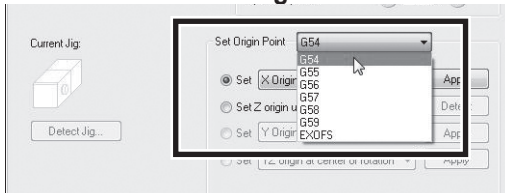

With "Set Origin Point", select the workpiece coordinate system that matches the cutting data.

5

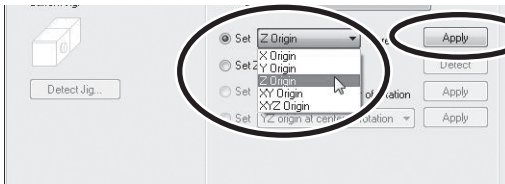

Select "Set "Z Origin" here", and click [Apply].

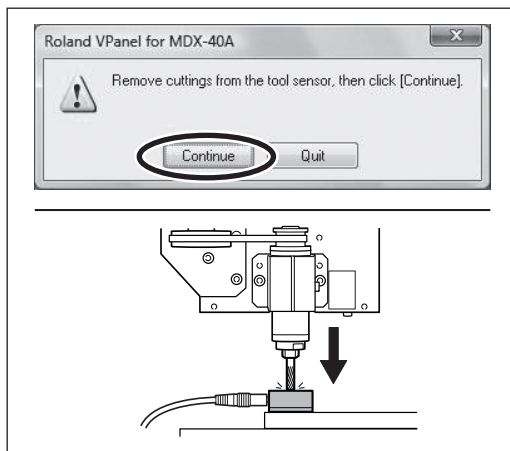

Click [Continue].

The tool slowly descend until it contacts the sensor.

When the tool rises and stops, the setting operation is complete.

Setting the Thickness of the Z0 Sensor

In order to improve the accuracy of the tool sensor, register the thickness of the tool sensor on the VPanel.

Procedure

1

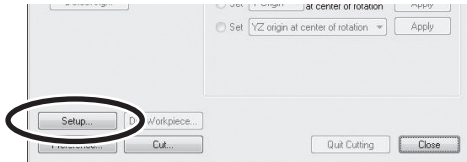

In VPanel, click the [Setup] button.

2

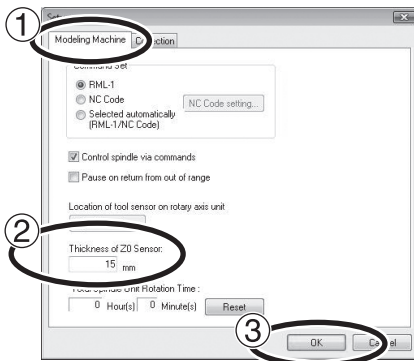

1 Click the [Modeling Machine] tab.

2 Input the thickness to [Thickness of Z0 Sensor].

3 Click [OK].

5-2 Using the Engraving Cutter

Installing the Engraving Cutter and Setting the Origin Point

The engraving cutter and collet come as the optional parts. Use a collet that matches the diameter of the cutter.

1. Installing the engraving cutter.

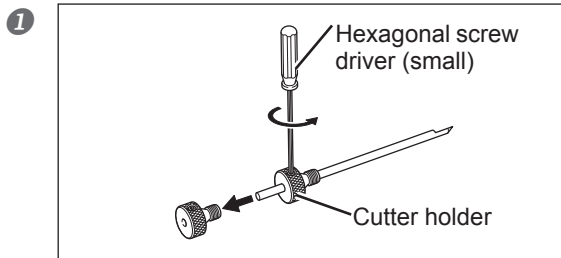

Detach the cutter holder from the cutter.

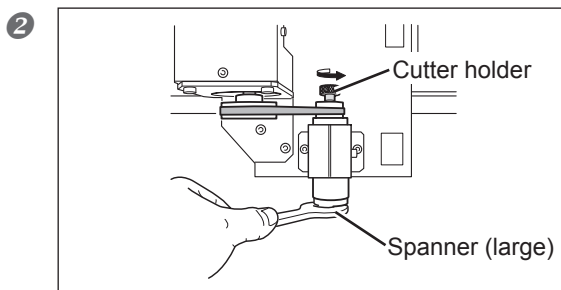

While holding the spindle unit immobile with a large spanner, tighten the cutter holder.

The cutter holder is reverse-threaded (that is, you turn it counterclockwise to tighten it). Be careful to turn it in the correct direction.

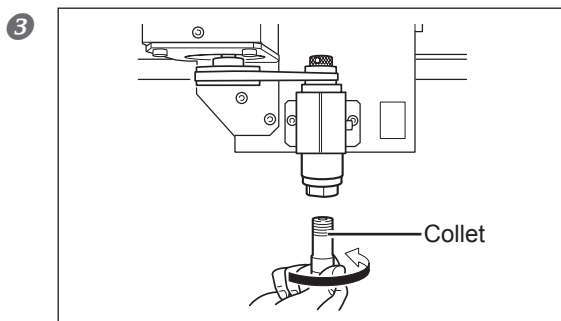

Insert the collet into the spindle unit from below.

5-2 Using the Engraving Cutter

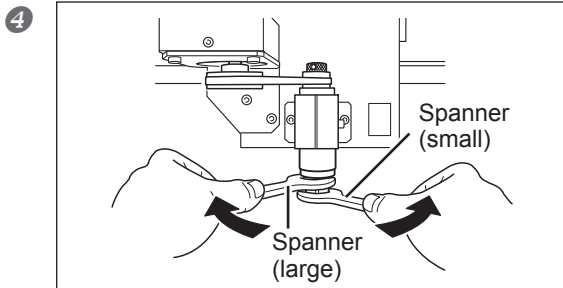

Using two Spanners, tighten the collet fully.

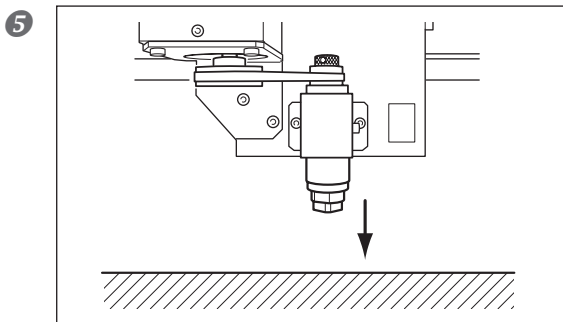

Lower the spindle and bring the tip of the collet close to the surface of the workpiece.

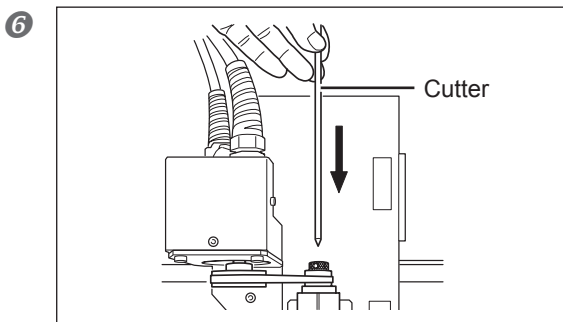

Insert the cutter.

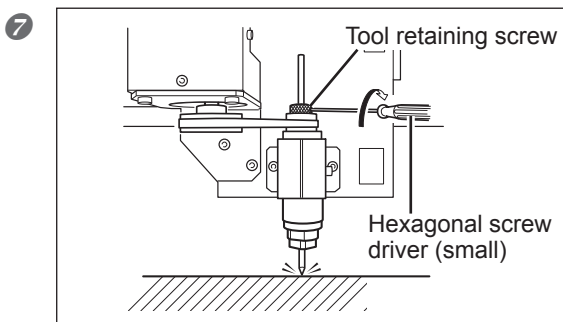

Making the tip of the cutter touch the surface of the workpiece, and tighten the tool retaining screw.

2. Make the settings for the Z, and XY origin point.

1 Close the front cover.

2 For the RML-1 cutting data

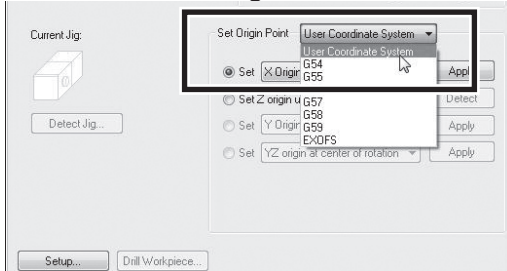

When "Selected automatically (RMX-1/NC Code)" is selected with the command set selection, choose "User Coordinate System" with Set Origin Point.

If "RML-1" is selected with the command set selection, only "User Coordinate System" is selectable with the Set Origin Point.

For the NC code cutting data

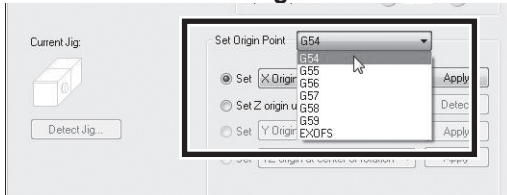

With "Set Origin Point", select the workpiece coordinate system that matches the cutting data.

3

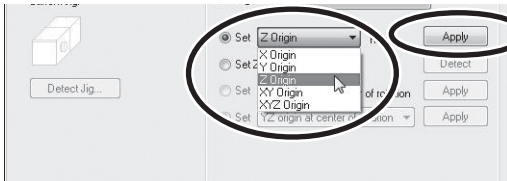

Select "Set Z Origin" here, and click [Apply].

The Z origin point has been set.

4 Raising the tool.

Subsequently, perform movement along the X and Y directions. Raise the tool to a position where the tool does not come in contact with the workpiece.

☞ P. 48, "Moving the Tool"

5 Move the cutter to the location you want to make the XY origin point.

☞ P. 48, "Moving the Tool"

6

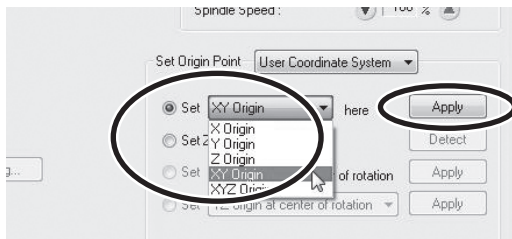

With "Set Origin Point", select the [Set "XY Origin" here], then click [Apply].

The XY origin has now been set.

5-3 Maintenance

Cleaning

⚠️ WARNING

Never use a pneumatic blower.

This machine is not compatible with a pneumatic blower. Cutting waste may get inside the machine and cause fire or electrical shock.

⚠️ WARNING

Never use a solvent such as gasoline, alcohol, or thinner to perform cleaning.

Doing so may cause fire.

⚠️ WARNING

Disconnect the power cord before performing cleaning or maintenance.

Attempting such operations while the machine is connected to a power source may result in injury or electrical shock.

⚠️ WARNING

When using a vacuum cleaner to take up cutting waste, exercise caution to prevent fire or dust explosion.

Taking up fine cuttings using an ordinary vacuum cleaner may cause danger of fire or explosion. Check with the manufacturer of the vacuum cleaner. When the safety of use cannot be determined, clean using a brush or the like, without using the vacuum cleaner.

⚠️ CAUTION

Caution: high temperatures.

The cutting tool and spindle motor become hot. Exercise caution to avoid fire or burns.

⚠️ CAUTION

When performing maintenance, be sure to keep the cutter detached.

Contact with the blade may cause injury.

- This machine is a precision device. Carry out daily care and maintenance.
- Carefully clean away cutting waste. Operating the machine with a large amount of cutting waste present may cause malfunction.
- Never apply silicone substances (oil, grease, spray, etc.) to the machine. Doing so may cause poor switch contact.
- Never apply lubrication.

Maintenance of the Spindle Unit

The spindle unit and the belt are parts that wear out. The replacement cycle varies according to usage conditions, but as a general guide, you should replace them after every 2,000 hours of use. You can use VPanel to view the total working time of the spindle. Refer to this to determine when replacement is needed. For information on how to perform replacement, refer to the documentation included with the ZS-40 replacement spindle.

As a general guide, replace the spindle motor after every 6,000 hours of use.

Checking the total working time of the spindle using VPanel

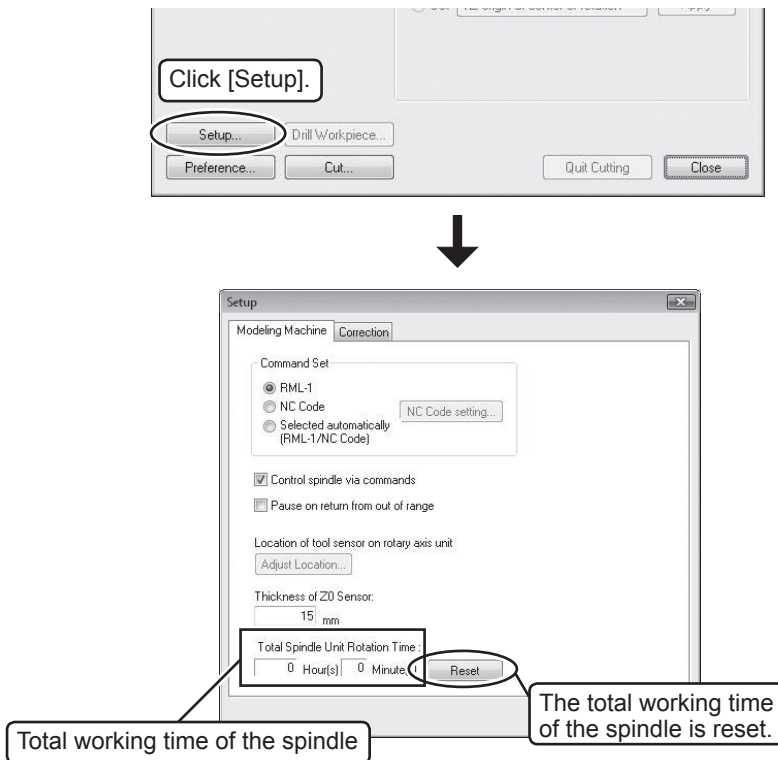

5-4 What to Do If...

The Power Does Not Come On.

Has the Emergency Stop button been pressed?

When the Emergency Stop button is pressed, the power does not come on. Release the Emergency Stop button.

☞ P. 42, "To Cancel an Emergency Stop"

Initialization is Not Performed or Initialization Fails.

Is a front cover open?

When starting the machine, close the front cover. For safety, initialization is not performed when a cover remains open at startup.

Is a large amount of cutting waste present?

Clean away any cutting waste. Clean the area around the spindle head especially carefully.

☞ P. 76, "Maintenance"

Is anything caught on the spindle head or table?

Check whether something has become caught and is impeding initialization.

VPanel Doesn't Start Correctly.

Has initialization been completed?

Before you start VPanel, first switch on the power to the machine.

☞ P. 43, "Starting and Quitting"

Is the computer connected?

Check whether the connector cable has come loose.

Is the driver installed correctly?

If the connection to the computer is not made in the sequence described, the driver may fail to be installed correctly. VPanel does not function normally when driver is misconfigured. Check again to ensure that the connection was made using the correct procedure.

☞ P. 38, "Installing the Windows-based Driver"

Are two or more machines connected to a single computer?

VPanel cannot control more than one machine at the same time. Never connect two or more instances of this machine to a single computer.

Operations are Ignored.

Is the cable connected?

Connect the cable securely.

☞ P. 34, "Cable Connections"

Was the machine started according to the correct procedure?

Simply switching on the main power does not enable operation. Start the machine using the correct procedure.

☞ P. 43, "Starting and Quitting"

Is a front cover open?

This machine restricts some operations when a front cover is open. Close the front cover.

Is the VIEW lamp on?

Press and hold the VIEW button to cancel the paused state.

Is the lamps flashing an error message?

☞ P. 80, "What to Do If a Flashing Error Is Displayed."

Is a large amount of cutting waste present?

Clean away any cutting waste. Clean the area around the spindle head especially carefully.

☞ P. 76, "Maintenance"

Is the driver installed correctly?

If the connection to the computer is not made in the sequence described, the driver may fail to be installed correctly. VPanel does not function normally when driver is misconfigured. Check again to ensure that the connection was made using the correct procedure.

☞ P. 38, "Installing the Windows-based Driver"

Are two or more machines connected to a single computer?

VPanel cannot control more than one machine at the same time. Never connect two or more instances of this machine to a single computer.

Is VPanel displaying an error message?

☞ P. 83, "Responding to an Error Message"

The Spindle Doesn't Rotate.

Is a front cover open?

For safety, the spindle does not rotate when a front cover is open. Close the front cover.

Is a large amount of cutting waste present?

Clear away any cutting waste. Clean the area around the spindle head especially carefully.

☞ P. 76, "Maintenance"

Has a setting been made to keep the spindle from rotating?

In VPanel, click the [Setup], then click the [Modeling Machine] tab. Here, select the [Control spindle via commands] check box.

Abnormal Cutting is Performed.

Is the location of the origin set correctly?

Check whether the origin has been set correctly. An incorrect origin location may result in cutting at an unintended position.

☞ P. 61, "About Origin Point," "Setting Origin Point,"

Is the command set correct?

Make sure the appropriate command set for the program you're using has been selected. An incorrect command mode may lead to errors, unintended operation, or no operation.

☞ P. 46, "Selecting the Command Set"

The Origin is Misaligned.

Is the correct workpiece coordinate system selected?

In the NC program, there are six coordinate systems. Depending on which coordinate system is used, the position of the origin differs. For instance, if the NC program uses G55, the origins must be set relative to workpiece coordinate system G55.

☞ P. 61, "Setting Origin Point," and "NC Code Reference Manual"

Has the EXOFS setting been made?

The EXOFS in the NC code have a function to shift the origin. Set EXOFS to zero, then redo the settings for the origins. If the origin is still shifted, check the program.

How to set EXOFS to zero:

1. Select [Machine Coordinate System] from the display of the coordinate system on the VPanel.
2. Move the tool position to "X: 0", "Y: 0", "Z: 0."
3. Select [EXOFS] at the [Setting Reference Point].
4. Select [Set "XYZ origin" here] from [Set Origin Point] and click [Apply].

☞ P. 46 "Selecting the Command Set," and p. 48, "Moving the Tool"

The Feed Rate or Spindle Speed is Wrong.

Has an override been set?

An override changes the feed rate or spindle rotation speed. Check the settings for overrides. Unless you have a special reason for changing them, leave all overrides set at 100%.

☞ P. 68, "Override"

The Cutting Results are Not Attractive.

Is the cutting condition optimal?

The optimal cutting parameters are determined by a balance of such factors as the hardness of the material, the feed rate, the spindle rotating speed, the cutting-in depth, and the capacity of the tool. Refer to the results and try fine tuning the parameters.

Is the tool firmly secured in place?

Retighten the collet to secure in place firmly.

☞ P. 59, "Installing a Tool," p. 73, "Installing the Engraving Cutter and Setting the Origin Point"

Is the tool tip worn?

If the tip of the tool is worn, replace with a new tool.

What to Do If a Flashing Error Is Displayed

If the lamps are flashing as shown below, then an error has occurred on the machine. To correct the error, follow the steps described below.

The MODELING and SCANNING lamps

An error occurred during initialization of the machine.

Switch the power off, then back on. If the error is not cleared when you switch the power on again, the machine may be malfunctioning. Contact your authorized Roland DG Corp. dealer.

The MODELING and VIEW lamps

A front cover was opened during cutting or spindle rotation.

Operation cannot be continued. Close the front cover and press the sub power button.

The MODELING lamp

The spindle motor error occurred.

Operation cannot be continued. Press the sub power button to clear the error. Make the program's cutting parameters more relaxed to lessen the load applied to the spindle.

Installation is Impossible

If installation quits partway through, or if the wizard does not appear when you make the connection with a USB cable, take action as follows.

Windows Vista

1. If the [Found New Hardware] appears, click [Cancel] to close it. Disconnect any USB cables for printers or other such equipment other than this machine.
2. Click the [Start] menu, then right-click [Computer]. Click [Properties].
3. Click [Device Manager]. The [User Account Control] appears, click [Continue]. The [Device Manager] appears.
4. At the [View] menu, click [Show hidden devices].
5. In the list, find [Printers] or [Other device], then double-click it. When the model name you are using or [Unknown device] appears below the item you selected, click it to choose it.
6. Go to the [Action] menu, and click [Uninstall].
7. In "Confirm Device Uninstall" window, select [Delete the driver software for this device.], then click [OK]. Close the [Device Manager].
8. Detach the USB cable connected to the printer, and the restart Windows.
9. Uninstall the driver. Carry out the steps from step 3 in page 81 "Uninstall the Driver Windows Vista" to uninstall the driver.
10. Install the driver again according to the procedure in page 38 "Installing the Windows-based Driver."

Windows XP

1. If the [Found New Hardware Wizard] appears, click [Finish] to close it. Disconnect any USB cables for printers or other such equipment other than this machine.
2. Click the [Start] menu, then right-click [My Computer]. Click [Properties].
3. Click the [Hardware] tab, then click [Device Manager]. The [Device Manager] appears.
4. At the [View] menu, click [Show hidden devices].
5. In the list, find [Printers] or [Other device], then double-click it. When the model name you are using or [Unknown device] appears below the item you selected, click it to choose it.
6. Go to the [Action] menu, and click [Uninstall].

7. In "Confirm Device Uninstall" window, click [OK].
8. Close the [Device Manager] and click [OK].
9. Detach the USB cable connected to the printer, and the restart Windows.
10. Uninstall the driver. Carry out the steps from step 3 in page 81 "Uninstall the Driver Windows XP" to uninstall the driver.
11. Install the driver again according to the procedure in page 38 "Installing the Windows-based Driver."

Uninstalling the Driver

When uninstalling the driver, perform following operation.

Windows Vista

1. Before you start uninstallation of the driver, unplug the USB cables from your computer.
2. Log on to Windows as "Administrators" right.
3. From the [Start] menu, click [Control Panel]. From the [Hard-ware and Sound] group, click [Printer]. [Printer] folder opens.
4. Click the model name's icon you are using. From the [Organize] menu, click [Delete]. The [User Account Control] appears, click [Continue].
5. A message prompting you to confirm deletion appears. Click [Yes].
6. In the [Printers] folder, right-click any location where no printer icon is present. From the [Run as administrator] menu, select [Server Properties]. The [User Account Control] appears, click [Continue].
7. Click the [Drivers] tab, then from the [Installed printer drivers] list, choose the machine to delete. Click [Remove].
8. The [Remove Driver And Package] appears, select [Remove driver and driver package]. Click [OK].
9. When the prompt message appears, click [Yes].
10. The package and driver to delete are displayed. Make sure that what is displayed is the machine you want to delete, then click [Delete].
11. The items that have been deleted are displayed. Click [OK].
12. Click [Close] on [Remove Driver And Package] window.
13. From the [Start] menu, choose [All Programs], then [Accessories], then [Run], and then click [Browse].
14. Choose the name of the drive or folder where the

driver is located. (*)

15. Select "SETUP.EXE" and click [Open], then click [OK].
16. The [User Account Control] appears, click [Allow].
17. The Setup program for the driver starts.
18. Click [Uninstall] to choose it. Select the machine to delete, then click [Start].
19. If it is necessary to restart your computer, a window prompting you to restart it appears. Click [Yes].
20. The uninstallation finishes after the computer restarts.

(*) When using the CD-ROM, specify the folder as shown below (assuming your CD-ROM drive is the D drive).

D:\Drivers\25D\WINVISTA

If you're not using the CD-ROM, go to the Roland DG Corp. website (<http://www.rolanddg.com/>) and download the driver for the machine you want to delete, then specify the folder where you want to expand the downloaded file.

Windows XP

1. Before you start uninstallation of the driver, unplug the USB cables from your computer.
2. Log on to Windows as "Administrators" right.
3. From the [Start] menu, click [Control Panel]. Click [Printers and Other Hardware], then click [Printers and Faxes].
4. Click the model name's icon you are using. From the [File] menu, choose [Delete].
5. A message prompting you to confirm deletion appears. Click [Yes].
6. Go to [File] and select [Server Properties].
7. Click the [Driver] tab, then from the [Installed printer drivers] list, choose the machine to delete.
8. Click [Delete]. When the prompt message appears, click [Yes].
9. From the [Start] menu, select [Run], then click [Browse].
10. From the [File Locations] list, choose the name of the drive or folder where the driver is located. (*)
11. Select "SETUP.EXE" and click [Open], then click [OK].
12. The Setup program for the driver starts.
13. Click [Uninstall] to choose it. Select the machine to delete, then click [Start].

5-4 What to Do If...

14. If it is necessary to restart your computer, a window prompting you to restart it appears. Click [Yes].

15. The uninstallation finishes after the computer restarts.

(*) When using the CD-ROM, specify the folder as shown below (assuming your CD-ROM drive is the D drive).

D:\Drivers\25D\WIN2KXP

If you're not using the CD-ROM, go to the Roland DG Corp. web-site (<http://www.rolanddg.com/>) and download the driver for the machine you want to delete, then specify the folder where you want to expand the downloaded file.

5-5 Responding to an Error Message

This section describes the error messages that may appear on the monitor of the computer you're using, and how to take action to remedy the problem. If the action described here does not correct the problem, or if an error message not described here appears, contact your authorized Roland DG Corp. dealer.

For Connection of Equipment

No response is returned from machine.
Make sure that the connection cable is connected securely and the machine is switched on.

Click [OK]. The machine may have accidentally been switched off, or the connector cable may have come loose. After checking, restart the machine.

☞ P. 43, "Starting and Quitting"

No modeling machine was found.
If the power is off, then switch it on.
If the cable is unconnected, then connect it.

Click [Quit], then restart the machine and redo the operation from the beginning.

☞ P. 43, "Starting and Quitting"

The sensor cable is not connected to the machine.

The error message appeared because the Z0 sensor was not connected when performing an operation that required the Z0 sensor. Click [OK]. Connect the Z0 sensor, and perform the operation again. If this message persists even after the Z0 sensor is connected, the error may be caused by a faulty connection or open circuit. In such cases, contact your authorized Roland DG Corp. dealer.

☞ P. 70, "Using the Z0 Sensor"

Detection Failure

The detection operation can not be started.

The detection operation was failed.

With the operation that uses the Z0 sensor, which utilizes flow of electricity, the detection operation failed because factors occurred that blocked the flow of electricity. Possible causes include the disconnection of Z0 sensor or dust of tool or Z0 sensor caused by cutting waste. If these parts are not free of dust, the sensor does not respond correctly. Clean away any dust first, and then perform the operation again. If detection still fails even after the connection is made or dust is cleaned, the failure may be caused by mechanical failures such as a cable disconnection. In such cases, contact your authorized Roland DG Corp. dealer.

☞ P. 43, "Starting and Quitting," p. 70, "Using the Z0 Sensor"

Pause

The MDX-40A is paused.
-- Command Error (name of command set)
Ignoring this error and continuing cutting is possible, but subsequent results are not assured.
Quitting cutting is strongly recommended.

If command does not match the machine's command set, select correct command set.

Operation was paused because a command error occurred. Click [Quit] to quit cutting. Cutting can be resumed by clicking [Continue], but doing so is very

likely to result in unintended operation and is not recommended.

The selection of command set may be incorrect. Make sure that the command set of cutting data and the command set selected in VPanel agree with each other. If the error occurs even when the selection of command set is correct, an unknown command may be contained in the cutting data. Check and correct the commands of cutting data.

When "Selected automatically (RML-1/NC Code)" is selected with the command set selection, the name of command set does not appear in the error message.

☞ P. 46, "Selecting the Command Set"

Emergency Stop

The MDX-40A has performed an emergency stop.

-- Cover opened during operation.

Operation cannot be continued.

To recover from an emergency stop, the power to the equipment must be reset. Carry out the following steps in the sequence shown.

- 1. Stop any output of cutting data from the CAM or other program.**
- 2. Switch the equipment off, then back on.**
- 3. Click the [OK] button for this message.**

An emergency stop occurred because a front cover was opened during cutting or spindle rotation. Follow the on-screen messages to switch off the power, close the front cover, and redo the operation from the beginning.

☞ P. 43, "Starting and Quitting"

The MDX-40A has performed an emergency stop.

-- (The message indicating the cause of the error)

Switch the equipment off, then back on.

If the symptom persists, a malfunction may have occurred.

Switch off the equipment's main power and contact your local vendor or Roland sales center.

An emergency stop occurred because of a failure in initialization or the like. The operation cannot be resumed immediately. The message indicating the cause of the error, as well as the causes of the emergency stop and the countermeasures are described below. If this message persists even after each of the countermeasures is implemented, turn the main power OFF, and contact your authorized Roland DG Corp. dealer.

***-Limit switch not found.**

An emergency stop occurred because initialization failed. Switch the power off, remove any cutting waste or other obstructions impeding operation of the spindle head, then redo the operation from the start.

*: "X," "Y," "Z," or "A" ("A" is indicated only when the optional ZCL-40A is connected.)

The NVRAM could not be accessed.

An emergency stop occurred because the machine's memory unit became partially inaccessible. Follow the on-screen messages to switch off the power and redo the operation from the beginning.

The spindle motor is not connected.

A communication error occurred in the spindle control firmware.

An unknown error occurred in the spindle control firmware.

An emergency stop occurred because of an error in spindle control. Follow the on-screen messages to

switch off the power and redo the operation from the beginning.

☞ P. 43, "Starting and Quitting"

The MDX-40A has performed an emergency stop.

-- (The message indicating the cause of the error)

Switch the equipment power off, then back on.

To prevent recurrence, revise the cutting parameters.

An emergency stop occurred because a spindle-motor error occurred. The operation cannot be resumed immediately. The message indicating the cause of the error, as well as the causes of the emergency stop and the countermeasures are described below.

The spindle motor experienced excessive current.

Spindle rotation is impossible because voltage is too low.

The Z motor experienced an excessive load.

This is caused by prolonged high load on the motor or by excessive torque being applied momentarily. Follow the on-screen messages to switch off the power. The cutting may have exceeded the capacity of the machine. Before restarting, revise the cutting conditions. Also, allow the machine to rest for some time, because the motor may have overheated. If messages like these persist, contact your authorized Roland DG Corp. dealer or Roland DG Corp.

☞ P. 43, "Starting and Quitting"

The MDX-40A has performed an emergency stop.

-- (The message indicating the cause of the error)

Switch the equipment power off.

Allow the equipment to rest for a while, then switch the power back on.

To prevent recurrence, revise the cutting parameters.

An emergency stop occurred because the machine experienced load that exceeded its capacity. The operation cannot be resumed immediately. The message indicating the cause of the error, as well as the causes of the emergency stop and the countermeasures are described below.

The spindle control circuit is running hot.

The spindle motor is running hot.

This is caused by prolonged high load on the motor or by excessive torque being applied momentarily. Follow the on-screen messages to switch off the power. The cutting may have exceeded the capacity of the machine. Before restarting, revise the cutting conditions. Also, allow the machine to rest for some time, because the motor may have overheated. If messages like these persist, contact your authorized Roland DG Corp. dealer.

☞ P. 43, "Starting and Quitting"

5-6 Power Rating and Serial Number Locations

Serial Number

This is required when you seek maintenance, servicing, or support. Never peel off the label or let it get dirty.

Power Rating

Use an electrical outlet that meets the requirements for voltage, frequency, and amperage given here.

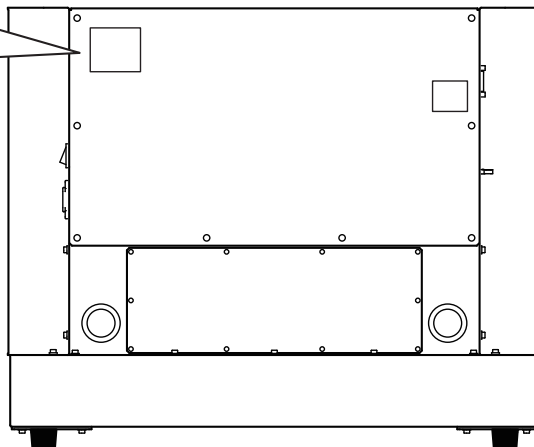

5-7 NC Code Specifications

Settings for NC Codes

This section groups together the settings involving the interpretation and execution of NC codes that you can manipulate on the machine. For others, use NC programs.

☞ "NC Code Reference Manual"

Note: In order to make the setting related to NC code, select [NC Code] or [Selected automatically (RML-1/NC Code)] for command set.

☞ P. 46, "Selecting the Command Set"

Value interpretation method

This selects the method of interpretation for numerical values containing a decimal point and the range for calculator- method interpretation.

In VPanel, click [Setup] button, and click [NC Code setting], and display the [NC Code] tab, then make the settings.

Workpiece origin offset (G54 through G59)

This setting affects the location of the workpiece coordinate origin. Select the objective Coordinate System from [Set Origin Point] on the VPanel and set the reference point. Note that making the setting in an NC program by using G10 or G92 is also possible.

EXOFS

Follow the setting method described below.

1. Set the display of the coordinate system on the VPanel to [Machine Coordinate System].
2. Specify the coordinate values of X, Y, and Z, respectively from the dialog, [Move to user specified location]
3. Select [EXOFS] at the [Set Origin Point].
4. Select [Set "XYZ origin" here] in the VPanel and click the [Apply].

Note that making the setting in an NC program by using G10 is also possible.

Tool-diameter offset value

In VPanel, click [Setup] button, and click [NC Code setting], and display the [Tool-diameter Offset] tab, then make the settings. Note that making the setting in an NC program by using G10 is also possible.

Tool-diameter offset type (G41 and G42)

This selects type A or type B. In VPanel, click [Setup] button, and click [NC Code setting], and display the [NC Code] tab, then make the settings.

Optional block skip (I) This setting enables or disables optional block skip. In VPanel, click [Setup] button, and click [NC Code setting], and display the [NC Code] tab, then make the settings.

Overrides

Feed speed (F), Main axis rotation speed (S) can be set. Make the settings in VPanel's main window.

Items Related to the Mechanical Specifications

This section describes the NC codes that are dependent on the machine's mechanical specifications.

☞ "NC Code Reference Manual"

Dimension word

Of dimension words X, Y, Z, and A, only X, Y, and Z are supported under the standard configuration. A is supported when a rotary axis unit is installed.

Data setting (G10)

The parameter range for G10 is as follows.

Parameter: number

Function: Offset number

Acceptable range: 1 to 8

Effective range: 1 to 8

Parameter: radius

Function: Tool-diameter offset value

Acceptable range: Range 1

Effective range: 0 to 10 mm (0 to 0.3937 inch)

Tool-diameter offset (G41 and G42)

The parameter ranges for G41 and G42 are as follows.

Parameter: number

Function: Offset number

Acceptable range: 0 to 8

Effective range: 0 to 8

Spindle speed (S)

When the standard spindle is installed, the parameter range for S is as follows.

Parameter: revolution speed

Function: Spindle speed

Acceptable range: Range 2

Effective range:

4500 to 15000 (Specified as rpm)

73 to 84 (Numerical-code specification)

Feed rate (F)

The parameter range for F is as follows.

Parameter: feed rate

Function: Feed rate

Acceptable range: Range 1

Effective range:

XY-axis: 7 to 3000 mm/min (0.28 to 118 inch/mm)

Z-axis: 7 to 1800 mm/min (0.28 to 70.8 inch/mm)

Note: The feed rate for the A axis is dependent on the specifications of the rotary axis unit installed. For more information, refer to the documentation for the rotary axis unit.

Interpretation of Omitted NC Codes

When the format for NC codes is abbreviated and one or more NC codes are omitted, the machine performs interpretation as described below. The method of interpretation is specific to the machine. When you want to make a program generic, needless omission should be avoided.

☞ "NC Code Reference Manual"

Measurement unit (G20 and G21)

When these are omitted, the interpretation is always for millimeter input (G21).

Tool-diameter offset (G41 and G42)

If these data are not written, the correction value that was set at the [Tool-diameter Offset] dialog on the VPanel is used.

Workpiece coordinate system (G54 through G59)

When these are omitted, the interpretation is always for workpiece coordinate system 1 (G54).

Dimension (G90 and G91)

When these are omitted, the interpretation is always for absolute specification (G90).

Feed rate (F)

When F is not stated, the feed rate is 120 mm/min.

Spindle speed (S)

When S is not stated, the speed set at VPanel's main window is used.

Word List

The words supported by this machine are listed in the following chart. Refer to “NC Code Reference Manual” to find the details of each word.

Preparatory Functions (G Functions)

Group name	Word	Function	Continued functioning
Positioning/ interpolation	G00	Positioning	Modal
	G01	Linear interpolation	
	G02	Clockwise circular interpolation	
	G03	Counterclockwise circular interpolation	
	G04	Dwell	One-shot
	G10	Data setting	One-shot
Plane selection	G17	Select X-Y plane	Modal
	G18	Select Z-X plane	
	G19	Select Y-Z plane	
Setting the mea- surement unit	G20	Inch input	Modal
	G21	Millimeter input	
	G28	Restore reference point	One-shot
	G39	Corner-offset circular interpolation	One-shot
Tool-diameter offset	G40	Cancel tool-diameter offset	Modal
	G41	Tool-diameter offset -- left	
	G42	Tool-diameter offset -- right	
	G53	Movement on machine coordinate system	One-shot
Workpiece coordi- nate systems	G54	Select workpiece coordinate system 1	Modal
	G55	Select workpiece coordinate system 2	
	G56	Select workpiece coordinate system 3	
	G57	Select workpiece coordinate system 4	
	G58	Select workpiece coordinate system 5	
	G59	Select workpiece coordinate system 6	
Fixed cycle	G80	Cancel fixed cycle	Modal
	G81	Fixed cycle	
	G82	Fixed cycle	
	G83	Fixed cycle	
	G85	Fixed cycle	
	G86	Fixed cycle	
	G89	Fixed cycle	
Dimension	G90	Absolute	Modal
	G91	Incremental	
	G92	Set coordinate system	
Return point	G98	Initial level return	Modal
	G99	Point R level return	

Miscellaneous Functions (M Functions), Feed Function (F Function), and Spindle Speed Function (S Function)

Word	Function	Function start		Function continuation	
		Simultaneously with operation specified in the same block	After ending of operation specified in the same block	Sustained until canceled or changed	Effective only within the block in which specified
M02	End of program	✓			✓
M03	Rotate spindle	✓		✓	
M05	Stop spindle	✓		✓	
M30	End of program	✓			✓
F	Feed rate	✓		✓	
S	Spindle speed	✓		✓	

Other Functions

Word	Function
A	Dimension word
I	Dimension word
J	Dimension word
K	Dimension word
N	Sequence number
O	Program number
R	Dimension word
X	Dimension word
Y	Dimension word
Z	Dimension word
/	Optional block skip
%	Data start / Data end
<EOB>	End of block
()	Comment

5-8 Specifications

Expansion Connector

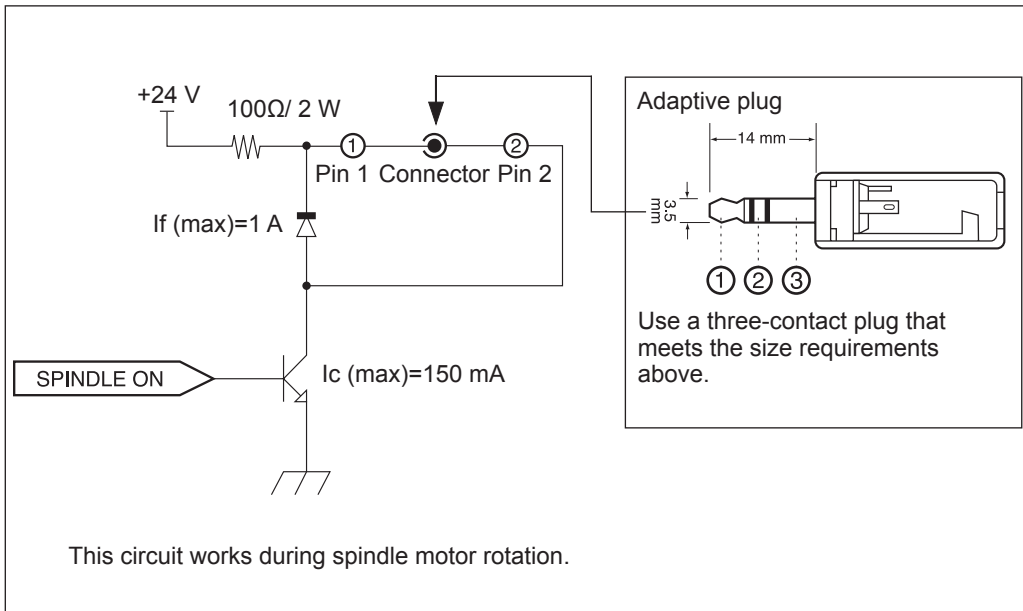

Expansion connector

- Be sure to use the connector within the rated range shown above.
- Do not apply voltage greater than 24 V to the terminal.
- Do not short-circuit the connector and earthing.

Adaptive plug

- Do not use terminal ③. Use only terminals ① and ②.

No responsible is assumed for effects to which any equipment connected to this external output connector is subjected.

No responsible is assumed for malfunction when using any equipment connected to this external output connector is subjected.

External View

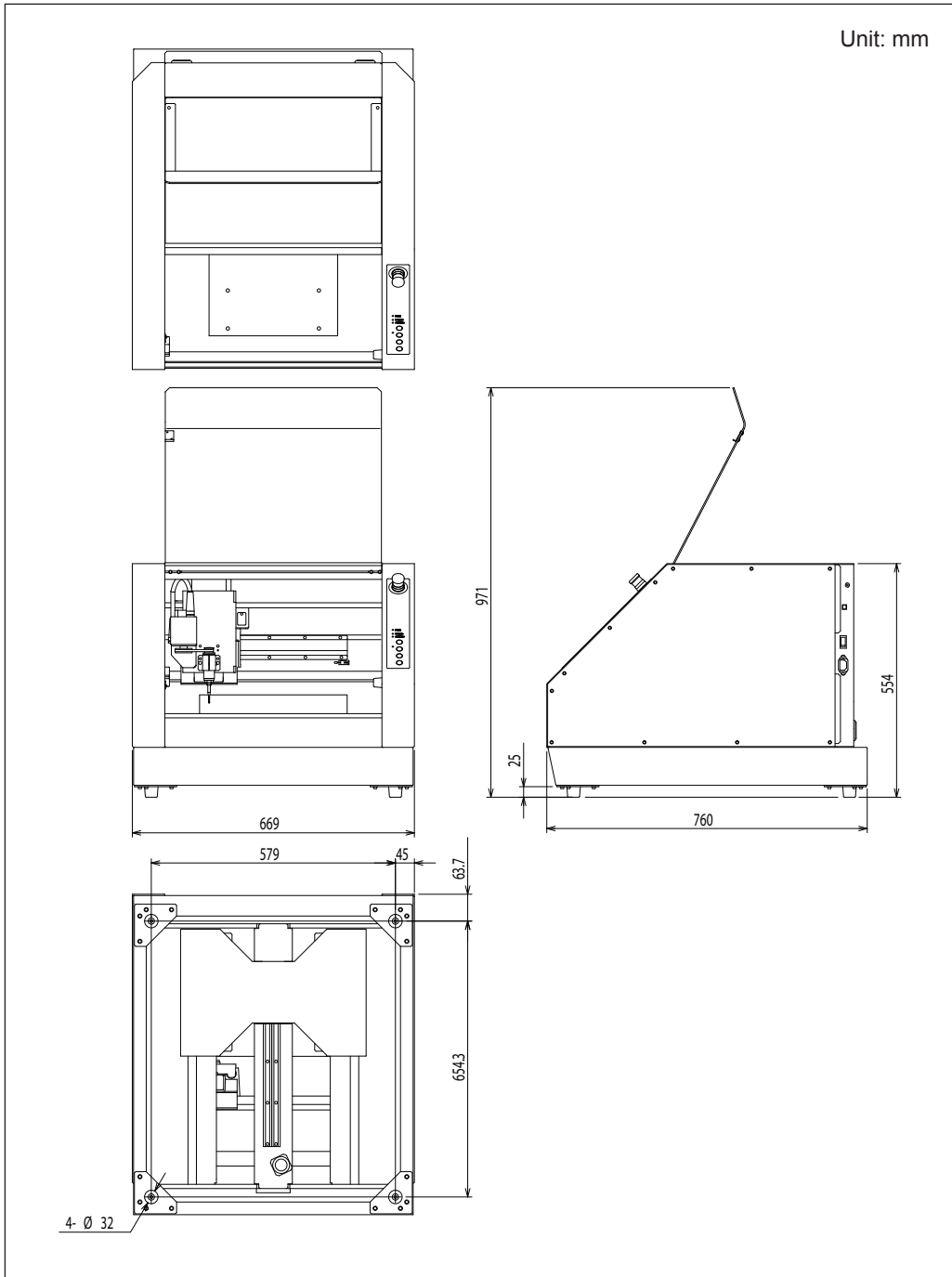

Dimensional Drawings of the Table Area

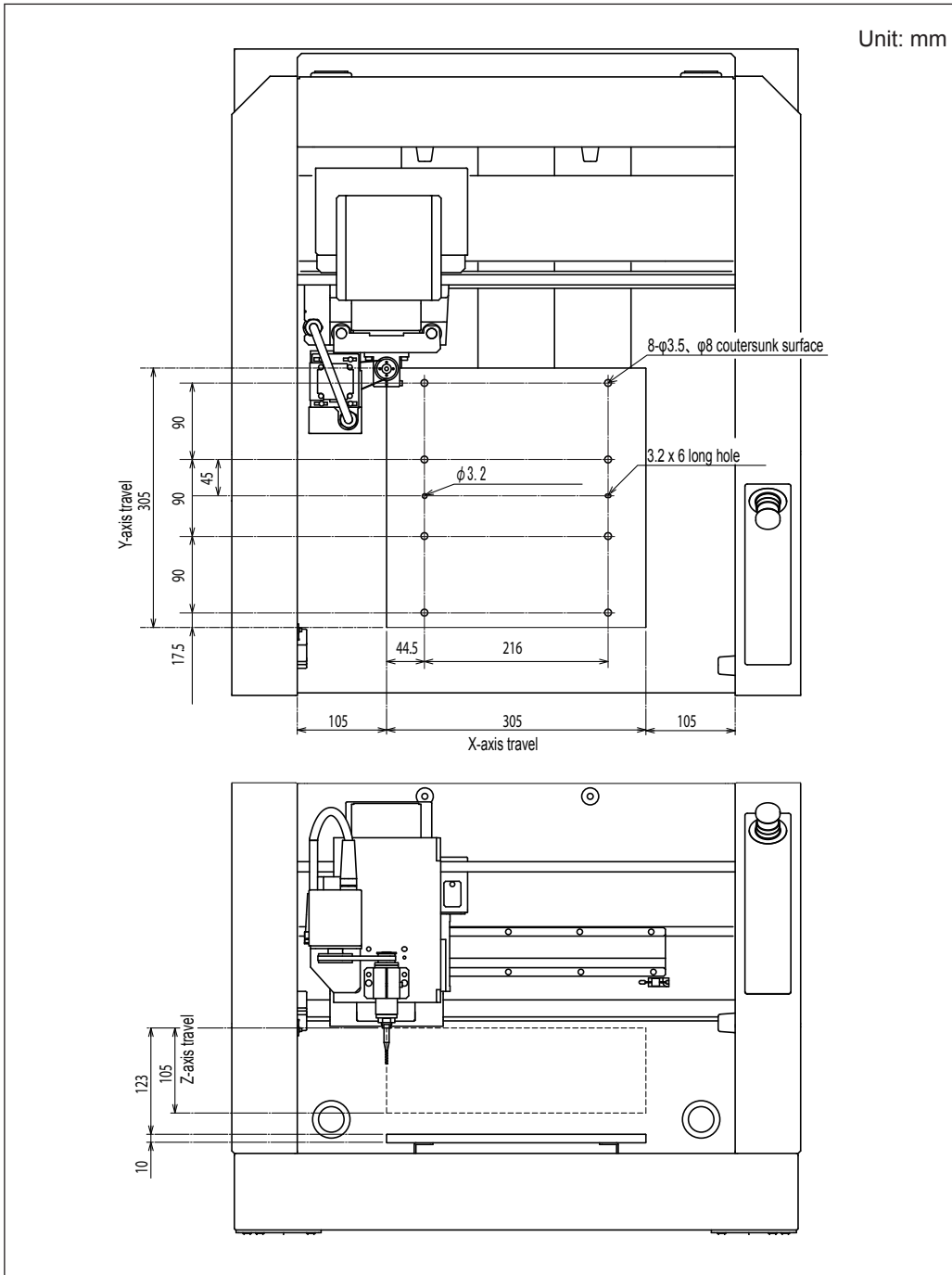

Main Specifications

	MDX-40A
Cutable material	Resins such as chemical wood and modeling wax (metal not supported)
X, Y, and Z operation strokes	X, Y, and Z: 305 x 305 x 105 mm (12 x 12 x 4.13 in.)
Distance from collet tip to table	Maximum 123 mm (4.84 in.)
Workpiece table size	Width x depth: 305 × 305 mm (12 x 12 in.)
Loadable workpiece weight	4 kg (8.8 lb)
X-, Y-, and Z-axis drive system	Stepping motor
Operating speed	XY-axis : 7 to 3000 mm/min. (0.28 to 118 in./m) Z-axis : 7 to 1800 mm/min. (0.28 to 70.8 in./m) * 2 mm/min step for 7 to 60 mm/min(0.28 to 2.36 in./m) * 60 mm/min step for 60 to 3000 mm/min(2.36 to 118 in./m).
Software resolution	0.01 mm/step (0.00039 in./step) (RML-1), 0.001 mm/step (0.000039 in./step) (NC code)
Mechanical resolution	0.002 mm/step (0.000078 in./step) (micro-step control)
Spindle motor	Brushless DC motor, maximum 100W
Spindle rotation	4,500 to 15,000 rpm
Tool chuck	Collet method
Interface	USB (compliant with Universal Serial Bus Specification Revision 1.1)
Control command sets	RML-1, NC code
Power requirements	Voltage and frequency: AC 100 to 240 V ±10%, 50/60 Hz (overvoltage category II, IEC 60664-1) Required power capacity: 2.1 A
Power consumption	Approx. 210 W
Operating noise	During operation: 56 dB (A) or less (when not cutting), during standby: 42 dB (A) or less
External dimensions	Width x depth x height : 669 x 760 x 554 mm (26.4 x 30 x 21.9 in.)
Weight	65 kg
Installation Environment	Operating environment: Temperature of 5 to 40°C (41 to 104 °F), 35 to 80% relative humidity (no condensation) Ambient pollution degree: 2 (as specified by IEC 60664-1)
Included items	Power cord, USB cable, collet , Z0 sensor, hexagonal screwdrivers, hexagonal wrench, spanners, User's Manual (this document), SRP Player Installation and Setup Guide, SRP Player CD-ROM, Roland Software Package CD-ROM

System Requirements for USB Connection

Computer	Model preinstalled with Windows Vista (32 bit) or XP, or upgraded computer originally preinstalled with Windows XP.
USB cable	Use the included USB cable.



100006178

R1-090609