

ZBX-650/500A

MDX-650/500 Safety Cover

USER'S MANUAL

ENGLISH



Page
1 to 12

Thank you very much for purchasing the safety cover.

- To ensure correct and safe usage with a full understanding of this product's performance, please be sure to read through this manual completely and store it in a safe location.
- Unauthorized copying or transferral, in whole or in part, of this manual is prohibited.
- The contents of this operation manual and the specifications of this product are subject to change without notice.
- The operation manual and the product have been prepared and tested as much as possible. If you find any misprint or error, please inform us.
- Roland DG Corp. assumes no responsibility for any direct or indirect loss or damage which may occur through use of this product, regardless of any failure to perform on the part of this product.
- Roland DG Corp. assumes no responsibility for any direct or indirect loss or damage which may occur with respect to any article made using this product.

This user's manual is a bilingual document for English-speaking users and Japanese-speaking users of the ZBX-650/500A.



ROLAND DG CORPORATION

1-6-4 Shimmiyakoda, Hamamatsu-shi, Shizuoka-ken, JAPAN 431-2103

MODEL NAME : See the MODEL given on the rating plate.

RELEVANT DIRECTIVE : **EC MACHINERY DIRECTIVE (98/37/EC)**

EC LOW VOLTAGE DIRECTIVE (73/23/EEC)

EC ELECTROMAGNETIC COMPATIBILITY DIRECTIVE (89/336/EEC)

WARNING

This is a Class A product. In a domestic environment this product may cause radio interference in which case the user may be required to take adequate measures.



Table of Contents

To Ensure Safe Use	2
About the Affixed Labels	5
About This Manual	7
1 Names of Parts	7
2 Setting Up	8
3 Connection	9
4 Spindle Action	10
5 Use and Handling of the Cover	11
Opening and Closing the ZBX-650 Door	11
Removing the Cover for Maintenance	12
Specifications	12



Copyright © 2001 Roland DG Corporation

To Ensure Safe Use

About ⚠ WARNING and ⚠ CAUTION Notices

 WARNING	Used for instructions intended to alert the user to the risk of death or severe injury should the unit be used improperly.
 CAUTION	Used for instructions intended to alert the user to the risk of injury or material damage should the unit be used improperly. * Material damage refers to damage or other adverse effects caused with respect to the home and all its furnishings, as well to domestic animals or pets.

About the Symbols

	The ⚠ symbol alerts the user to important instructions or warnings. The specific meaning of the symbol is determined by the design contained within the triangle. The symbol at left means "danger of electrocution."
	The ⚡ symbol alerts the user to items that must never be carried out (are forbidden). The specific thing that must not be done is indicated by the design contained within the circle. The symbol at left means the unit must never be disassembled.
	The ● symbol alerts the user to things that must be carried out. The specific thing that must be done is indicated by the design contained within the circle. The symbol at left means the power-cord plug must be unplugged from the outlet.

⚠ WARNING



Do not disassemble, repair, or modify.

Doing so may lead to fire or abnormal operation resulting in injury.



Do not use with any electrical power supply that does not meet the ratings displayed on the unit.

Use with any other power supply may lead to fire or electrocution.



Ground the unit with the ground wire.

Failure to do so may result in risk of electrical shock in the even of a mechanical problem



Do not use while in an abnormal state (i.e., emitting smoke, burning odor, unusual noise, or the like).

Doing so may result in fire or electrical shock.

Immediately switch off the power, unplug the power cord from the electrical outlet, and contact your authorized Roland DG Corp. dealer or service center.



Use only with the power cord included with this product.

Use with other than the included power cord may lead to fire or electrocution.

⚠ CAUTION



Do not use with a damaged power cord or plug, or with a loose electrical outlet.

Use with any other power supply may lead to fire or electrocution.

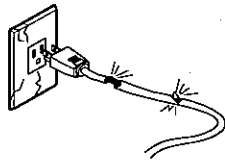

When not in use for extended periods, unplug the power cord from the electrical outlet.

Failure to do so may result in danger of shock, electrocution, or fire due to deterioration of the electrical insulation.

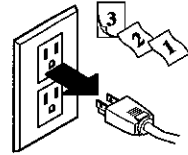

Do not injure or modify the electrical power cord, nor subject it to excessive bends, twists, pulls, binding, or pinching, nor place any object of weight on it.

Doing so may damage the electrical power cord, leading to electrocution or fire.

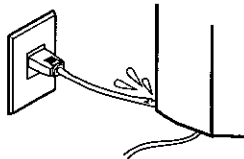

When unplugging the electrical power cord from the power outlet, grasp the plug, not the cord.

Unplugging by pulling the cord may damage it, leading to fire or electrocution.

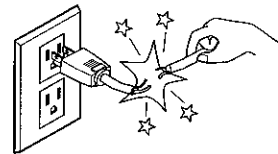

Do not attempt to unplug the power cord with wet hands.

Doing so may result in electrical shock.

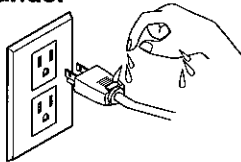

Do not connect the power cord with other electrical loads on a single electrical outlet.

Doing so may generate heat and cause fire.



Unpacking, installation, and moving are operations that must be carried out by five or more persons for the MDX-650 and by four or more persons for the MDX-500.

Failure to do so may result in falling of the unit, leading to injury.

(The MDX-650 weighs 120 kg (264.5 lb.), and the MDX-500 weighs 92 kg (202.8 lb.).)

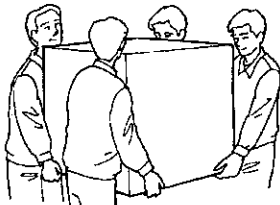

When opening or closing the safety cover, grasp the handle with both hands.

The fingers may be pinched, resulting in injury.

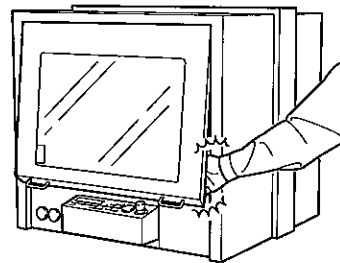

Install on a stable surface.

Failure to do so may result in falling of the unit, leading to injury.

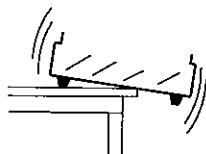

Do not attempt to move with the MDX-650/500 inserted into the safety cover.

Breakage of the cover may cause the MDX-650/500 to fall, resulting in injury.

⚠ CAUTION



Do not use the safety cover if it is cracked.

If you find a crack, contact your authorized Roland DG Corp. dealer or service center immediately.

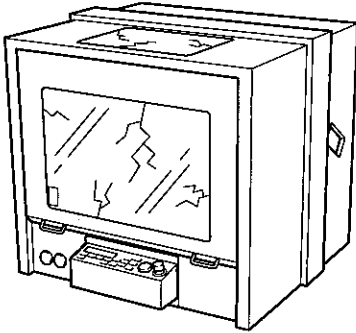

If you are using the safety cover, detach the key connector from the MDX-650/500.

Unintended operation may cause injury.



Do not touch the tip of the blade with your fingers.

Doing so may result in injury.



Do not insert your fingers between the T-slot table and the arm or between the heads and the Z-axis cover.

The fingers may be pinched, resulting in injury.

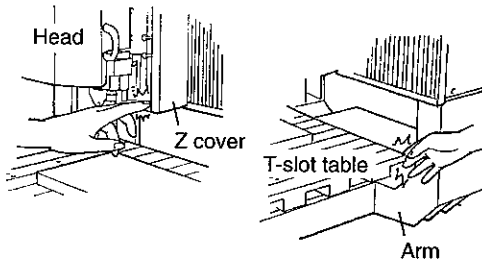

If operation continues even after you open the safety cover, wait until operation stops.

Doing so may result in injury.



Perform dry cutting with no cutting oil.

Such materials can cause fire.

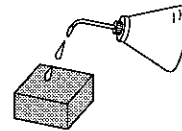

Do not touch the tool immediately after cutting operating stops.

The tool may have become hot due to friction heat and may cause burns if touched.



Switch off the machine and unplug the power cord from the electrical outlet before performing cleaning or maintenance.

Failure to do so may result in injury or electrical shock.



Please use a vacuum cleaner to remove cutting dust. Do not use any blower like airbrush. Otherwise, dust spread in the air may harm your health.



When you're finished, wash your hands to rinse away all cuttings.



About the Affixed Labels

The following labels are affixed.
The following figure describes the location.

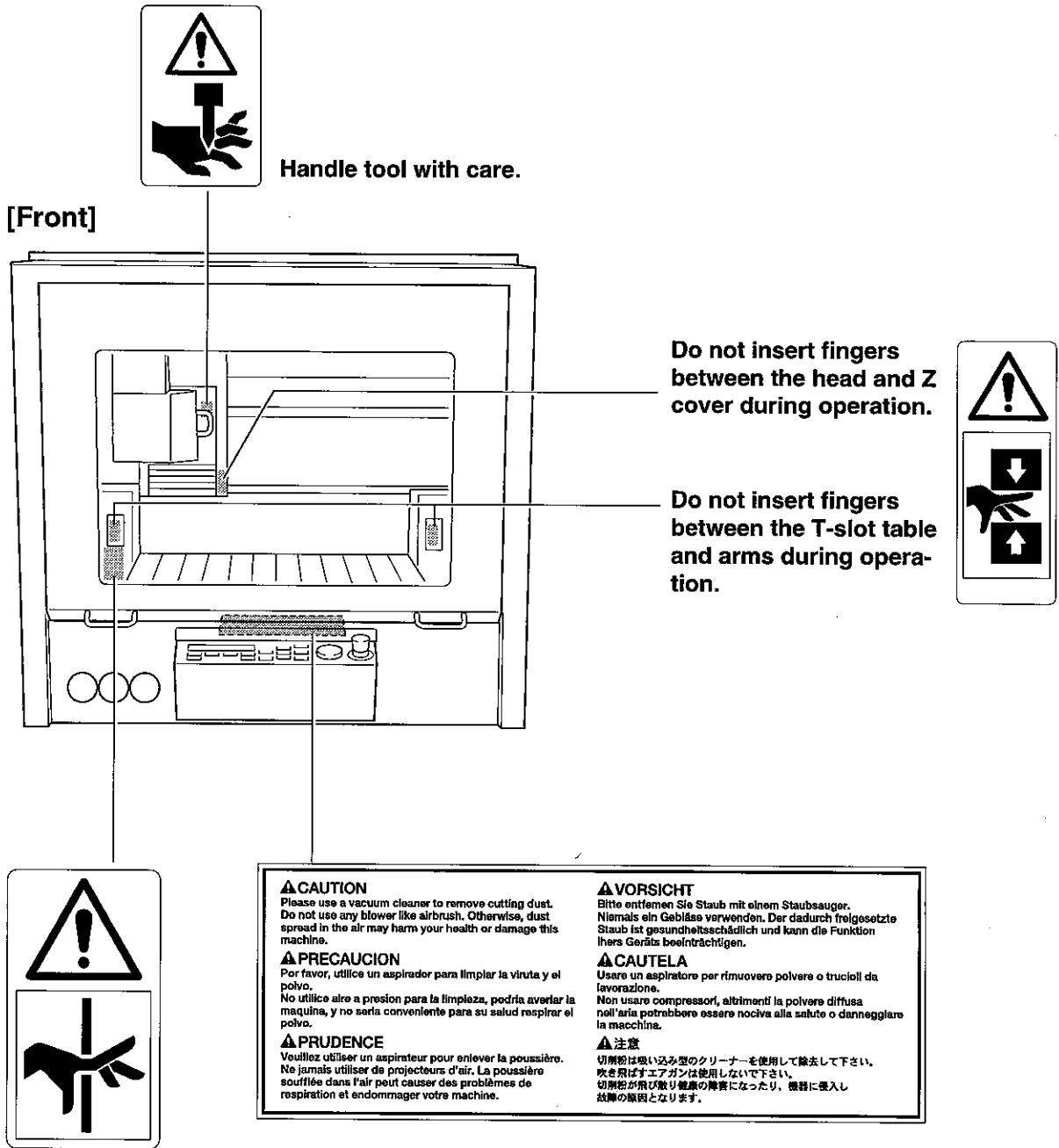

When opening or closing the door, be careful not to pinch your fingers.

[Right side]

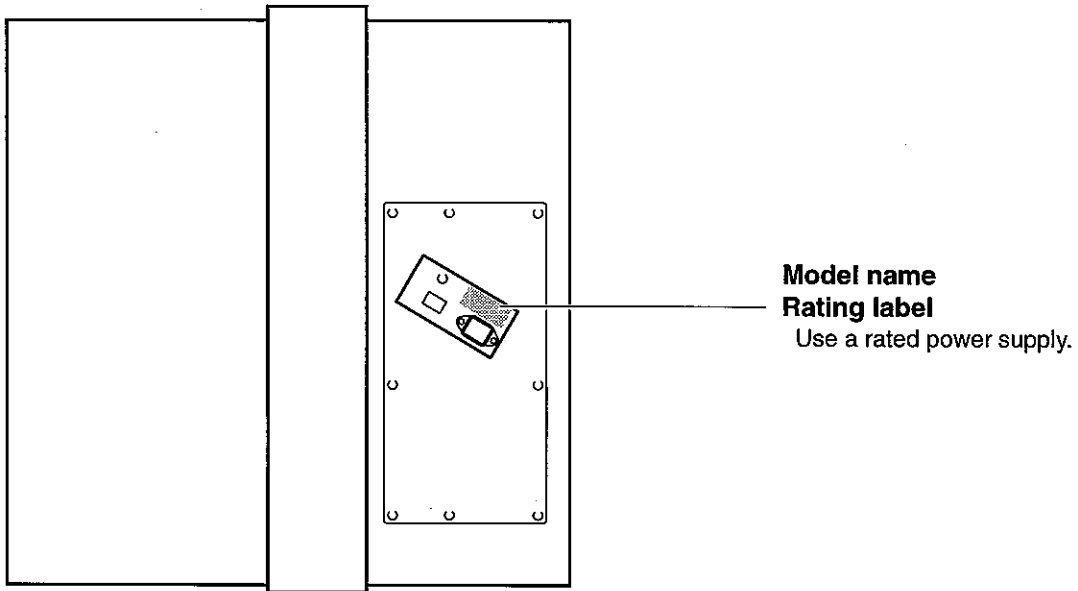

In addition to the **⚠ WARNING** and **⚠ CAUTION** symbols, the symbols shown below are also used.

NOTICE : Indicates information to prevent machine breakdown or malfunction and ensure correct use.



: Indicates a handy tip or advice regarding use.

About This Manual

This document describes the installation, connections, spindle operation, and specifications when the safety cover is installed on the MDX-650/500.

For information about operation of the MDX-650/500, see the respective User's Manual.

NOTICE Fasten the spindle, tool, and material securely in place. Failure to do so may lead to faulty operation or breakdown.

Do not operate beyond capacity or subject the tool to undue force. Doing so may lead to faulty operation or breakdown.

1 Names of Parts

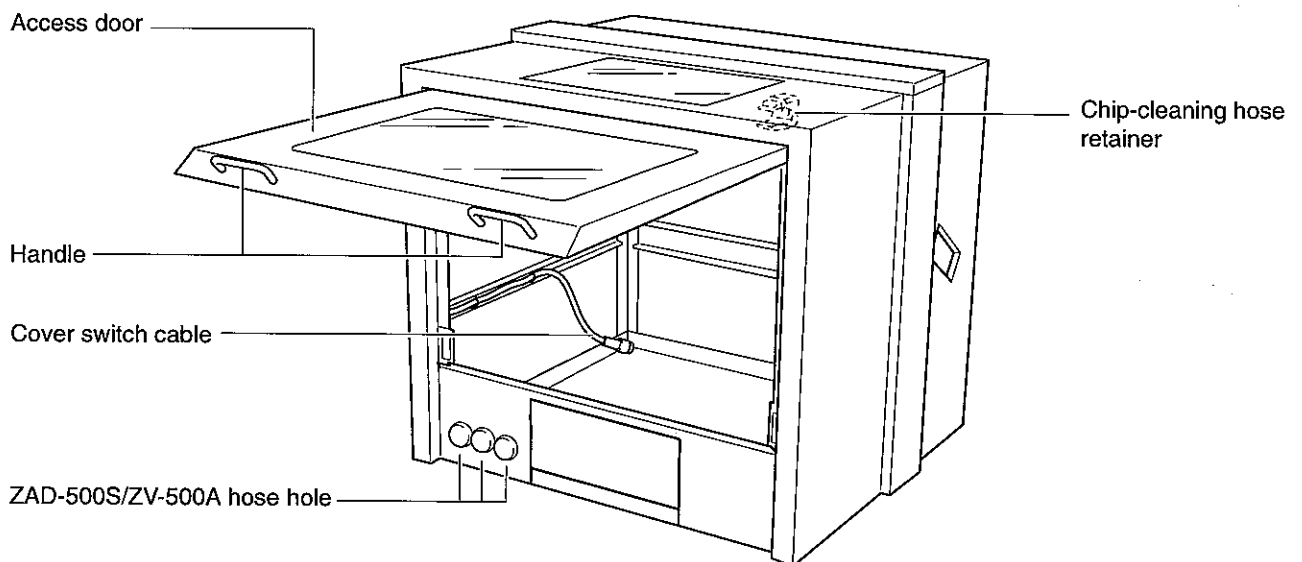

2 Setting Up

⚠ CAUTION



Unpacking, installation, and moving are operations that must be carried out by five or more persons for the MDX-650 and by four or more persons for the MDX-500.

Failure to do so may result in falling of the unit, leading to injury.

(The MDX-650 weighs 120 kg (264.5 lb.), and the MDX-500 weighs 92 kg (202.8 lb.).)

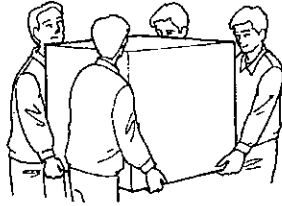

Install on a stable surface.

Failure to do so may result in falling of the unit, leading to injury.

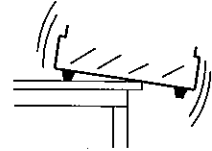

NOTICE

Use within a temperature range of 5 to 40°C (41 to 104°F) and within a humidity range of 35 to 80%.

Do not place any object except tools or workpiece materials inside the safety cover. Doing so may not only obstruct operation, it may result in machine breakdown.

When you are installing the MDX-650/500 and the safety cover on a table with casters, securely engage the caster stoppers.

Do not place objects on the heads of the MDX-650/500 or on the safety cover.

To prevent accidents, do not install in any of the following types of areas.

- Avoid use in areas subject to strong electric noise.
- Avoid use in areas subject to high humidity or dust.
- The MDX-650/500 generates heat when used, and should not be installed in an area with poor heat radiation characteristics.
- Do not install in an area subject to strong vibration.

Installation requires the following access space.

ZBX-650

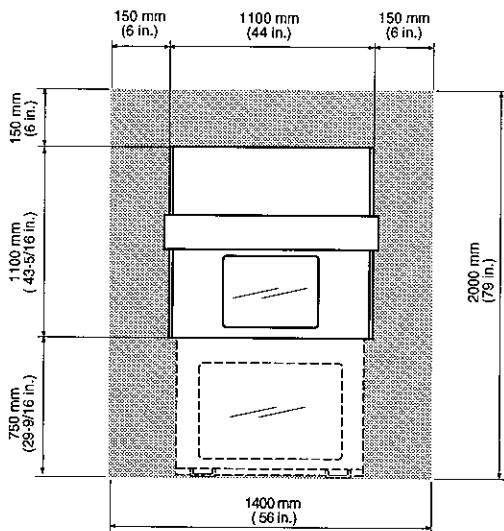

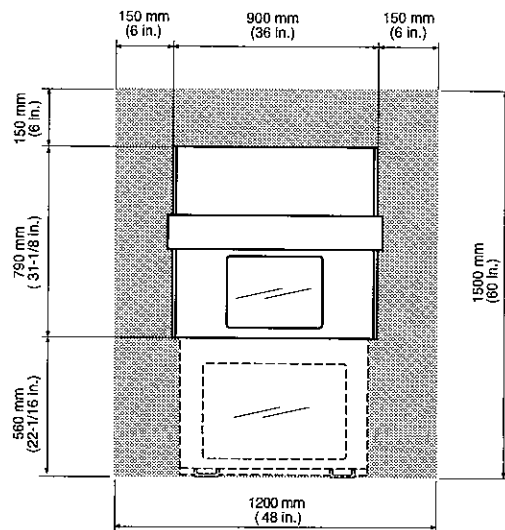

ZBX-500A



3 Connection

⚠ WARNING

 Do not use with any electrical power supply that does not meet the ratings displayed on the unit. Use with any other power supply may lead to fire or electrocution.

 **Ground the unit with the ground wire.**
Failure to do so may result in risk of electrical shock in the even of a mechanical problem

 **Use only with the power cord included with this product.**
Use with other than the included power cord may lead to fire or electrocution.

⚠ CAUTION

 Do not connect the power cord with other electrical loads on a single electrical outlet. Doing so may generate heat and cause fire.

 **If you are using the safety cover, detach the key connector from the MDX-650/500.**
Unintended operation may cause injury.

NOTICE Be sure that the power to both the computer and the main unit is switched off when connecting the cable.

Securely connect the power cord, computer I/O cable and so on so that they will not be unplugged and cause failure during operation. Doing so may lead to faulty operation or breakdown.

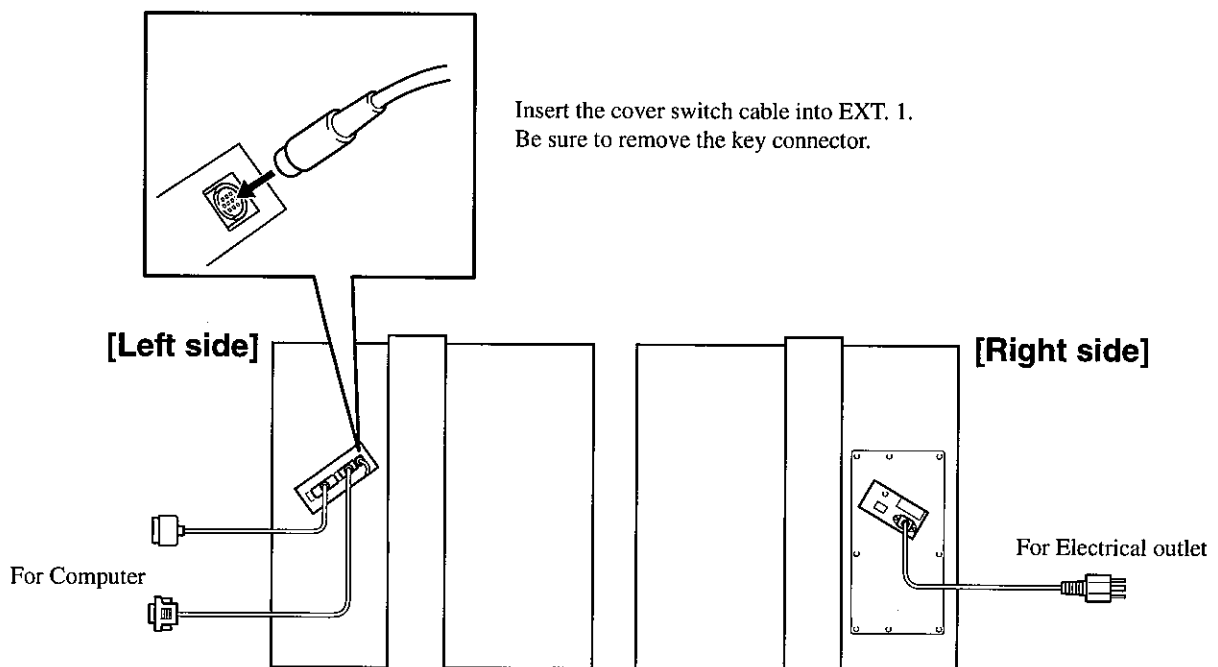

For information about making the connections, see MDX-650/500 User's Manual 1 —“Setup and Maintenance.”

4 Spindle Action

NOTICE Do not open the safety cover, during cutting. Opening the cover during cutting results in an emergency stop. Any cutting data in use becomes invalid, and cutting cannot be continued.

While the safety cover is open, the spindle does not turn. At this time, it is also not possible to make the spindle turn using the control keys.

When sending operating instructions from the host computer or when rotating the spindle with the control keys, close the safety cover.

5 Use and Handling of the Cover

Opening and Closing the ZBX-650 Door

CAUTION



When opening or closing the safety cover, grasp the handle with both hands.

The fingers may be pinched, resulting in injury.

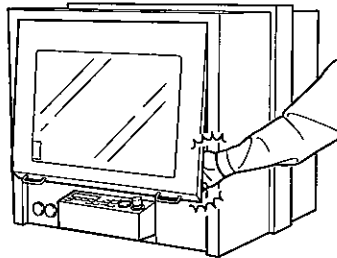

When opening the ZBX-650 door, grasp the handles with both hands lift the door up out of the groove, then pull the door back toward you.

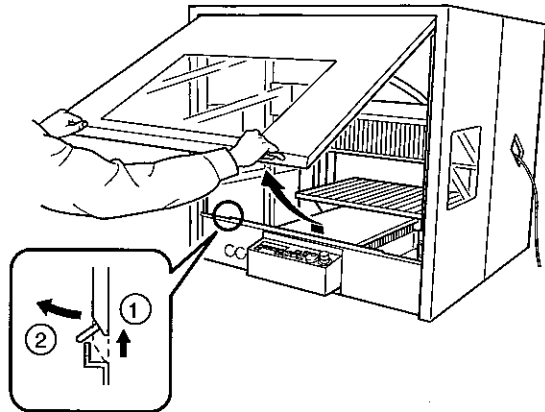

When closing the door, after lowering the door to the closed position, lift it slightly and press inward to fit the edge of the door into the groove.

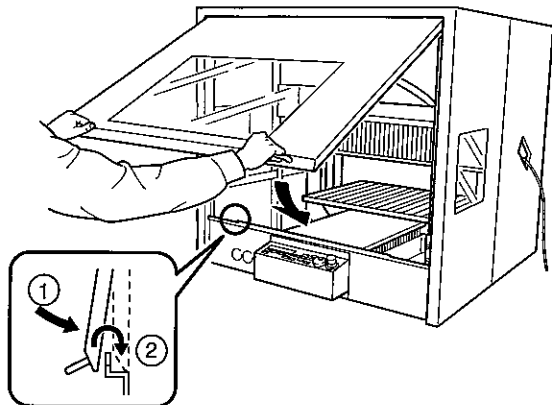

Removing the Cover for Maintenance

CAUTION



Switch off the machine and unplug the power cord from the electrical outlet before performing cleaning or maintenance.

Failure to do so may result in injury or electrical shock.

When opening the base cover of the MDX-650/500 to clean out cutting waste, you must detach the front part of the safety cover in advance. Remove the four screws shown in the figure.

After maintenance has finished, attach the front part of the safety cover at its original position, then tighten the four screws securely.

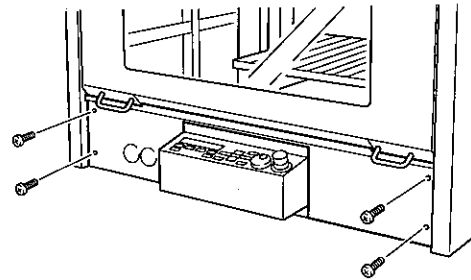

*Do not remove anything other than the four screws shown in the figure.

Specifications

	ZBX-650	ZBX-500A
Dimensions	1042 mm (W) x 1030 mm (D) x 798 mm (H) (41-1/16 (W) x 40-9/16 (D) x 38-9/16 (H) in.)	900 mm (W) x 790 mm (D) x 810 mm (H) (35-7/16 (W) x 31-1/8 (D) x 31-15/16 (H) in.)
Weight (Safety cover alone)	68 kg (149.9 lb.)	53 kg (116.8 lb.)
Acoustic noise level	During no-load operation: 69 dB (A) or less	(According to ISO 7779) —
	Standby mode: 50 dB (A) or less	

 **Roland**