

# PICZA

**3D SCANNER**

# PIX-4

## USER'S MANUAL

Thank you very much for purchasing the PIX-4.

- To ensure correct and safe usage with a full understanding of this product's performance, please be sure to read through this manual completely and store it in a safe location.
- Unauthorized copying or transferral, in whole or in part, of this manual is prohibited.
- The contents of this operation manual and the specifications of this product are subject to change without notice.
- The operation manual and the product have been prepared and tested as much as possible. If you find any misprint or error, please inform us.

**For the USA**

**FEDERAL COMMUNICATIONS COMMISSION  
RADIO FREQUENCY INTERFERENCE  
STATEMENT**

This equipment has been tested and found to comply with the limits for a Class A digital device, pursuant to Part 15 of the FCC Rules.

These limits are designed to provide reasonable protection against harmful interference when the equipment is operated in a commercial environment.

This equipment generates, uses, and can radiate radio frequency energy and, if not installed and used in accordance with the instruction manual, may cause harmful interference to radio communications.

Operation of this equipment in a residential area is likely to cause harmful interference in which case the user will be required to correct the interference at his own expense.

Unauthorized changes or modification to this system can void the users authority to operate this equipment.

The I/O cables between this equipment and the computing device must be shielded.

**For Canada**

**CLASS A NOTICE**

This Class A digital apparatus meets all requirements of the Canadian Interference-Causing Equipment Regulations.

**CLASSE A AVIS**

Cet appareil numérique de la classe A respecte toutes les exigences du Règlement sur le matériel brouilleur du Canada.



**ROLAND DG CORPORATION**

**1-6-4 Shinmiyakoda, Hamamatsu-shi, Shizuoka-ken, JAPAN 431-2103**

**MODEL NAME** : See the MODEL given on the rating plate.

**RELEVANT DIRECTIVE** : **EC MACHINERY DIRECTIVE (98/37/EC)**

**EC LOW VOLTAGE DIRECTIVE (73/23/EEC)**

**EC ELECTROMAGNETIC COMPATIBILITY DIRECTIVE (89/336/EEC)**

# Table of Contents

<b>To Ensure Safe Use</b> .....	2	8 Load the object to be scanned on the PIX-4 .....	19
<b>About the Labels Affixed to the AC Adapter and Unit</b> .....	4	Maximum scanning area of the PIX-4 .....	19
<b>Pour utiliser en toute sécurité</b> .....	5	Load the object to be scanned on the PIX-4 ....	20
<b>À propos des étiquettes collées sur l'adaptateur AC et sur l'appareil</b> .....	7	9 Starting scanning .....	22
Using PICZA (Some Examples of Actual Use) .....	8	About scanning conditions and the scanning area .....	22
Creating elements for 3D computer graphics software .....	8	Setting scanning conditions and starting scanning .....	22
Adding 3D graphics to an internet web page .....	9	Setting the scanning area .....	24
Cutting a three-dimensional object with a modeling machine .....	10	Rescanning a particular portion .....	25
1 Check the included items .....	11	Cancels scanning/Pauses scanning .....	25
2 Part names .....	11	10 Saving scanned data .....	26
3 Setting up and connection .....	12	Edit the scanned data .....	26
4 Installing the Dr.PICZA .....	14	11 Powering OFF .....	26
Symbols used in the section on software .....	14	When not in use .....	26
Overview of Dr. PICZA .....	14	12 Ending Dr. PICZA .....	27
Installing .....	15	13 Items that may not be copied .....	27
5 Starting Dr. PICZA .....	17	14 What to do if... .....	27
About Help .....	17	15 Specifications .....	28
6 Selecting a communication port .....	18		
7 Powering ON .....	19		

Windows® and Windows NT® are registered trademark or trademark of Microsoft® Corporation in the United States and/or other countries.

i486 and Pentium are registered trademarks of Intel Corporation in the United States.



AutoCAD® is registered trademark of Autodesk, Inc.

Mac OS, Macintosh, Power Macintosh, PowerBook, and AppleTalk are registered trademarks or trademarks of Apple Computer, Inc. in the USA and other countries.



PowerPC is trademark of International Business Machines Corporation.

# To Ensure Safe Use

## About ⚠️ WARNING and ⚠️ CAUTION Notices

 <b>WARNING</b>	Used for instructions intended to alert the user to the risk of death or severe injury should the unit be used improperly.
 <b>CAUTION</b>	Used for instructions intended to alert the user to the risk of injury or material damage should the unit be used improperly. * Material damage refers to damage or other adverse effects caused with respect to the home and all its furnishings, as well to domestic animals or pets.

## About the Symbols

	The ⚠️ symbol alerts the user to important instructions or warnings. The specific meaning of the symbol is determined by the design contained within the triangle. The symbol at left means "danger of electrocution."
	The ⚡ symbol alerts the user to items that must never be carried out (are forbidden). The specific thing that must not be done is indicated by the design contained within the circle. The symbol at left means the unit must never be disassembled.
	The ⚡ symbol alerts the user to things that must be carried out. The specific thing that must be done is indicated by the design contained within the circle. The symbol at left means the power-cord plug must be unplugged from the outlet.

## ⚠️ WARNING



**Do not disassemble, repair, or modify.**

Doing so may lead to fire or abnormal operation resulting in injury.



**Do not use with any electrical power supply that does not meet the ratings displayed on the AC adapter.**

Use with any other power supply may lead to fire or electrocution.



**Do not use with any power supply other than the dedicated AC adapter.**

Use with any other power supply may lead to fire or electrocution.



**Do not use while in an abnormal state (i.e., emitting smoke, burning odor, unusual noise, or the like).**

Doing so may result in fire or electrical shock.

Immediately unplug the AC adapter from the electrical outlet, and contact your authorized Roland DG Corp. dealer or service center.

## ⚠️ CAUTION



**Do not use with a damaged AC adapter, power cord, or power-cord plug or with a loose electrical outlet.**

Use with any other power supply may lead to fire or electrocution.

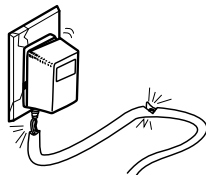

**When not in use for extended periods, unplug the AC adapter from the electrical outlet.**

Failure to do so may result in danger of shock, electrocution, or fire due to deterioration of the electrical insulation.

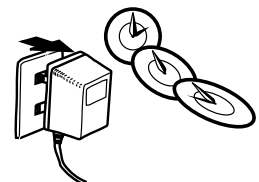

## CAUTION



Do not injure or modify the electrical power cord, nor subject it to excessive bends, twists, pulls, binding, or pinching, nor place any object of weight on it.

Doing so may damage the electrical power cord, leading to electrocution or fire.

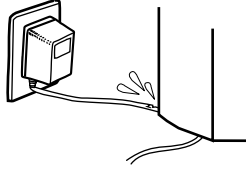

When unplugging the AC adapter from the power outlet, grasp the adapter unit or the plug, not the cord.

Unplugging by pulling the cord may damage it, leading to fire or electrocution.

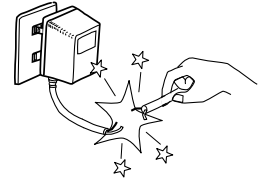

Install on a stable surface.

Failure to do so may result in falling of the unit, leading to injury.

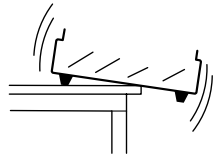

Do not allow liquids, metal objects or flammables inside the machine.

Such materials can cause fire.

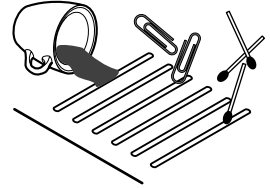

Do not place hands near the main unit while in operation.

Doing so may result in injury.

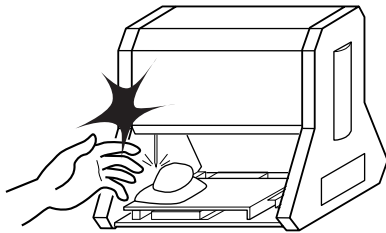

Do not allow children to operate without adult supervision or operate within reach of young children.

Doing so may result in injury.

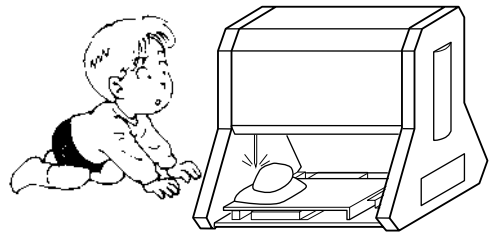

Store clay out of the reach of children.

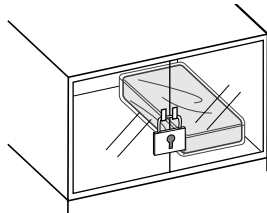

Do not attempt to unplug the AC adapter with wet hands.

Doing so may result in electrical shock.

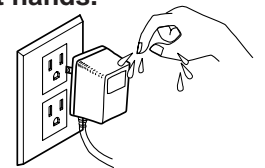

# About the Labels Affixed to the AC Adapter and Unit

These labels are affixed to the body of this product and the AC adapter. The following figure describes the location. The configuration of the AC adapter varies according to regional differences in voltage. Please note that the descriptions in this manual are for the 117 V adapter.

**Front**

**Rear**

**Model label**

**Rating label**

Do not use with any electrical power supply that does not meet the ratings displayed on the AC adapter.

**CAUTION**  
INDOOR USE ONLY  
**PRECAUTION**  
DOMESTIQUE  
USAGE SEULEMENT

<p>▲ CAUTION DISCONNECT MAIN PLUG FROM SUPPLY SOCKET WHEN NOT IN USE MAIN LEADS COLOR CODE: BROWN: LIVE, BLUE: NEUTRAL</p> <p>▲ ATTENTION Quand la machine n'est pas utilisée déconnecter le câble de la prise de courant Code des couleurs Marron: Phase, Bleu: Neutre</p>	<p>▲ ACHTUNG Lösen Sie den Netzanschluß, wenn das Gerät nicht verwendet wird. Die Farbkodierung des Netzkabels lautet folgendermaßen: Braun: Spannung, Blau: Masse</p> <p>▲ 注意 長時間使用しない場合は、ACアダプタをコンセントから抜いて下さい。</p>
---	--

**Do not place hands near the main unit while in operation.**

**When not in use for prolonged periods, unplug the AC adapter from the electrical outlet.**

In addition to the and **CAUTION** symbols, the symbols shown below are also used.



**NOTICE** : Indicates information to prevent machine breakdown or malfunction and ensure correct use.









: Indicates a handy tip or advice regarding use.

# Pour utiliser en toute sécurité

## Avis sur les avertissements

 <b>ATTENTION</b>	Utilisé pour avertir l'utilisateur d'un risque de décès ou de blessure grave en cas de mauvaise utilisation de l'appareil.
 <b>PRUDENCE</b>	Utilisé pour avertir l'utilisateur d'un risque de blessure ou de dommage matériel en cas de mauvaise utilisation de l'appareil. * Par dommage matériel, il est entendu dommage ou tout autre effet indésirable sur la maison, tous les meubles et même les animaux domestiques.

## À propos des symboles

	Le symbole  attire l'attention de l'utilisateur sur les instructions importantes ou les avertissements. Le sens précis du symbole est déterminé par le dessin à l'intérieur du triangle. Le symbole à gauche signifie "danger d'électrocution".
	Le symbole  avertit l'utilisateur de ce qu'il ne doit pas faire, ce qui est interdit. La chose spécifique à ne pas faire est indiquée par le dessin à l'intérieur du cercle. Le symbole à gauche signifie que l'appareil ne doit jamais être démonté.
	Le symbole  prévient l'utilisateur sur ce qu'il doit faire. La chose spécifique à faire est indiquée par le dessin à l'intérieur du cercle. Le symbole à gauche signifie que le fil électrique doit être débranché de la prise.

## **ATTENTION**



### **Ne pas démonter, réparer ou modifier.**

Le non-respect de cette consigne pourrait causer un incendie ou provoquer des opérations anormales entraînant des blessures.



### **Ne pas utiliser avec une alimentation électrique ne respectant pas les caractéristiques indiquées sur l'adaptateur AC.**

Une utilisation avec toute autre alimentation électrique pourrait provoquer un incendie ou une électrocution.



### **Ne pas utiliser avec une alimentation électrique autre que l'adaptateur AC conçu à cet effet.**

Une utilisation avec toute autre alimentation électrique pourrait provoquer un incendie ou une électrocution.



### **Ne pas utiliser si l'appareil est dans un état anormal (c'est-à-dire s'il y a émission de fumée, odeur de brûlé, bruit inhabituel etc.).**

Le non-respect de cette consigne pourrait provoquer un incendie ou des décharges électriques.  
Débrancher immédiatement l'adaptateur AC et contacter votre agent agréé de la compagnie Roland DG ou votre centre de service.

## PRUDENCE



**Ne pas utiliser avec un adaptateur AC ou un fil électrique endommagé ou avec une prise électrique qui a du jeu.**

Une utilisation avec toute autre alimentation électrique pourrait provoquer un incendie ou une électrocution.

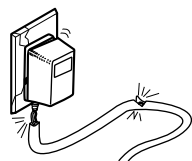

**Quand l'appareil reste inutilisé pendant plusieurs heures, débrancher l'adaptateur AC.**

Le non respect de cette consigne pourrait causer des risques de décharges électriques, d'électrocution, ou d'incendie dus à la détérioration de l'isolation électrique.

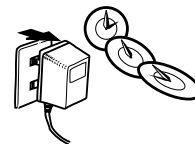

**Ne pas endommager ou modifier le fil électrique. Ne pas le plier, le tordre, l'étirer, l'attacher ou le serrer de façon excessive. Ne pas mettre d'objet ou de poids dessus.**

Une négligence à ce niveau pourrait endommager le fil électrique ce qui risquerait de provoquer une électrocution ou un incendie.

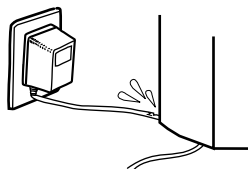

**Lorsque vous débranchez l'adaptateur AC, saisir et tirer le bloc adaptateur et non le fil électrique.**

Débrancher en tirant sur le fil pourrait l'endommager et risquer de provoquer un incendie ou une électrocution.

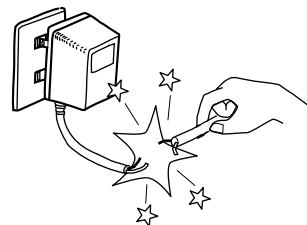

**Installer l'appareil sur une surface stable.**

Une négligence à ce niveau pourrait provoquer la chute de l'appareil et entraîner des blessures.

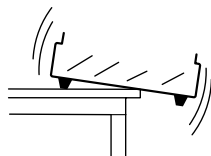

**Ne pas introduire de liquide, d'objet métallique ou inflammable dans l'appareil.**

Ce genre de matériel peut provoquer un incendie.

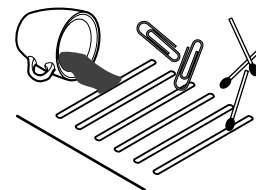

**Ne pas placer vos mains près de l'unité principale pendant son fonctionnement.**

Le non respect de cette consigne pourrait causer des blessures.

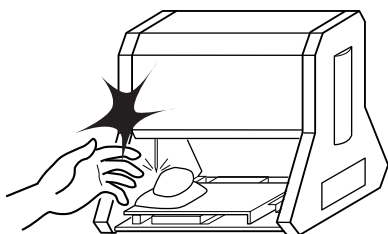

**Ne pas laisser des enfants faire fonctionner l'appareil sans la surveillance d'un adulte ni laisser l'appareil en fonctionnement à la portée d'enfants en bas âge.**

Une négligence à ce niveau pourrait provoquer des blessures.

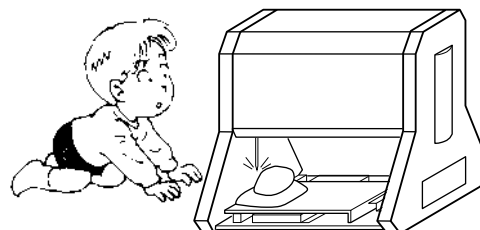

**Ranger la pâte hors de la portée des enfants.**

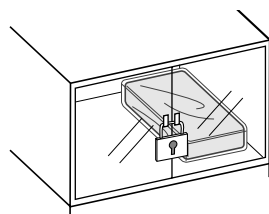

**Ne pas débrancher l'adaptateur AC avec des mains mouillées.**

Une négligence à ce niveau pourrait provoquer des décharges électriques.

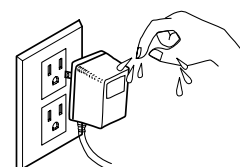



# À propos des étiquettes collées sur l'adaptateur AC et sur l'appareil

Ces étiquettes sont collées sur le corps de l'appareil et sur l'adaptateur AC. Le dessin suivant indique leur emplacement. La configuration de l'adaptateur AC varie selon les différences de voltage régionales. Veuillez noter que les descriptions dans ce manuel correspondent à un adaptateur de 117 volts.



Avant



Ne pas placer vos mains près de l'unité principale pendant son fonctionnement.

Nom du modèle

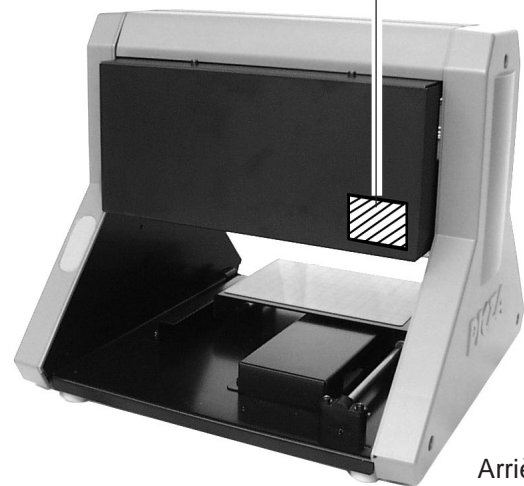

Arrière

## Étiquette des caractéristiques électriques

Ne pas utiliser avec une alimentation électrique ne respectant pas les caractéristiques indiquées sur l'adaptateur.

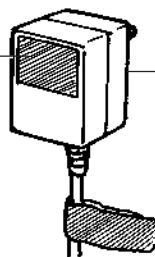

**CAUTION**  
INDOOR USE ONLY  
**PRECAUTION**  
DOMESTIQUE  
USAGE SEULEMENT

**▲ CAUTION**  
DISCONNECT MAIN PLUG FROM SUPPLY SOCKET WHEN NOT IN USE  
MAIN LEADS COLOR CODE:  
BROWN: LIVE, BLUE: NEUTRAL  
**▲ ATTENTION**  
Quand la machine n'est pas utilisée déconnecter le câble de la prise de courant  
Code des couleurs  
Marron: Phase, Bleu: Neutre

**▲ ACHTUNG**  
Lösen Sie den Netzanschluß, wenn das Gerät nicht verwendet wird.  
Die Farbkodierung des Netzkabels lautet folgendermaßen:  
Braun: Spannung, Blau: Masse  
**▲ 注意**  
長時間使用しない場合は、ACアダプタをコンセントから抜いて下さい。

Quand l'appareil reste inutilisé pendant une longue période, débrancher l'adaptateur AC.

# Using PICZA (Some Examples of Actual Use)

This section presents some actual examples of how PICZA can be put to use.

## Creating elements for 3D computer graphics software

Dr. PICZA offers a function for exporting files in three-dimensional DXF format (AutoCAD® Release 12 format). This section explains how to use a commercially available 3D computer-graphics software application that can import DXF-format files to create your own original illustrations. (This product does not include 3D computer-graphics software, which must be obtained from another source.)

**1** Visualize in detail the design illustration you wish to create. In this example, we'll make the illustration shown below.

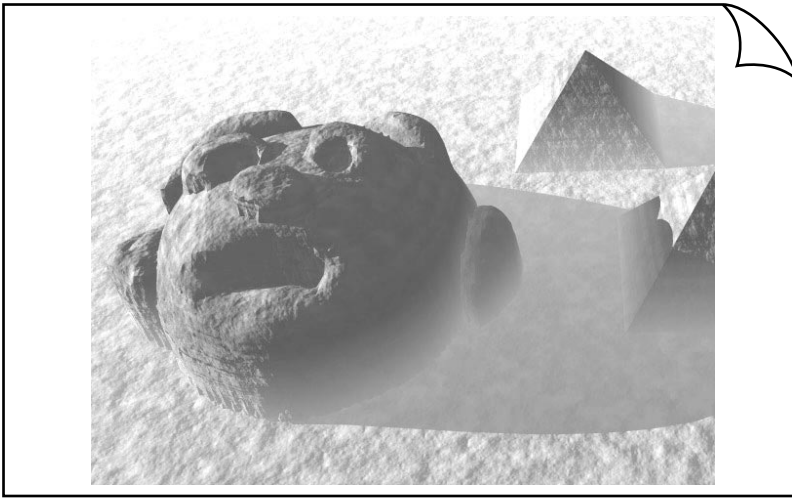

**2** Create the elements that make up the illustration. In this example, we'll use the clay included with the product to make the face, and the graphics software to make the other element (the pyramid).



**3** Scan the clay face and export the data in DXF format.

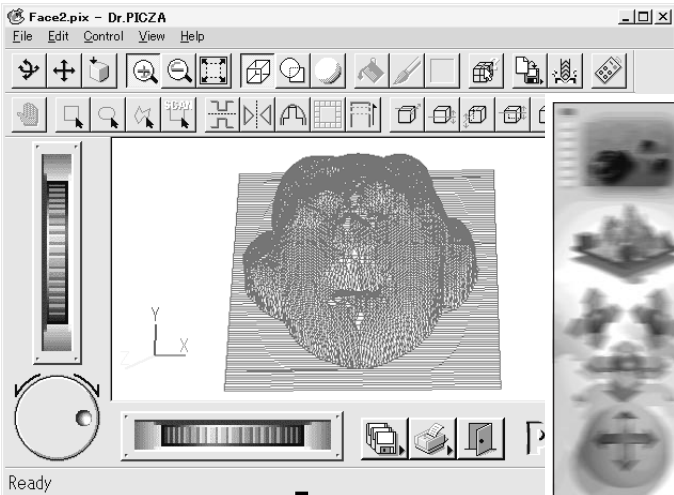

**4** Launch the 3D graphics application and import the DXF file. Make the pyramid and arrange the face and the pyramid using the layout shown below.

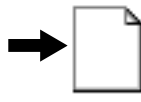
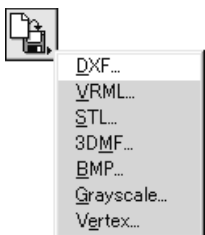
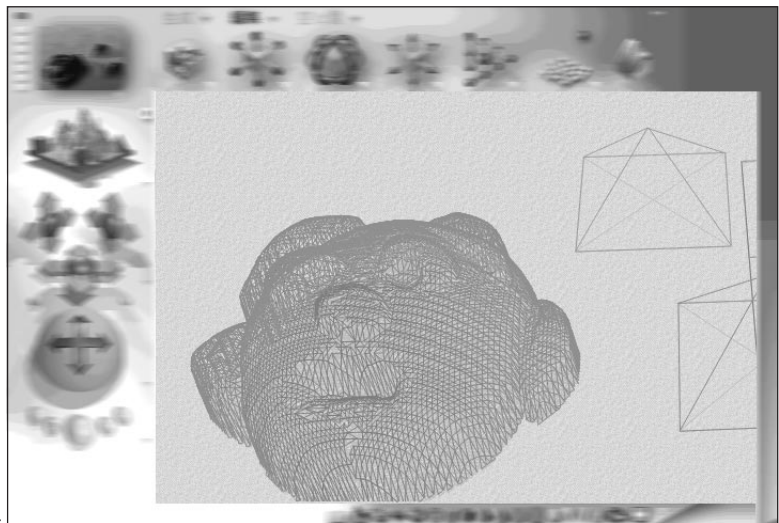

DXF-format file

**5** Use the 3D graphics software to color the illustration, then print it out.

# Adding 3D graphics to an internet web page

Dr. PICZA comes with a function for exporting files in VRML format (Ver.1.0). VRML (Virtual Reality Modeling Language) is a language used to display 3D graphics on the World Wide Web, where they can be viewed using a web browser capable of displaying VRML files. Color data from Dr. PICZA is also preserved in these VRML files. In this example, we'll add the image of a original fishing lure scanned with the PIX-4 to a web page. (This product does not include a web browser or web-page authoring software, which must be obtained from another source.)

- 1 Set the lure in place on the workpiece table and scan it with the PIX-4. In this example, we'll scan only one side of the lure, and use Dr. PICZA's [Add Backside Faces] function to make a complete three-dimensional representation.

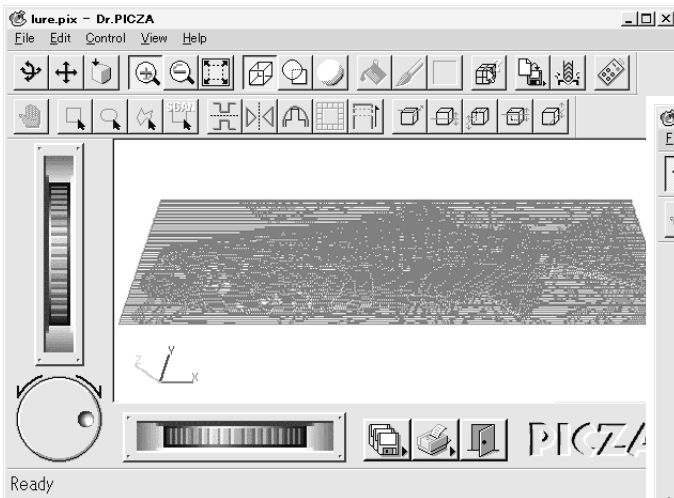

- 2 Use Dr. PICZA to color the scanned data. (For details on adding color, please refer to the help screens for Dr. PICZA.)

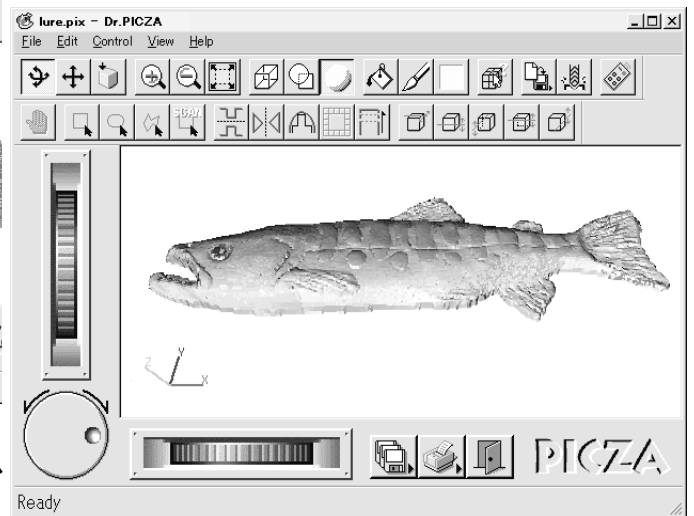

- 3 Under [File] - [Preferences...], click [Add Backside Faces] to turn it on, then export the data in VRML format.

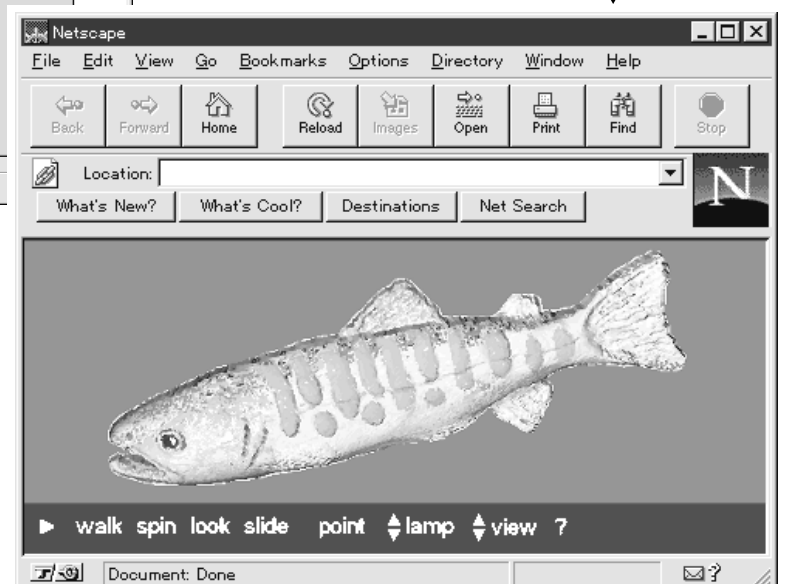
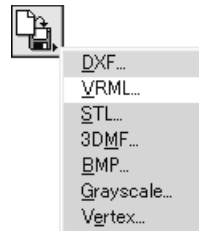
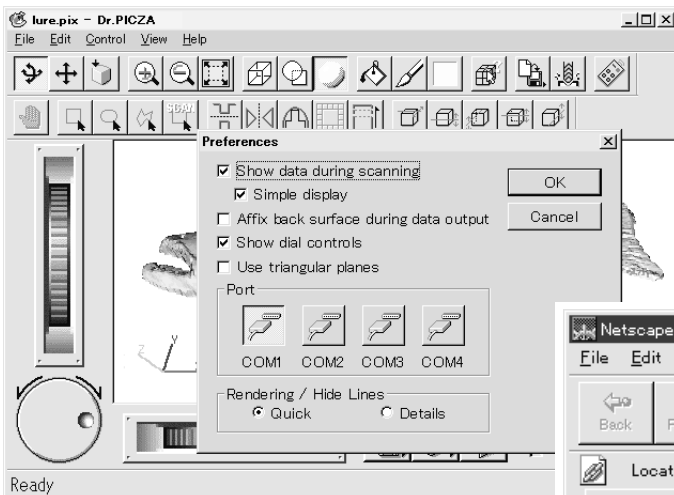

- 4 VRML files can be opened and viewed with a web browser that supports the VRML format. By adding a link to a VRML file from a web page, you can also display the VRML file on the World Wide Web. (For details on how to do this, please refer to the documentation for your web-page authoring software or a third-party guide to HTML.)

# Cutting a three-dimensional object with a modeling machine

Dr. PICZA has a function for exporting data to MODELA PLAYER. MODELA PLAYER is software for cutting three-dimensional objects on the MODELA, CAMM-3, or CAMM-2, three-dimensional modeling machines made by Roland DG Corp. Dr. PICZA can output 3D data directly to MODELA PLAYER. In this example, we'll use the MODELA in combination with Dr. PICZA to make a paperweight in the shape of a leaf. The explanation assumes that you already have the MODELA installed and set up.

- 1** Get a suitable leaf from a tree, and press it into a piece of clay to transfer the image of the leaf to the clay.

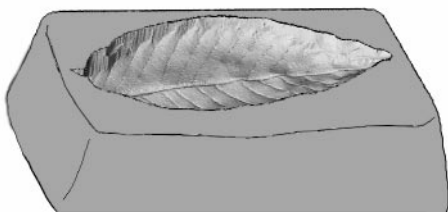

- 2** Set the piece of clay on the workpiece table and scan it with the PIX-4.

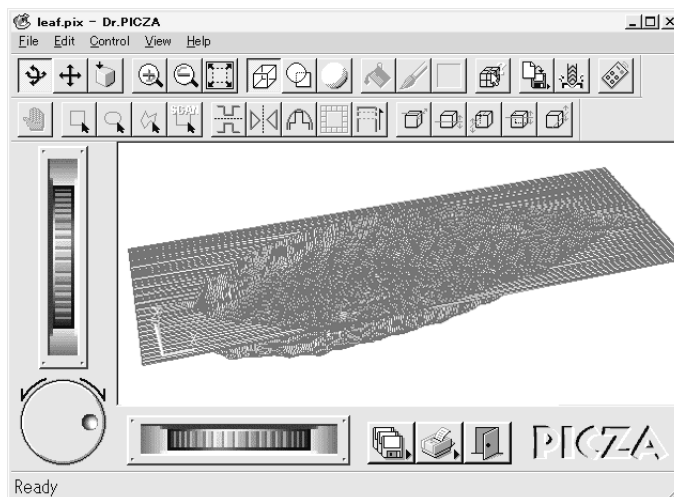

- 3** Use [Edit] - [Invert] to invert the scanned shape, then export the data to MODELA PLAYER.

Before inversion

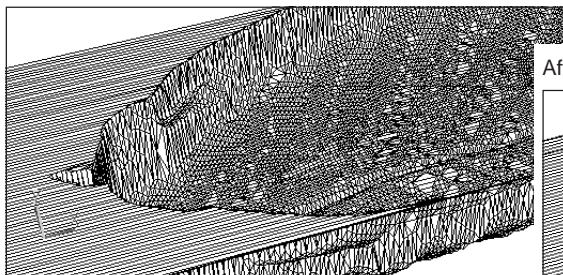

After inversion

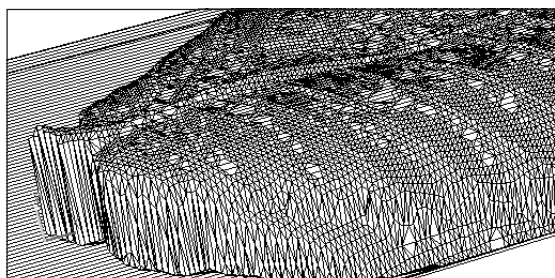

Export to  
MODELA  
PLAYER

- 4** Use MODELA PLAYER to cut the shape on the MODELA.

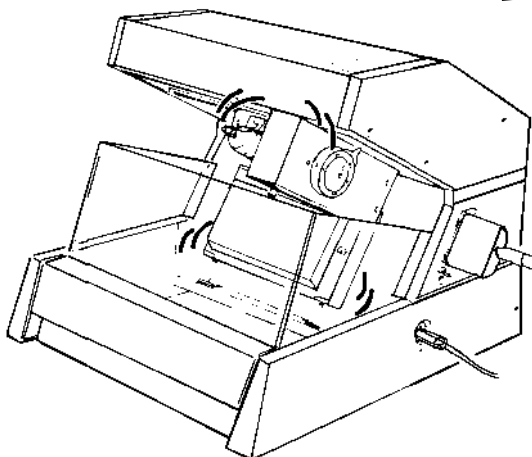

- 5** Color the cut object.

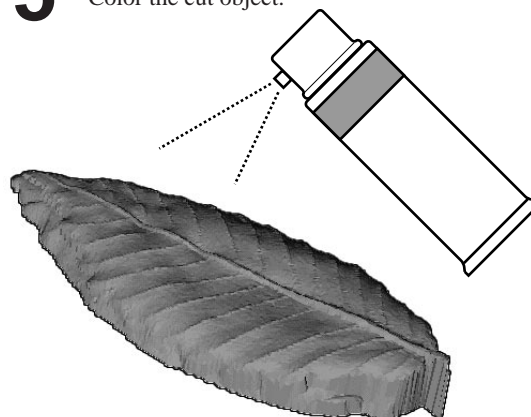



# 1 Check the included items

Dr.PICZA for Windows  
disks: 2

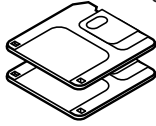

Dr.PICZA for Mac OS  
disk: 1



AC adapter: 1

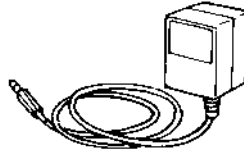

The configuration of the AC adapter varies according to regional differences in voltage. Please note that the descriptions in this manual are for the 117 V adapter.

Clay: 1

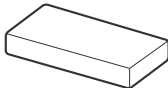

PIX-4 User's manual: 1

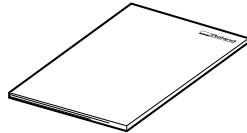

# 2 Part names

**NOTICE** Do not attempt to move the table by hand.

Do not put the hands inside the unit.  
Doing so may result in breakdown  
of the unit.



Do not put  
hands inside.

**Sensor**  
This remains inside the cover  
except during scanning.

STANDBY  
LED

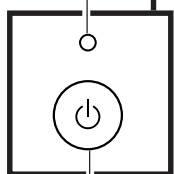

STANDBY key

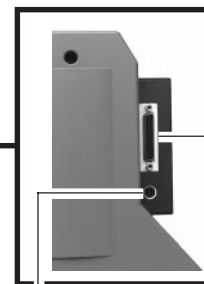
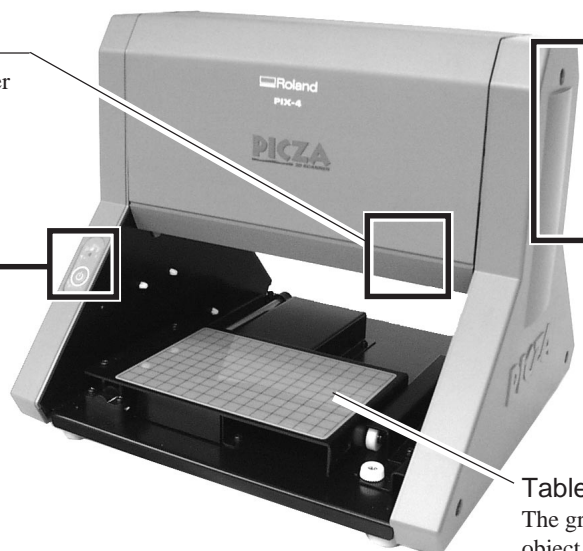

Serial connector

AC adapter jack

**Table**

The grid on the table serves as a guide for mounting the object to scan.  
It does not indicate the scanning area for Dr. PICZA.  
The scale is in 10-mm (about 3/8 in.) units.

---

## 3 Setting up and connection

### WARNING



**Do not use with any electrical power supply that does not meet the ratings displayed on the AC adapter.**  
Use with any other power supply may lead to fire or electrocution.



**Do not use with any power supply other than the dedicated AC adapter.**  
Use with any other power supply may lead to fire or electrocution.

### CAUTION



**Install on a stable surface.**  
Failure to do so may result in falling of the unit, leading to injury.

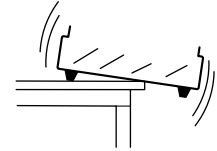

---

### NOTICE

Never install this unit in any of the following situations, as it could result in damage:

- Places where the installation surface is unstable or not level.
- Places with excessive electrical noise.
- Places with excessive humidity or dust.
- Places with poor ventilation, because the PIX-4 generates considerable heat during operation.
- Places with excessive vibration.

---

Use within a temperature range of 5 to 40°C (41 to 104°F) and within a humidity range of 35 to 80%.

---

Securely connect the power cord, computer I/O cable and so on so that they will not be unplugged and cause failure during operation. Doing so may lead to faulty operation or breakdown.

---

When you carry the PIX-4, use two hands to securely grip this area on the left and right sides.

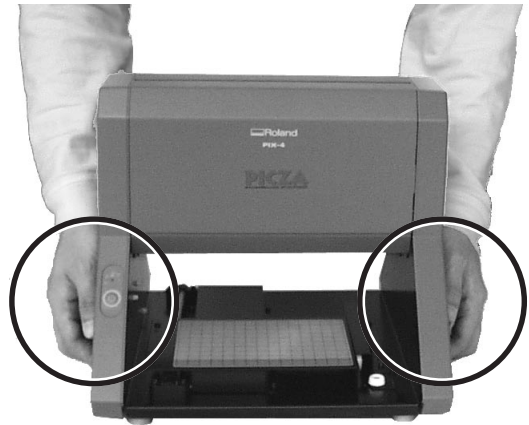

## For IBM PC or PC compatible

### Serial connector

Use a commercially available Phillips screwdriver to tighten the screws at either end of the serial cable.

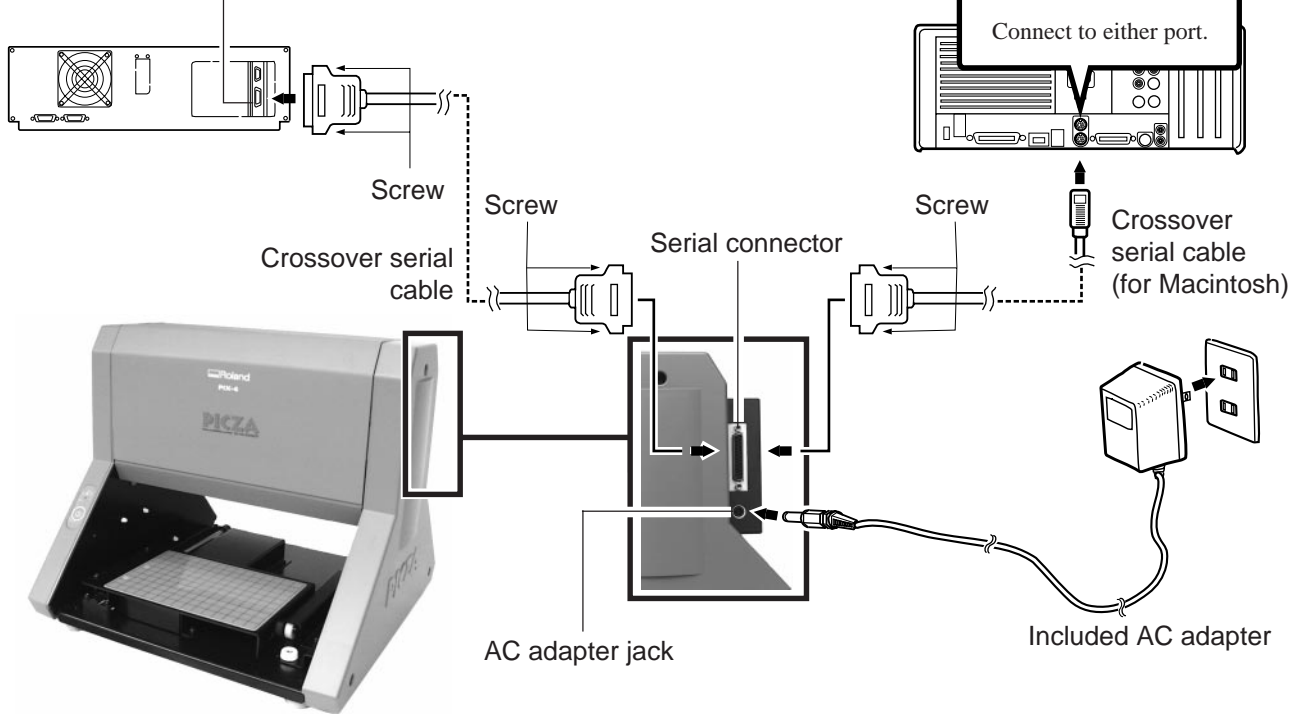

## For Macintosh

Printer port

Modem port

Connect to either port.

Crossover serial cable (for Macintosh)

AC adapter jack

Included AC adapter

- During scanning, the table moves forward and backward. If the mounted scan object (the three-dimensional object to be scanned) is larger than the table size, it may extend beyond the front and rear of the unit. Do not place any objects in the area.
- For the cable, use a commercially available crossover serial cable (RS-232C rating). A straight serial cable such as is commonly used to connect a modem cannot be used. For more on how to connect a serial cable for Macintosh, see "15 Specifications -- Serial Cable for Macintosh."
- Make sure the power to the computer and the PIX-4 is switched off before attempting to connect the cables.

## Freeing the table

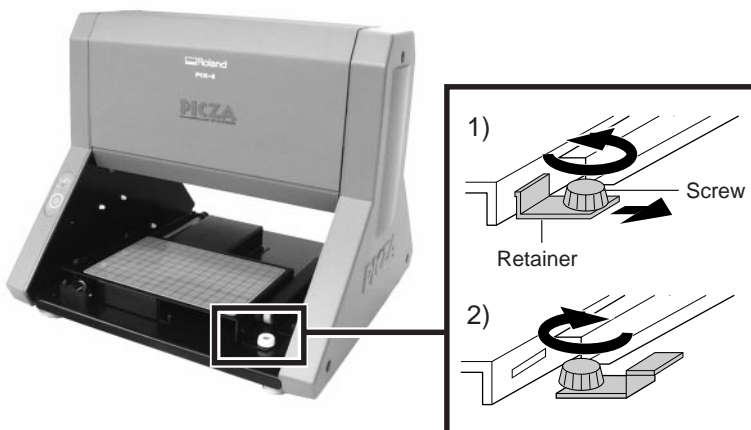

- 1) Before using the unit, remove the screw and the retainer shown in the figure. The table does not move if it remains secured in place by the retainer.
- 2) Attach the retainer in the orientation shown in the figure, and tighten the screws.

\* The screws and retainer are necessary when repacking the unit. Do not discard them.

# 4 Installing the Dr.PICZA

## Symbols used in the section on software

When the procedures for Windows and for the Mac OS are different, both are described. When the procedures are similar, the explanations use the screens for the Windows version. In such cases, the screen images may differ from those for the Mac OS version, but the procedures do not change.

### Overview of Dr. PICZA

\* For details, please refer to the help screens for Dr. PICZA.

A Quick Overview of Available Functions	Toolbar button				
Set scanning conditions and perform scanning					
View scanned 3D data from various angles					
Zoom in or out on the on-screen view of scanned data					
Make settings for how scanned 3D data is displayed					
Displays the coordinates of the scanned object					
Color the faces of scanned 3D data					
Edit scanned 3D data					
Adjust the slant of scanned 3D data					
Specify the data format and save the scanned 3D data					
Launch the MODELA PLAYER					



---

# Installing

## Setting Up the Windows Version of the Program

### Operating environment

	Dr.PICZA for Windows
Computer	Personal computer running Windows 95, Windows 98, or Windows NT 4.0
CPU	If you're using Windows 95: i486SX or better (Pentium 100 MHz recommended) If you're using Windows 98 or Windows NT 4.0: i486DX or better (Pentium 100 MHz recommended)
System Memory	If you're using Windows 95: 8 MB or more (10 MB or more recommended) If you're using Windows 98 or Windows NT 4.0: 16 MB or more (32 MB or more recommended)
Hard Disk	3 MB or more of free space

### Setup

\* When setting up the software under Windows NT 4.0, log on as the member of a group other than [Guest].

Hard disk : C  
Floppy-disk drive : A \* If your drive-name assignments differ from the ones shown at left, make the appropriate changes.

- 1 Switch on the computer and start Windows.
- 2 Insert the Dr. PICZA for Windows disk 1/2 included with the unit.
- 3 Double-click on the [My Computer] icon on screen.
- 4 Double-click on the [3-1/2 Floppy] icon.

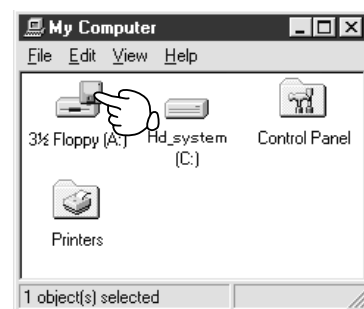

- 5 Double-click on the [setup.exe] icon.

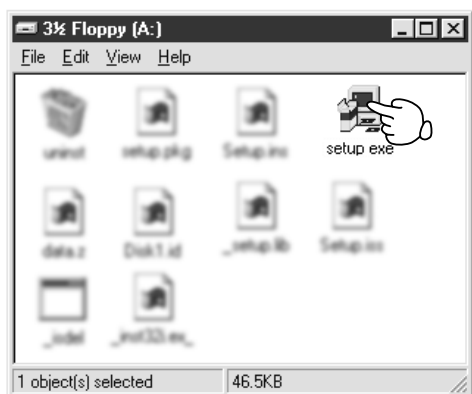

This starts the setup program. Follow the messages to carry out setup. For MODELA PLAYER, at the screen for selecting the machine, make the setting for the Roland DG Corp.'s modeling machine you're using.

## Setting Up the Mac OS Version of the Program

### Operating environment

	Dr.PICZA for Mac OS
Computer	A Power Macintosh, or PowerBook with a PowerPC processor.
System	Mac OS 7.5 or higher
System Memory	20 MB or more (40 MB or more recommended)
Hard Disk	3 MB or more of free space

### Setup

- 1 Turn off any virus-detection software.
- 2 Insert the Dr. PICZA for Mac OS disk in the disk drive.

- 3 Double-click the disk icon.



- 5 Double-click the Installer icon.

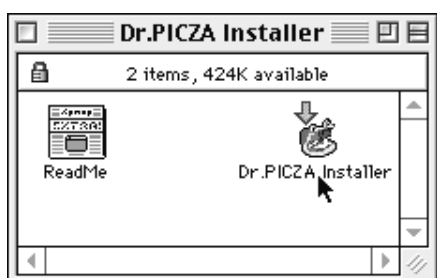

- 4 Double-click the [Read Me] icon and read the file. When you're finished reading, open the [File] menu and choose [Quit].

- 6 When the Installer's start screen appears, click [Continue...].

- 7 Choose where to install the program and click [Install]. Installation starts.

- 8 When installation finishes, click [Quit].

# 5 Starting Dr. PICZA

## For Dr. PICZA for Windows OS

Press the Start button and select [Dr. PICZA].

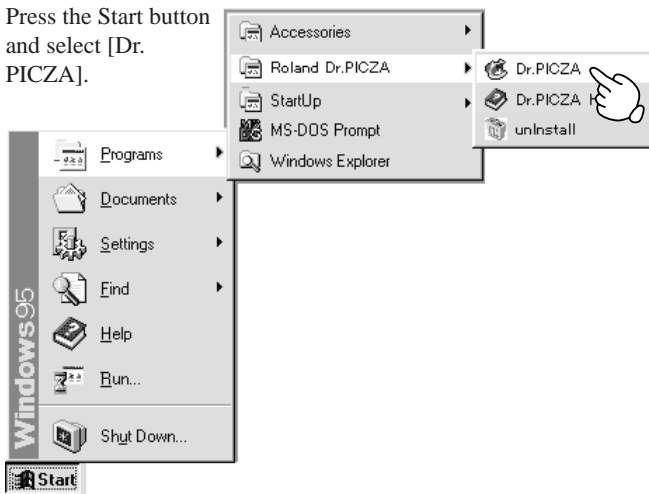

## For Dr. PICZA for Mac OS

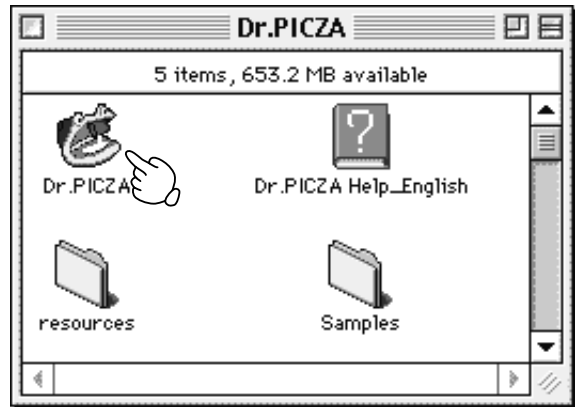

## About Help

If you're unsure how perform an operation while you're working, taking a look at Help can find the answer. If you're using Dr. PICZA for the first time, please be sure to read the Help screens. You can call up Help from the software menus.

## For Dr. PICZA for Windows OS



## For Dr. PICZA for Mac OS

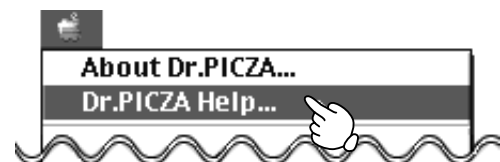

# 6 Selecting a communication port

## For Dr. PICZA for Windows OS

1 From the [File] menu, click [Settings].

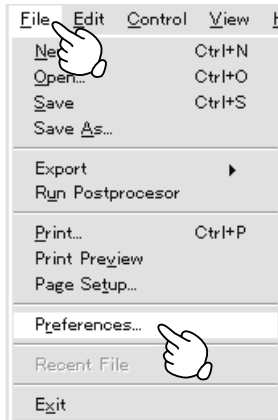

2 Select the port where the cable is connected, then click [OK].

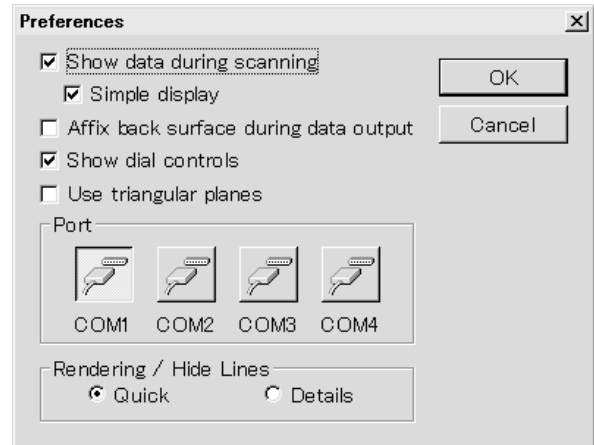

### If You're Using Windows NT 4.0

If the printer port for Windows driver and the communication port for Dr. PICZA are set to the same port, you cannot use Dr. PICZA.

To perform scanning, specify an unused port for the Dr. PICZA communication port.

## For Dr. PICZA for Mac OS

1 Press the File button and select [Preferences...].



2 Select the port where the cable is connected, then click [OK].

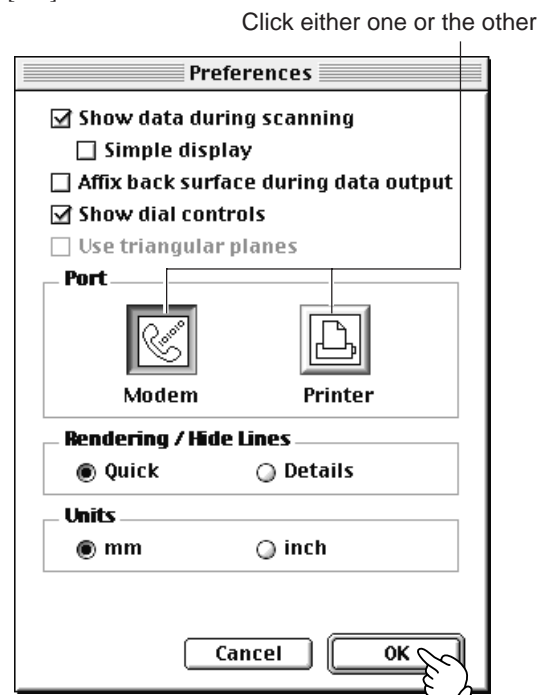

If Dr. PICZA selects the same communication port as AppleTalk, the scanning cannot be processed. In this case, please change the setting of Dr. PICZA so as to use another port. Or, disable the AppleTalk.

# 7 Powering ON

**NOTICE** Before switching on the power to the PIX-4, turn on the computer.

- 1 Press the STANDBY key.  
The STANDBY LED lights up.

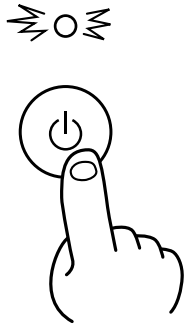

- 2 The unit performs its initialization routine, then stops.  
The sound that occurs during initial operation is not abnormal.

\* When the unit is in its initialized state immediately switching on the power, an error may be displayed if some object touches the sensor. (When an error has occurred, the STANDBY LED intermittently flashes twice.)  
If this happens, switch off the power, remove the object touching the sensor, then switch the power back on.

# 8 Load the object to be scanned on the PIX-4

The sensors for the PIX-4 are highly sensitive, and can even scan three-dimensional objects made out of clay. You can usually perform scanning if the three-dimensional object is of a composition and configuration that can retain its shape. However, the pressures that the sensors detect are from several grams to several tens of grams, so you cannot scan objects whose shape changes when touched by the sensors. (Pressure may fluctuate, depending on the composition of the object being scanned.) For instance, it may not be possible to scan something like a fuzzy stuffed animal.

## Maximum scanning area of the PIX-4

The maximum scanning area is shown in the figure.

The grid on the table serves as a guide for mounting the object to scan. It does not indicate the scanning area for Dr. PICZA. The scale is in 10-mm (3/8 in.) units.

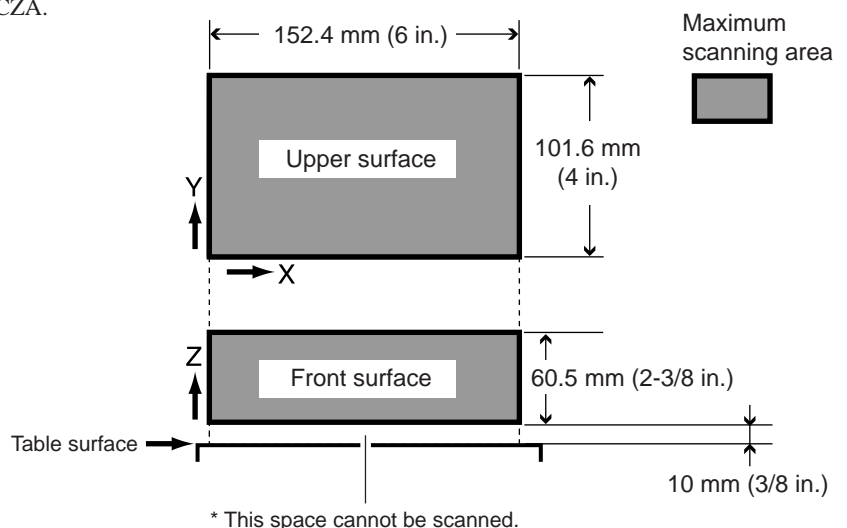

# Load the object to be scanned on the PIX-4

## NOTICE

When securing the scan object in place, be sure to use the included clay or adhesive sheet. Do not use double-sided tape or other strongly adhesive materials. Such materials may cause the table surface to peel.

During scanning, the table moves forward and backward. Mount the object to be scanned so that it does not touch the inner wall of the PIX-4.

## 1) Decide on which surface of the scan object to scan.

When mounting the object, secure it in place with the surface to scan facing up.

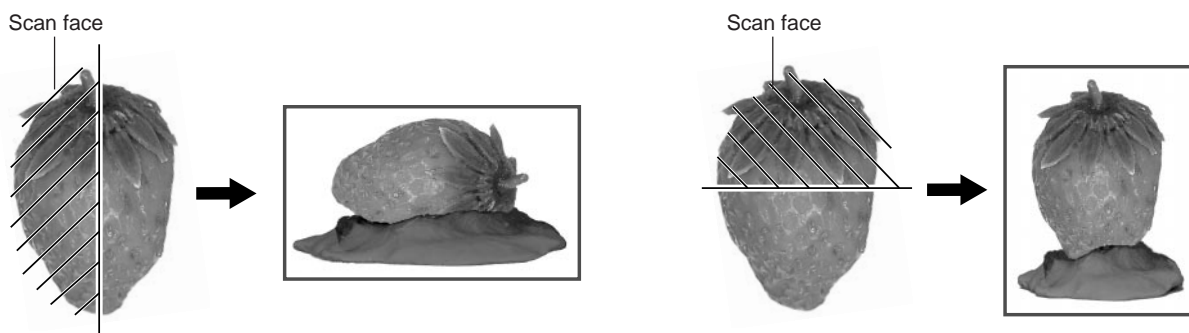

## 2) Use the spacers to adjust the height so that the portion you want to scan lies within the scanning area.

Scanning cannot be performed in the area up to 10 mm (3/8 in.) above the table surface.

Mount so that the portion you want to scan is at a height of 10 mm (3/8 in.) or more above the table surface. If the height is still not enough even when using the included spacers, place a book or the like of suitable thickness underneath.

The maximum load weight of the table is 500 g (1.1 lb.).

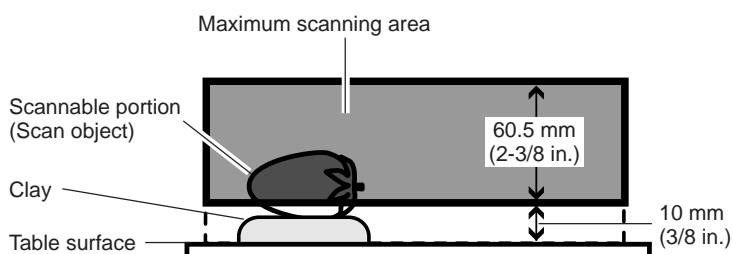

---

### 3) Secure the scan object in place.

1 Make a base on the table using clay.



2 Press the scan object into the clay to hold it in place.

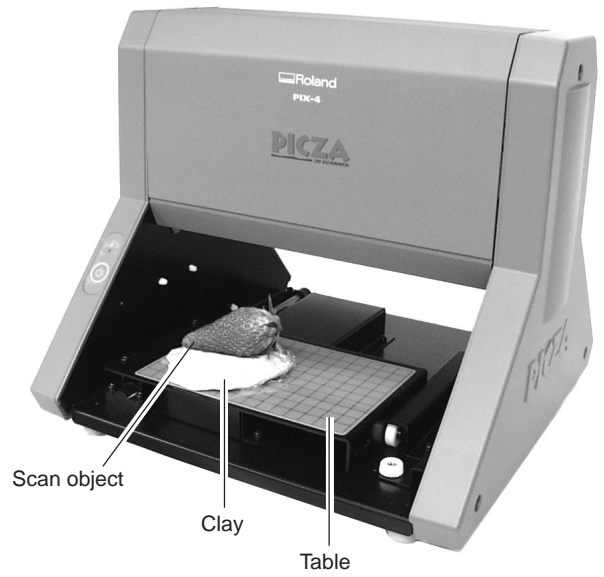

# 9 Starting scanning

## About scanning conditions and the scanning area

For information about the setting items for Dr. PICZA, refer to the figures below.

The grid on the table serves as a guide for mounting the object to scan.

It does not indicate the scanning area for Dr. PICZA.

The scale is in 10-mm (3/8 in.) units.

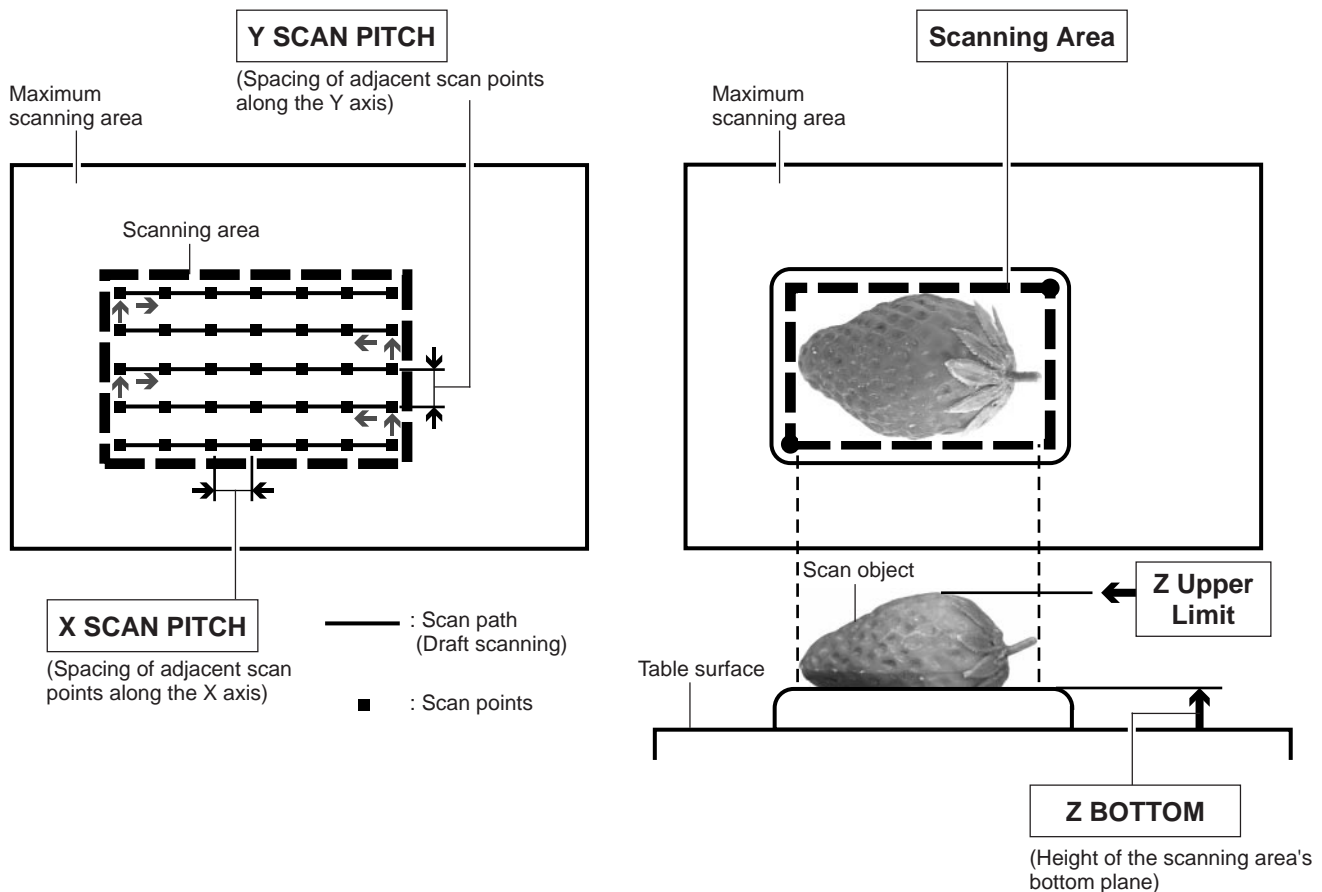

## Setting scanning conditions and starting scanning

### ⚠ CAUTION

**Do not place hands near the main unit while in operation.**  
Doing so may result in injury.  
Doing so may lead to faulty operation or breakdown.

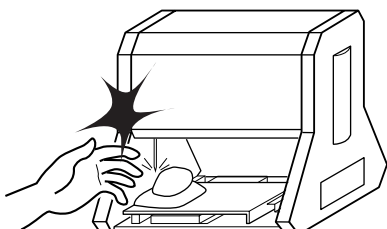

The explanations here and after are based on samples like those shown in the figures.





Make the settings for scanning resolution, the minimum height of the surface to be scanned, and the scanning quality.

- 1 Click  on the Dr. PICZA.

The Controller window opens.  
When Dr. PICZA is started, the Controller window is already open.

**For Dr. PICZA for Mac OS**  
Open the [File] menu and choose [New].

- 2 Make the settings for X scan pitch and Y scan pitch.  
The setting in this example is for 0.50 mm (0.020 in.).
- 3 Make the setting for Z bottom.  
The setting in this example is for 13 mm (0.512 in.).

- 4 Make the selection for scanning quality.  
Here, click [Fine] to activate this setting.

- 5 Here, click [Smart Scan] to activate the setting.  
When the [Smart Scan] setting is on, clicking [Scan] makes the PIX-4 automatically restrict the scanning area (on the X-Y plane only) before scanning is performed.  
To specify the scanning area, turn off [Smart Scan] and refer to "Setting the scanning area" to make the desired settings.

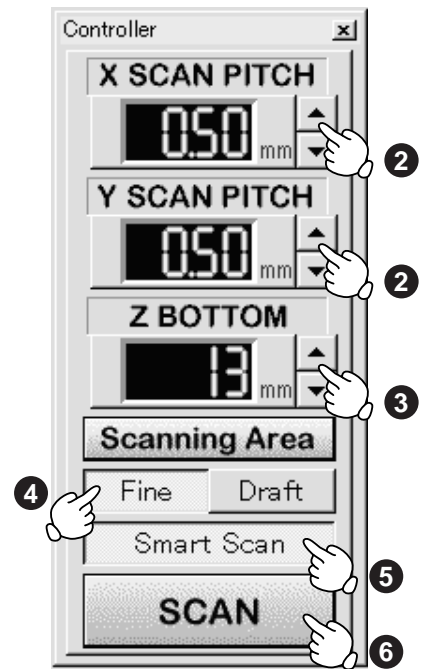

For detailed description of the available Controller buttons, please refer to the help screens for Dr. PICZA.

- 6 Click [SCAN].  
Scanning starts.  
(During scanning, the sensor may emit a transmission sound, but this is normal.)

### If You're Using Windows NT 4.0

If the printer port for Windows driver and the communication port for Dr. PICZA are set to the same port, you cannot use Dr. PICZA. To perform scanning, specify an unused port for the Dr. PICZA communication port.

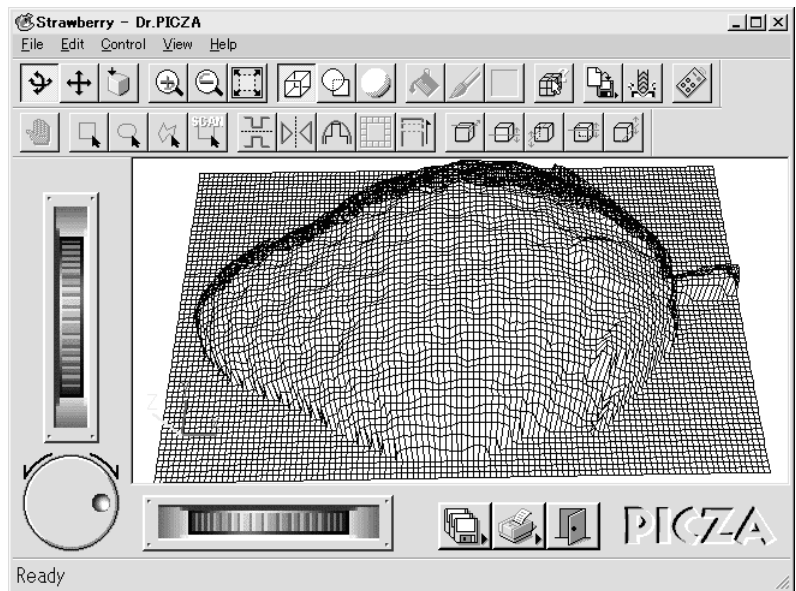

Use the following examples as a guide to determine the amount of computer memory required to perform scanning.

\* The figures shown below are the amounts used by Dr. PICZA alone. They do not take into account the amounts used by the operating system or other programs.

Example: Required memory when scanning a 100 mm x 100 mm (3-15/16 in. x 3-15/16 in.) area

- Scanning at a pitch of 0.05 mm x 0.05 mm (0.002 in. x 0.002 in.) :   Approx. 2 GB
- Scanning at a pitch of 0.1 mm x 0.1 mm (0.004 in. x 0.004 in.) :   Approx. 500 MB
- Scanning at a pitch of 0.5 mm x 0.5 mm (0.020 in. x 0.020 in.) :   Approx. 20 MB

## Setting the scanning area

If you wish to limit the scanning area, such as in cases where you wish to scan only a portion of an object, make the settings as described below.

**1** Click [Scanning Area] in the Controller window. The [Scanning Area] dialog box appears.

**2** Make the settings for the scanning area.

Make the settings to match the location where the scan object is secured in place.

Either of the following two methods can be used to make the settings.

- Use the mouse to move the blue frame on screen. - Enter the numerical values for the upper-right and lower-left points.

The size of the on-screen scanning area (shown in blue) changes to match the values that are entered.

**3** Click [Begin Area Test].

The sensor moves to a position above an outer point on the scanning area that has been set.

Make sure the scan object that has been secured in place lies within the area.

**4** Click [Z Upper Limit].

The cursor  is displayed on the Z upper-limit setting on screen.

Specify the highest position of the scan object. Clicking [Apply] or double-clicking on the target lowers the sensors to the target's center position.

If the target is displaced, redo the settings.

\* Set the Z upper limit to the highest position on the object to be scanned.

During scanning, if the sensor detects a position higher than the Z upper-limit setting, the setting is cleared and scanning continues with the greatest scan height of Dr. PICZA as the Z upper limit.

**5** After determining the scanning area, click [OK].

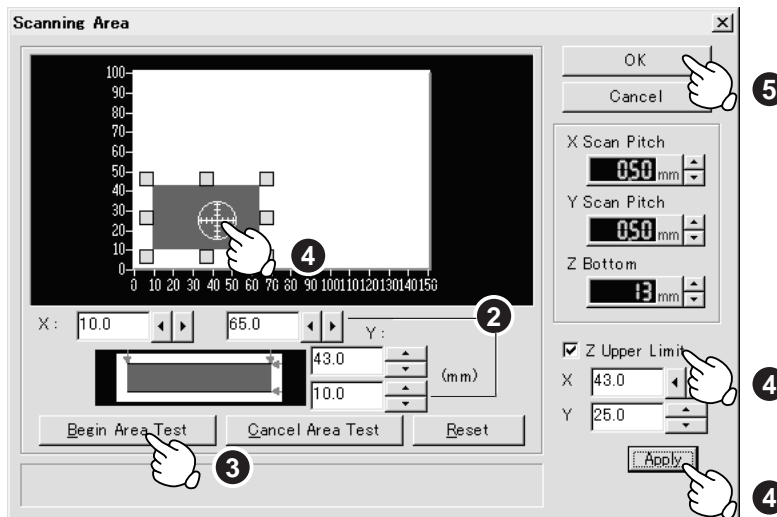

- For the scanning area and Z upper limit, please refer to "About scanning conditions and the scanning area".

- For details about the buttons on the scanning-region setting screen, please refer to the help screens for Dr. PICZA.

**6** Check the scanning conditions in the Controller window one more time, then click [SCAN]. Scanning starts. (During scanning, the sensor may emit a transmission sound, but this is normal.)

## Rescanning a particular portion

After you've scanned an object, you can rescan a particular portion of the object.

After performing coarse scanning for the entire object, respecifying only an included portion and performing fine scanning can shorten the scanning time.

However, if the scan object has been moved or removed from the table, or if the power to the PIX-4 has been switched off and back on, then you cannot scan the same portion.

- 1 Click , and from the scanning data shown on the screen, select a portion to rescan. You can specify a number of noncontinuous portions.

Specify area for rescanning

- 2 Click  on the Dr. PICZA. The Controller window opens.

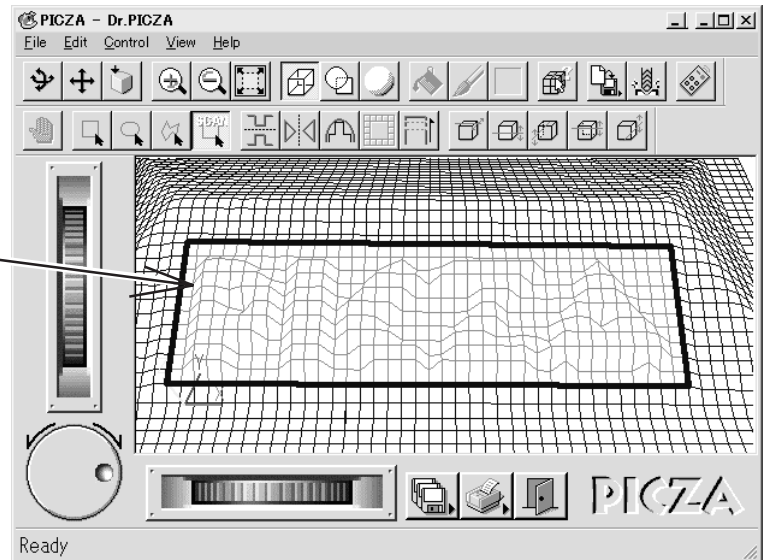

- 3 Make the setting for scanning conditions.
- 4 Click [SCAN]. Rescanning of the specified portion starts.

Results of rescanning

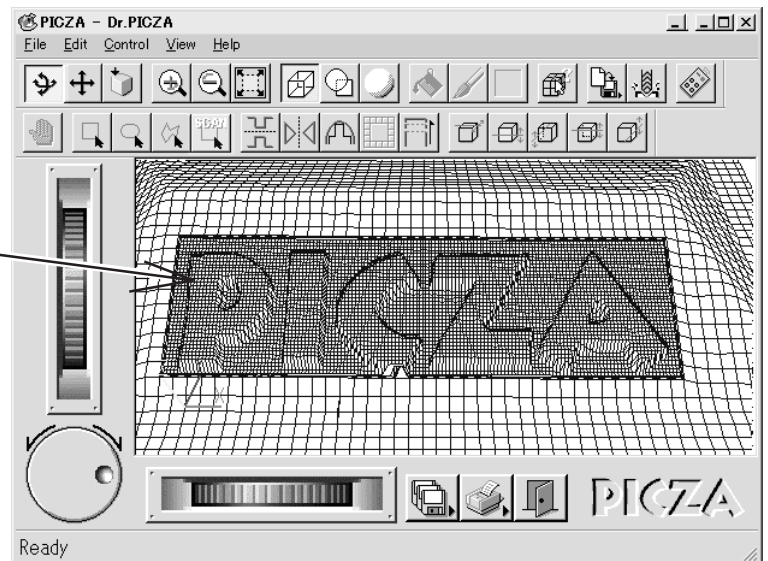

## Cancel scanning/Pauses scanning

Cancel scanning.  
Any data scanned before being canceled remains in memory.

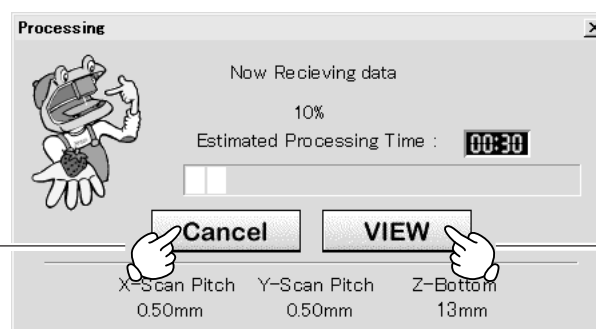

Scanning pauses and the sensor moves to the VIEW position (the inner-right area). Click [VIEW] again to resume scanning.

---

# 10 Saving scanned data

- ① Click  and choose [Save].  
The [Save As] dialog box appears.

( For Dr. PICZA for Mac OS  
Click  and choose [Save]. The dialog appears. )

- ② Choose the desired location for saving the file, enter a file name, and click [SAVE].  
The extension ".pix" is appended to the file name.

For information on how to save a file, please refer to the help screens for Dr. PICZA.

---

## Edit the scanned data

The shape of an object can be edited. It is possible to vary the height, adjust the slant, or perform concave/convex inversion (height inversion) for a desired surface.

You can use the toolbar button or select [Edit] on the menu bar.

Please refer to the help screens for Dr. PICZA for detailed explanations of the various functions that are available.

Be sure to save the scanned data before starting to edit.

When you're done editing, be sure to save your file.

# 11 Powering OFF

## CAUTION



**When not in use for extended periods, unplug the AC adapter from the electrical outlet.**

Failure to do so may result in danger of shock, electrocution, or fire due to deterioration of the electrical insulation.

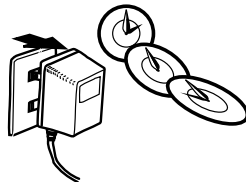

Press the STANDBY key.  
The STANDBY LED goes out.

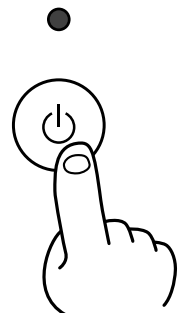

---

## When not in use

- Remove the scan object from the table.
- Remove any clay from table, and store the clay so that it will not dry out.
- Unplug the AC adapter from the electrical outlet.

---

## 12 Ending Dr. PICZA

Click the  button.

## 13 Items that may not be copied

Unauthorized reproduction of a copyrighted item for any purpose other than personal use may be a violation of copyright. Roland DG Corp. will not be responsible for any violation of third-party copyright by any article made through use of this product.

## 14 What to do if...

If you want to completely stop the operation of the PIX-4, detach the AC adapter from AC outlet.

### The PIX-4 doesn't operate

Check the following.

- Is the STANDBY key on (with the STANDBY LED lit up)?
- Are the settings for the computer and software correct?
- Are the cable connected correctly?
- Have the retaining screws and the retainer for the table been removed? (Refer to "3 Setting up and connection".)

### The STANDBY LEDs repeatedly flashes once

This indicates a communications error.

Switch off the power and check the following.

- Are the communications port settings made for Dr. PICZA correct?
- Are the connections for the AC adapter and the cable connecting the unit to the computer secure?
- Are the AC adapter and the cable connecting the unit to the computer free of any internal broken wires?
- Is the operation of the computer correct?
- Was the power to the computer switched on before the PIX-4 was turned on? (Be sure to power up the computer first, then switch on the power to the PIX-4.)
- Was the computer restarted?

When the computer has been restarted, switch the power to the PIX-4 off, wait a few seconds, then switch it back on.

### The STANDBY LEDs repeatedly flashes twice

Something touched the sensor during initial operation immediately after switching on the power, or a hardware error occurred.

If there is an obstruction, then switch off the power, remove the obstruction, and switch the power back on.

If there was a hardware error, then switch the power off and back on and repeat the same operation.

If the same error display occurs, consult your authorized Roland dealer or service center.

### Pressing the STANDBY key does not switch off the power.

Unplug the AC adapter from the unit.

### The tip of the sensor was inadvertently bent

Please contact your authorized Roland DG Corp. dealer or service center.

# 15 Specifications

## Main unit specifications

- Max. scanning area : 152.4 mm (6 in.) [X] x 101.6 mm (4 in.) [Y] x 60.5 mm (2-3/8 in.) [Z]
- Max. table load weight : 500 g (1.1 lb.)
- Sensor : Roland Active Piezo Sensor (R.A.P.S.)  
Probe length 64 mm (2-1/2 in.), tip bulb diameter 0.08 mm (0.00315 in.)
- Scanning method : Contacting, mesh-point height-sensing
- Scanning pitch (Dr. PICZA) : X/Y-axis directions -- 0.05 to 5.00 mm (0.002 in. to 0.20 in.) (settable in steps of 0.05 mm (0.002 in.))  
Z-axis direction -- 0.025 mm (0.000984 in.)
- Scanning speed : X/Y-axis -- 30 mm/sec. (1-1/8 in./sec.) Z-axis -- 9 mm/sec. (5/16 in./sec.)
- Exportable file formats : DXF, VRML, STL, 3DMF, Grayscale, PICT (for Mac OS), BMP (for Windows), and Vertex
- Interface : Serial (RS-232C)
- Control keys : STANDBY key
- LED : STANDBY LED
- Power consumption : Exclusive AC adapter (DC+12V 1.5 A)
- Acoustic noise level : Standby mode: under 31 dB (A)  
Scanning mode: under 41 dB (A) (According to ISO 7779)
- External dimensions : 313 mm (W) x 304 mm (D) x 276 mm (H) (12-3/8 in. (W) x 12 in. (D)) x 10-7/8 in. (H))
- Weight (unit only) : 4.9 kg (10.8 lb.)
- Operation temperature : 5—40°C (41—104°F)
- Operation humidity : 35—80 % (no condensation)
- Accessories : Dr.PICZA for Windows disks: 2, Dr.PICZA for Mac OS disk: 1, AC adapter: 1, clay: 1, PIX-4 user's manual: 1

## Interface Specification

### [Serial]

- Standard : RS-232C specifications
- Transmission method : Asynchronous, duplex data transmission
- Transmission speed : 9600 bps
- Parity Check : None
- Data Bits : 8 bits (fixed)
- Stop Bits : 1 bits (fixed)
- Handshake : Hardwire

## Serial connector (RS-232C)

Signal number	Terminal number	Signal number	Pin connection
NC	25	13	NC
NC	24	12	NC
NC	23	11	NC
NC	22	10	NC
NC	21	9	NC
DTR	20	8	NC
NC	19	7	SG
NC	18	6	DSR
NC	17	5	CTS
NC	16	4	RTS
NC	15	3	RXD
NC	14	2	TXD
	1		FG

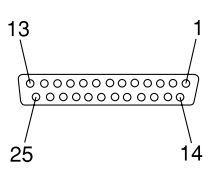

## Serial Cable for Macintosh

Prepare a crossover cable with the following specifications to connect the Macintosh and the PIX-4.

### Crossover serial cable

Mini-DIN 8-pin male connector - D-sub 25-pin male connector  
Apple crossover cable (JCRC01 compliant)

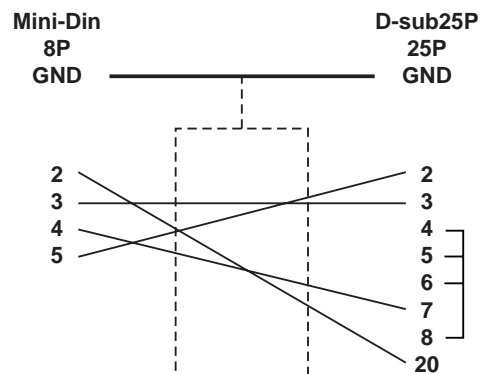

## Please read this agreement carefully before opening the sealed package or the sealed disk package

Opening the sealed package or sealed disk package implies your acceptance of the terms and conditions of this agreement. If you do NOT accept this agreement, retain the package UNOPENED. (This product is just one of included items. Please be aware that any amount of the purchase price will not be refunded for return of this product as a single item, regardless of whether the package is opened or unopened.) The enclosed Roland product is a single user version.

### Roland License Agreement

Roland DG Corporation ("Roland") grants you a non-assignable and non-exclusive right to use the COMPUTER PROGRAMS in this package ("Software") under this agreement with the following terms and conditions.

- 1. Coming into Force**

This agreement comes into force when you purchase and open the sealed package or sealed disk package.  
The effective date of this agreement is the date when you open the sealed package or sealed disk package.
- 2. Property**

Copyright and property of this Software, logo, name, manual and all literature for this Software belong to Roland and its licensor.

The followings are prohibited :

  - (1) Unauthorized copying the Software or any of its support file, program module or literature.
  - (2) Reverse engineering, disassembling, decompiling or any other attempt to discover the source code of the Software.
- 3. Bounds of License**

Roland does not grant you to sub-license, rent, assign or transfer the right granted under this agreement nor the Software itself (including the accompanying items) to any third party.  
You may not provide use of the Software through time-sharing service and/or network system to any third party who is not individually licensed to use this Software.

You may use the Software by one person with using a single computer in which the Software is installed.
- 4. Reproduction**

You may make one copy of the Software only for back-up purpose. The property of the copied Software belongs to Roland.  
You may install the Software into the hard disk of a single computer.
- 5. Cancellation**

Roland retains the right to terminate this agreement without notice immediately when any of followings occurs :

  - (1) When you violate any article of this agreement.
  - (2) When you make any serious breach of faith regarding this agreement.
- 6. Limitations on Liability**

Roland may change the specifications of this Software or its material without notice.

Roland shall not be liable for any damage that may caused by the use of the Software or by exercise of the right licensed by this agreement.
- 7. Governing Law**

This agreement is governed by the laws of Japan, and the parties shall submit to the exclusive jurisdiction of the Japanese Court.