

# **STIKA**

**DESIGN CUTTER**

## **SV-15/12/8**

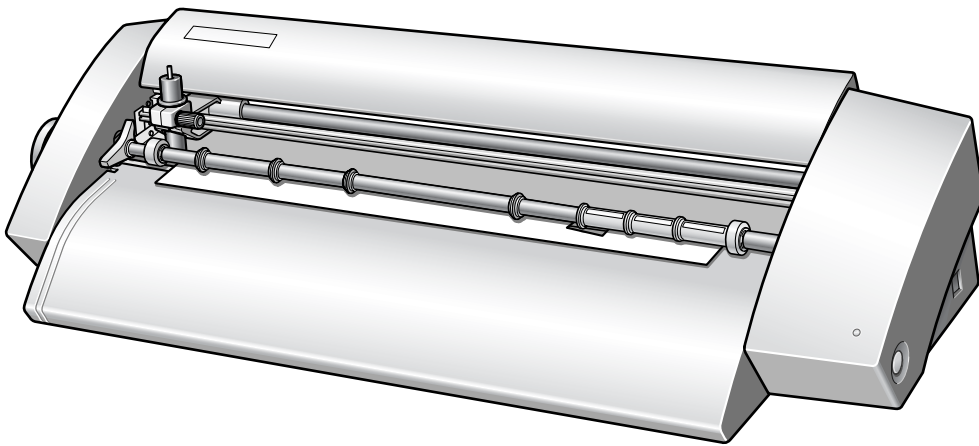

## **USER'S MANUAL**

Thank you very much for purchasing this product.

- To ensure correct and safe usage with a full understanding of this product's performance, please be sure to read through this manual completely and store it in a safe location.
- Unauthorized copying or transferral, in whole or in part, of this manual is prohibited.
- The contents of this operation manual and the specifications of this product are subject to change without notice.
- The operation manual and the product have been prepared and tested as much as possible. If you find any misprint or error, please inform us.
- Roland DG Corp. assumes no responsibility for any direct or indirect loss or damage which may occur through use of this product, regardless of any failure to perform on the part of this product.
- Roland DG Corp. assumes no responsibility for any direct or indirect loss or damage which may occur with respect to any article made using this product.

**For the USA**

**FEDERAL COMMUNICATIONS COMMISSION  
RADIO FREQUENCY INTERFERENCE  
STATEMENT**

This equipment has been tested and found to comply with the limits for a Class A digital device, pursuant to Part 15 of the FCC Rules.

These limits are designed to provide reasonable protection against harmful interference when the equipment is operated in a commercial environment.

This equipment generates, uses, and can radiate radio frequency energy and, if not installed and used in accordance with the instruction manual, may cause harmful interference to radio communications.

Operation of this equipment in a residential area is likely to cause harmful interference in which case the user will be required to correct the interference at his own expense.

---

Unauthorized changes or modification to this system can void the users authority to operate this equipment.

The I/O cables between this equipment and the computing device must be shielded.

**For Canada**

**CLASS A NOTICE**

This Class A digital apparatus meets all requirements of the Canadian Interference-Causing Equipment Regulations.

**CLASSE A AVIS**

Cet appareil numérique de la classe A respecte toutes les exigences du Règlement sur le matériel brouilleur du Canada.

**For California**

**WARNING**

This product contains chemicals known to cause cancer, birth defects and other reproductive harm, including lead.

**For EU Countries**



**Manufacturer:**  
**ROLAND DG CORPORATION**  
1-6-4 Shinmiyakoda, Kita-ku, Hamamatsu-shi, Shizuoka-ken, 431-2103 JAPAN

---

**The authorized representative in the EU:**  
**Roland DG Corporation, German Office Halskestr.7 47877 Willich,Germany**

**For EU Countries**

**WARNING**

This is a Class A product. In a domestic environment this product may cause radio interference in which case the user may be required to take adequate measures.

Roland DG Corp. has licensed the MMP technology from the TPL Group.

# Contents

<b>Read This First</b> .....	<b>3</b>
Machine Functions .....	3
 <b>To Ensure Safe Use</b> .....	<b>6</b>
<b>Important Notes on Handling and Use</b> .....	<b>10</b>
<b>Chapter 1: Setup Preparation</b> .....	<b>11</b>
1-1 Included Items .....	12
1-2 Part Names .....	13
Main Unit .....	13
1-3 Installing.....	14
Deciding On an Installation Site .....	14
Installation Space .....	14
Removing the Packing Materials .....	15
Connecting the Cables .....	16
<b>Chapter 2: Installing Software</b> .....	<b>17</b>
2-1 About the Included Software .....	18
2-2 If You're Using a Windows .....	19
System Requirements .....	19
Installing the Software .....	20
2-3 If You're Using a Macintosh .....	23
System Requirements .....	23
Installing the Software .....	23
<b>Chapter 3: Performing Cutting</b> .....	<b>25</b>
3-1 What to Know Before Cutting .....	26
Useable Material Types .....	26
3-2 Cutting .....	28
Step 1: Load Material .....	28
Step 2: Create Cutting Data .....	30
Step 3: Perform Cutting .....	34
Step 4: Apply the Cut Material .....	36
<b>Chapter 4: Mastering the STIKA</b> .....	<b>37</b>
4-1 Optimizing the Cutting Quality for the Material .....	38
Check the Cutting Quality for the Material .....	38
Adjusting the Blade Extension Amount .....	39
4-2 Correcting the Angle of the Loaded Material .....	40
4-3 About Creating Cutting Data .....	41
Creating Various Text Data .....	41
Creating Contour Data by Reading a BMP/JPG Format File .....	43
Deleting Undesired Cutting Lines .....	45
4-4 Applying Large Materials .....	46

<b>Chapter 5: Maintenance .....</b>	<b>47</b>
<b>5-1 Maintenance .....</b>	<b>48</b>
Cleaning the Blade Tip .....	48
Cleaning the Blade Holder .....	48
Cleaning the Main Unit .....	48
<b>5-2 Replacing Consumables .....</b>	<b>49</b>
Replacing the Blade .....	49
Replacing the Blade Protector .....	50
<b>Chapter 6: Appendix .....</b>	<b>53</b>
<b>6-1 What to Do If .....</b>	<b>54</b>
The machine does not run properly .....	54
The cut incisions are not clean .....	54
Parts of the material are not continuously cut .....	54
The cut location is shifted forward/back .....	54
The cut location is shifted left/right .....	54
The material shifts during cutting .....	55
If the driver cannot be installed .....	55
Uninstalling the driver .....	56
<b>6-2 Shaft Lubrication .....</b>	<b>57</b>
<b>6-3 Cutting Range .....</b>	<b>58</b>
<b>6-4 Locations of the Power Rating and Serial Number Labels .....</b>	<b>59</b>
<b>6-5 Specifications .....</b>	<b>60</b>

CutStudio is a trademark of Roland DG Corp.

Windows® is either a registered trademark or trademark of Microsoft® Corporation in the United States and/or other countries.

Macintosh and Mac OS are registered trademarks or trademarks of Apple Computer, Inc. in the USA and other countries.

Adobe and Adobe Illustrator are either registered trademarks or trademarks of Adobe Systems Incorporated in the United States and/or other countries.

Corel and CorelDRAW are registered trademarks or trademarks of Corel Corporation or Corel Corporation Limited.

Other company names and product names are trademarks or registered trademarks of their respective holders.

# Read This First

## Machine Functions

### For Windows

➤ You can use the included cutting software "Roland CutStudio" to create stickers and stickers with images.

- CutStudio Overview, Installation Method ☞ User's Manual (this document) p 18

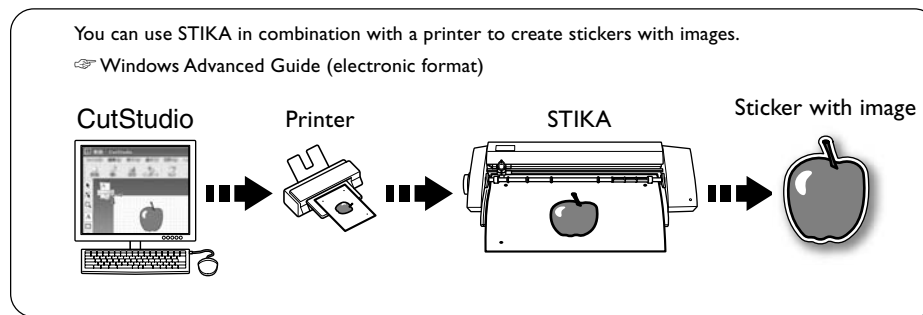

➤ You can use the included Adobe Illustrator software plug-in "CutStudio Plug-in for Adobe Illustrator" to send cutting data created in Illustrator to CutStudio and create stickers and stickers with images.

- Software plug-in overview, installation method ☞ Windows Advanced Guide (electronic format)

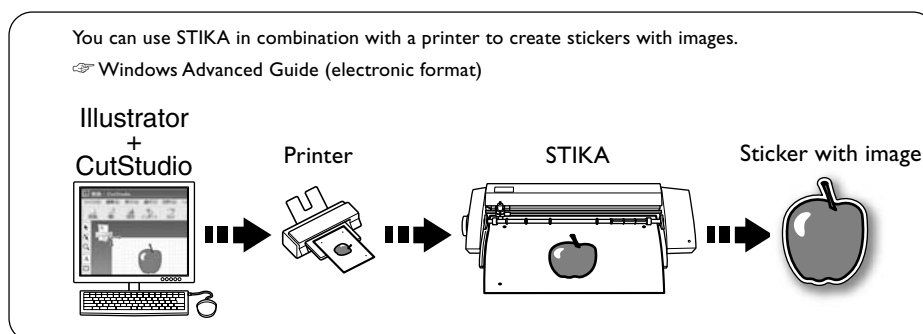
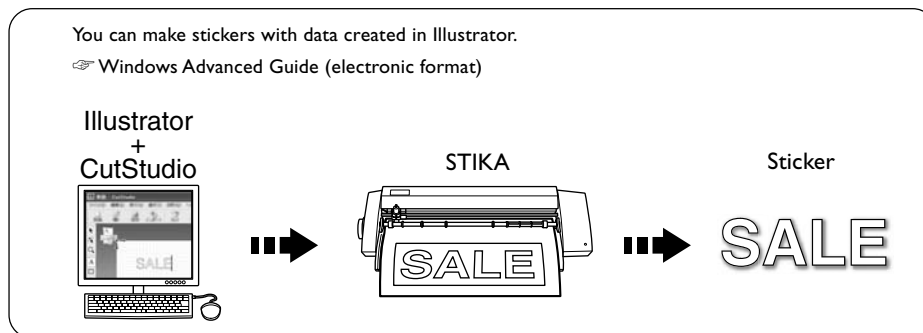

➤ You can use the included CorelDRAW software plug-in "CutStudio Plug-in for CorelDRAW" to send data created in CorelDRAW to CutStudio and create stickers.

- Software plug-in overview, installation method ↗ Windows Advanced Guide (electronic format)

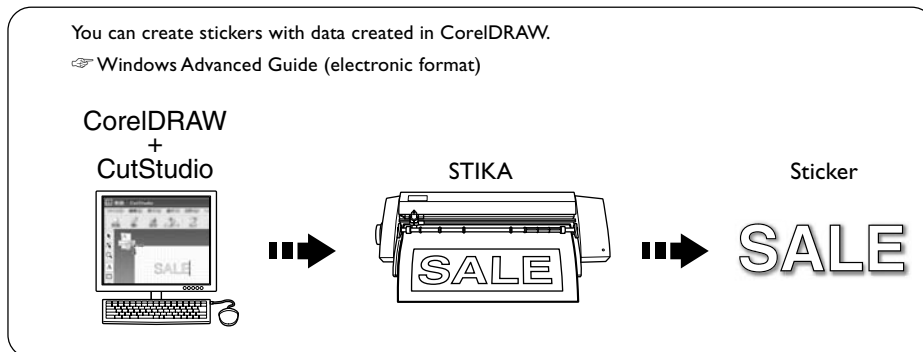

➤ You can use the included software "STIKA Navi" to operate STIKA from your computer. Operation is simple; just follow the instructions displayed on your computer screen.

- STIKA Navi Overview ↗ Windows Advanced Guide (electronic format)

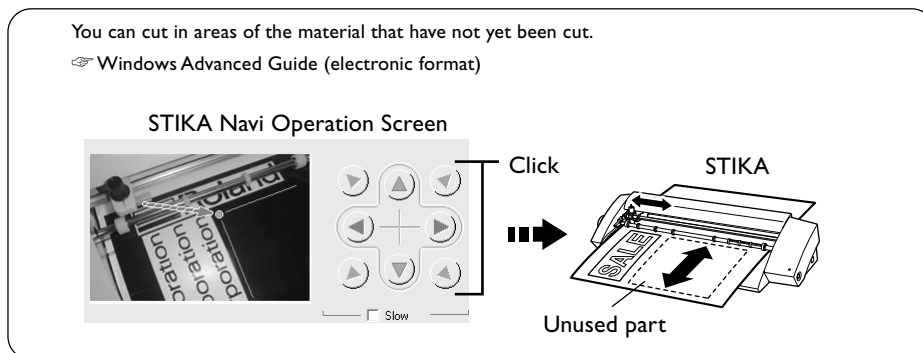
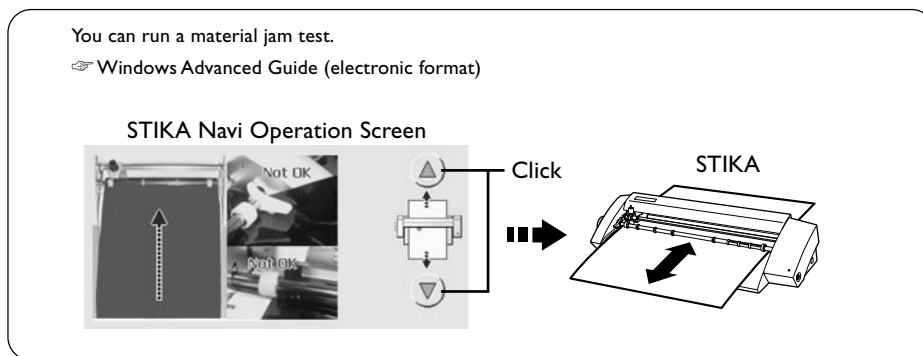

---

## For Macintosh

---

➤ You can use the included software plug-in "CutStudio Plug-in for Adobe Illustrator" to make stickers with data created in Illustrator.

- Software plug-in overview, installation method  User's Manual (this document) p 23

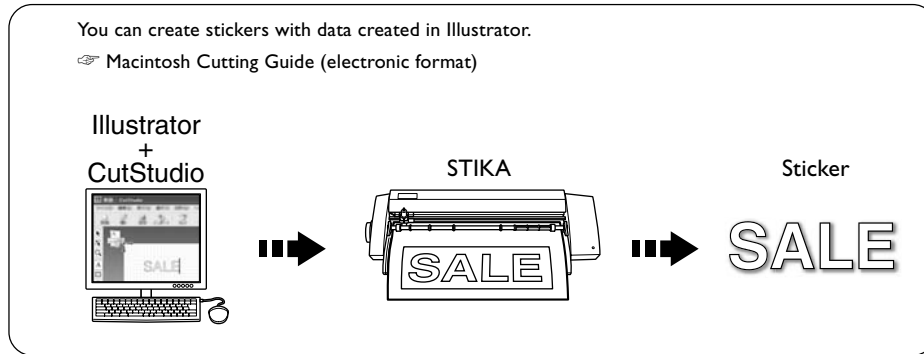







# To Ensure Safe Use

Improper handling or operation of this machine may result in injury or damage to property. Points which must be observed to prevent such injury or damage are described as follows.

## About WARNING and CAUTION Notices

 <b>WARNING</b>	Used for instructions intended to alert the user to the risk of death or severe injury should the unit be used improperly.
 <b>CAUTION</b>	Used for instructions intended to alert the user to the risk of injury or material damage should the unit be used improperly. * Material damage refers to damage or other adverse effects caused with respect to the home and all its furnishings, as well to domestic animals or pets.

## About the Symbols

	The  symbol alerts the user to important instructions or warnings. The specific meaning of the symbol is determined by the design contained within the triangle. The symbol at left means "danger of electrocution."
	The  symbol alerts the user to items that must never be carried out (are forbidden). The specific thing that must not be done is indicated by the design contained within the circle. The symbol at left means the unit must never be disassembled.
	The  symbol alerts the user to things that must be carried out. The specific thing that must be done is indicated by the design contained within the circle. The symbol at left means the power-cord plug must be unplugged from the outlet.



 **Incorrect operation may cause injury**

 **WARNING**



**Keep children away from the machine.**

The machine includes areas and components that pose a hazard to children and may result in injury, blindness, choking, or other serious accident.



**Never attempt to disassemble, repair, or modify the machine.**

Doing so may result in fire, electrical shock, or injury. Entrust repairs to a trained service technician.



**For accessories (optional and consumable items, AC adapter, power cord, and the like), use only genuine articles compatible with this machine.**

Incompatible items may lead to an accident.

 **CAUTION**



**Caution: cutting tool.**

This machine has an internal tool. To avoid injury, handle the tool with care.



**Before attempting cleaning, maintenance, or attachment or detachment of optional items, disconnect the power cord.**

Attempting such operations while the machine is connected to a power source may result in injury or electrical shock.



**Never use the machine for any purpose for which it is not intended, or use the machine in an undue manner that exceeds its capacity.**

Doing so may result in injury or fire.



**Install in a location that is level and stable.**



Installation in an unsuitable location may cause an accident, including a fall or tipover.

 **Danger of electrical short, shock, electrocution, or fire**



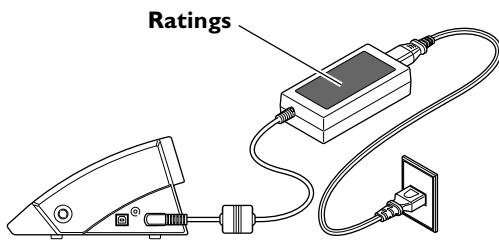

 **WARNING**

-  **Connect to an electrical outlet that complies with this machine's ratings (for voltage, frequency, and current).**  
Incorrect voltage or insufficient current may cause fire or electrical shock.



-  **Never use out of doors or in any location where exposure to water or high humidity may occur. Never touch with wet hands.**  
Doing so may result in fire or electrical shock.
-  **Never allow any foreign object to get inside. Never expose to liquid spills.**  
Inserting objects such as coins or matches or allowing beverages to be spilled into the ventilation ports may result in fire or electrical shock. If anything gets inside, immediately disconnect the power cord and contact your authorized Roland DG Corp. dealer.
-  **Never place any flammable object nearby. Never use a combustible aerosol spray nearby. Never use in any location where gases can accumulate.**  
Combustion or explosion may be a danger.

 **WARNING**

-  **Handle the power cord, plug, and electrical outlet correctly and with care. Never use any article that is damaged.**  
Using a damaged article may result in fire or electrical shock.
-  **When using an extension cord or power strip, use one that adequately satisfies the machine's ratings (for voltage, frequency, and current).**  
Use of multiple electrical loads on a single electrical outlet or of a lengthy extension cord may cause fire.
-  **When the machine will be out of use for a prolonged period, disconnect the power cord.**  
This can prevent accidents in the event of current leakage or unintended startup.
-  **Position so that the power plug is within immediate reach at all times.**  
This is to enable quick disconnection of the power plug in the event of an emergency. Install the machine next to an electrical outlet. Also, provide enough empty space to allow immediate access to the electrical outlet.
-  **If sparking, smoke, burning odor, unusual sound, or abnormal operation occurs, immediately unplug the power cord. Never use if any component is damaged.**  
Continuing to use the machine may result in fire, electrical shock, or injury. Contact your authorized Roland DG Corp. dealer.

⚠ Important notes about the power cord, plug, and electrical outlet

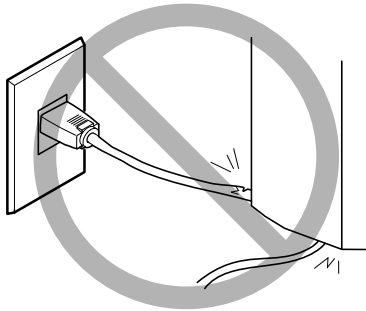

**Never place any object on top or subject to damage.**

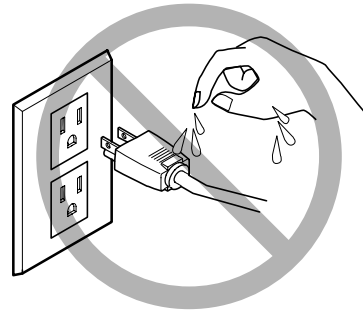

**Never allow to get wet.**

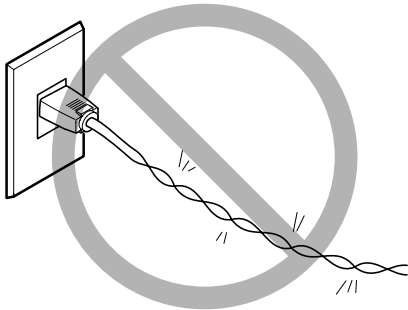

**Never bend or twist with undue force.**

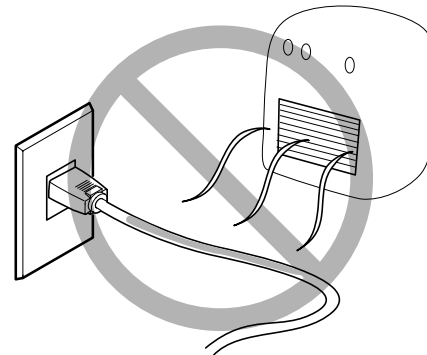

**Never make hot.**

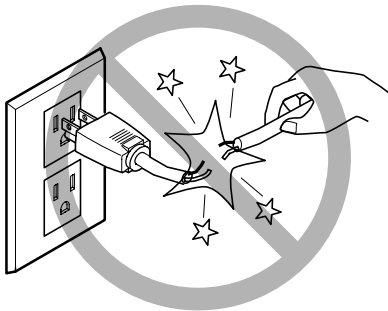

**Never pull with undue force.**

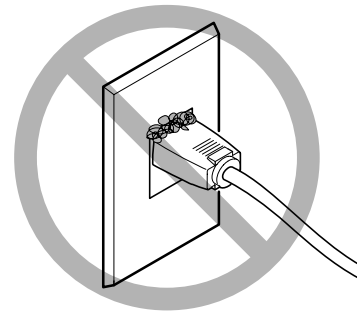

**Dust may cause fire.**

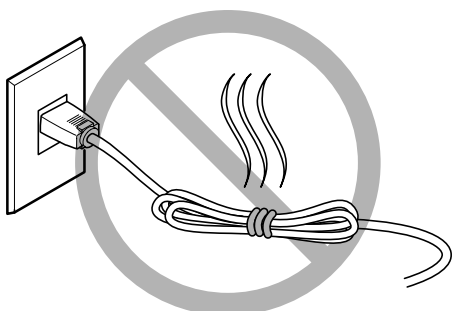

**Never bundle, bind, or roll up.**

# Important Notes on Handling and Use

This machine is a precision device. To ensure the full performance of this machine, be sure to observe the following important points. Failure to observe these may not only result in loss of performance, but may also cause malfunction or breakdown.

## Main Unit

### *This Machine Is a Precision Device*

---

---

- Handle carefully, and never subject the machine to impact or excessive force.

### *Install in a Suitable Location*

---

---

- Install in a location having the specified temperature and relative humidity.
- Install in a stable location offering good operating conditions.

### *Important Notes on Connecting the Cables*

---

---

- Connect the power cord and the computer's input and output cables securely.

### *When Moving the Machine*

---

---

- When moving the machine, be sure to support the machine at its bottom, using both hands. Attempting to move the machine by holding it at a different location may damage the machine.

# ***Chapter 1:*** ***Setup Preparation***

---

# I-I Included Items

The following items are packed together with the unit. Make sure they are all present and accounted for.

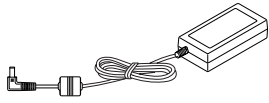

AC adapter: 1



Power cord: 1



USB cable: 1

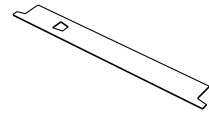

Replaceable blade protector: 1

\* The shape depends on the model.



Blade: 1

\* The blade, blade holder and pin are installed onto the machine.

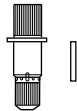

Blade holder: 1  
Pin: 1

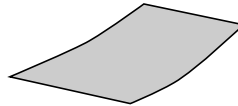

Test-use material  
(Colored material): 1

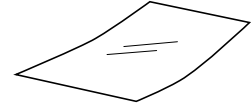

Test-use application tape  
(Transparent tape): 1

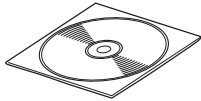

CD-ROM: 1

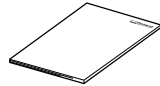

User's Manual: 1

# I-2 Part Names

## Main Unit

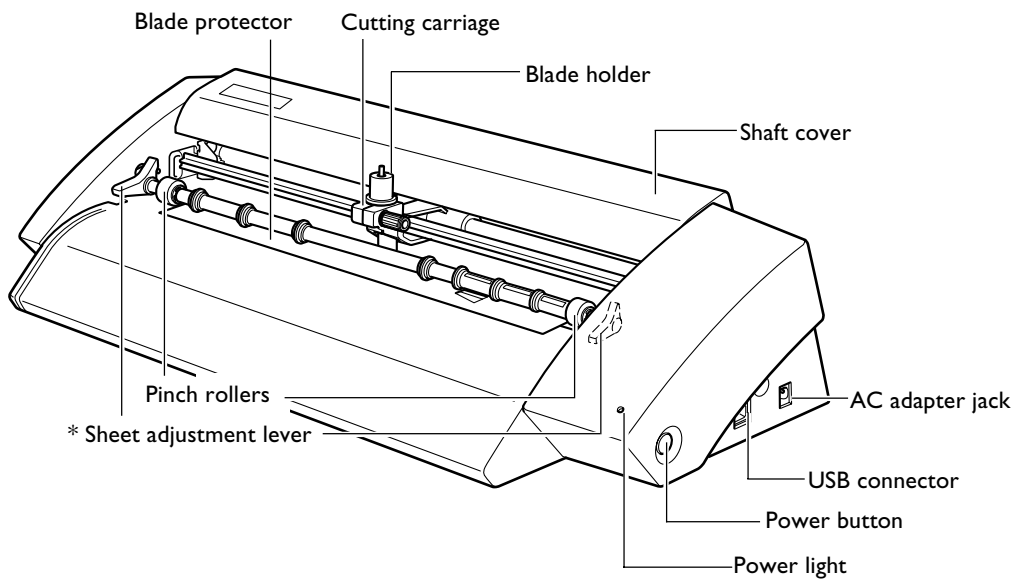

\* The SV-15 has sheet adjustment levers on the left and right. The SV-12/8 has a sheet adjustment lever only on the right.

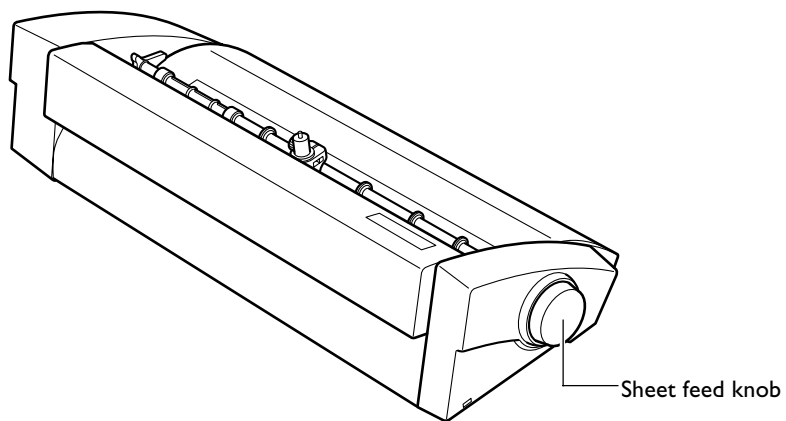

# I-3 Installing

## Deciding On an Installation Site

Install in a stable location offering good operating conditions. An unsuitable location can cause accident, faulty operation, or breakdown.

**⚠ WARNING** Never use out of doors or in any location where exposure to water or high humidity may occur. Never touch with wet hands. Doing so may result in fire or electrical shock.

**⚠ WARNING** Never place any flammable object nearby. Never use a combustible aerosol spray nearby. Never use in any location where gases can accumulate. Combustion or explosion may be a danger.

**⚠ WARNING** Position so that the power plug is within immediate reach at all times. This is to enable quick disconnection of the power plug in the event of an emergency. Install the machine next to an electrical outlet. Also, provide enough empty space to allow immediate access to the electrical outlet.

**⚠ CAUTION** Install in a location that is level and stable. Installation in an unsuitable location may cause an accident, including a fall or tipover.

### Unsuitable Installation Sites

- Locations subject to shaking or vibration
- Locations where the floor is tilted, not level, or unstable
- Dusty locations
- Locations exposed to considerable electrical or magnetic noise, or other forms of electromagnetic energy
- Locations with poor heat radiation

## Installation Space

The material moves forward and backward during cutting. Do not place any objects in front of or behind the material. Make sure that there are no obstructions (such as a wall, etc.) behind the machine.

Leave enough space so that no objects touch the sheet feed knob.

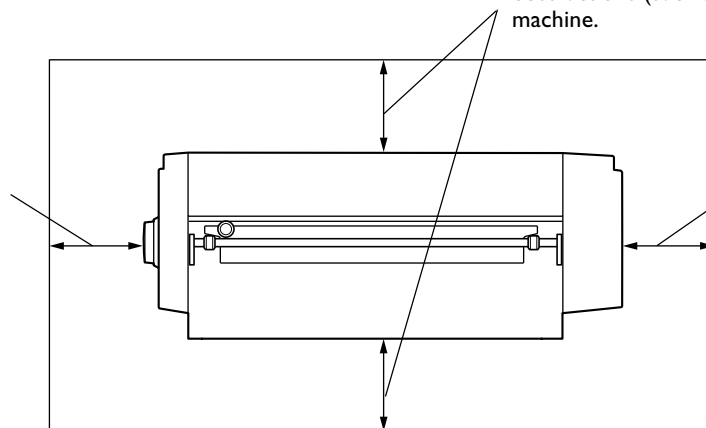

Leave enough space so that the power cord can always be reached.



## Removing the Packing Materials

Tape and packing materials are attached to the machine to protect it from shocks during transportation. When installation is complete, remove these materials.

- Remove all packing materials. Any that remain may cause faulty operation or breakdown when the power is switched on.

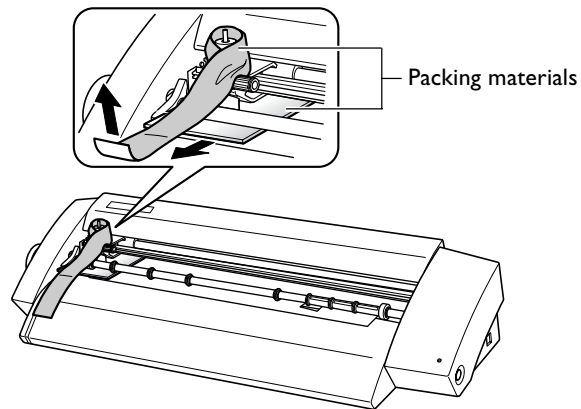

## Connecting the Cables

- ⚠ WARNING** Connect to an electrical outlet that complies with this machine's ratings (for voltage, frequency, and current).  
Incorrect voltage or insufficient current may cause fire or electrical shock.
- ⚠ WARNING** Handle the power cord, plug, and electrical outlet correctly and with care. Never use any article that is damaged.  
Using a damaged article may result in fire or electrical shock.
- ⚠ WARNING** When using an extension cord or power strip, use one that adequately satisfies the machine's ratings (for voltage, frequency, and current).  
Use of multiple electrical loads on a single electrical outlet or of a lengthy extension cord may cause fire.
- ⚠ WARNING** Use only brand-name AC adapters and power cords compatible with this machine.  
The use of an incompatible product could lead to an accident.

**DO NOT connect a USB cable at this point.**

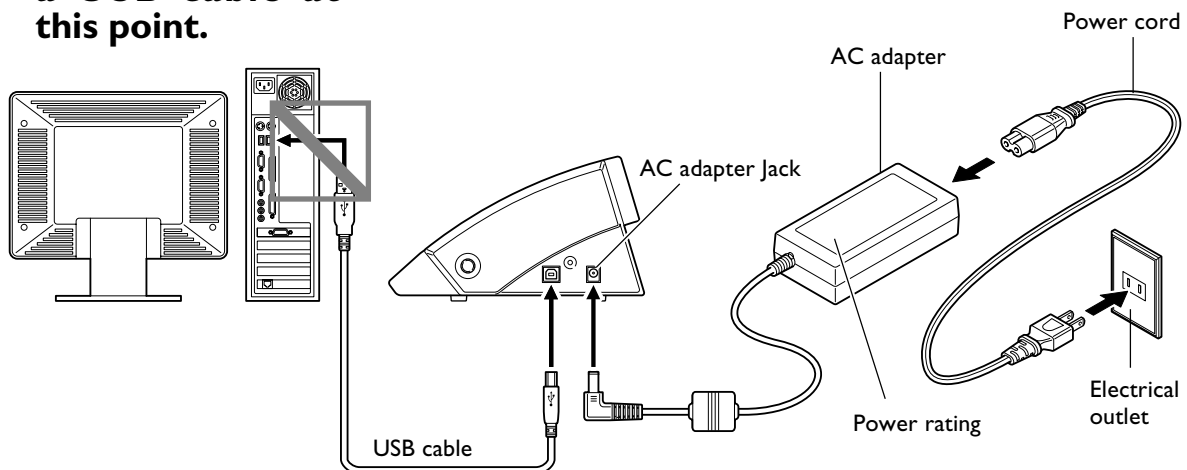

You make the connection to the computer using the included USB cable. Connect the USB cable at the time indicated in the driver installation procedures. Driver installation may fail and the machine may become unusable if you connect a USB cable before starting installing the driver.

☞ p 20 "Installing the Driver"

### Important Notes on USB Connection

- Never use a USB hub or the like.

# ***Chapter 2:***

# ***Installing Software***

---

This section describes how to install the included software.

# 2-1 About the Included Software

---

The included CD-ROM contains the following software.

---

## Software for Windows

---

### ■ STIKA Driver

This is a Windows-based driver required for sending data from a computer to the machine. Be sure to install it.

### ■ STIKA Navi

This is software that lets you operate the machine from Windows. It can be used to move the blade and test the material feed. It is automatically installed when the STIKA driver is installed.

### ■ Roland CutStudio

Roland CutStudio is software that allows you to create cutting data and easily perform cutting operations.

### ■ CutStudio Plug-in for Adobe Illustrator

This is an Illustrator software plug-in that lets you cut from data created in Adobe Illustrator.

### ■ CutStudio Plug-in for CorelDRAW

This is a CorelDRAW software plug-in that lets you cut from data created in CorelDRAW.

---

## Software for Macintosh

---

### ■ CutStudio Plug-in for Adobe Illustrator

This is an Illustrator software plug-in that lets you cut from data created in Adobe Illustrator.

## 2-2 If You're Using a Windows

### System Requirements

#### System Requirements for USB Connection

Making a USB connection with Windows requires use of a computer that meets all of the following system requirements. Please note that other configurations cannot be supported.

Operating Systems	Windows 98 SE (Second Edition)/Me/2000/XP
Computer	1) Computers preinstalled with Windows 98 SE/Me/2000/XP at the time of purchase (This includes such computers later upgraded to Windows Me/2000/XP.) 2) Computers on which USB operation is assured by the manufacturer of computers

#### System Requirements for the Roland CutStudio

Operating Systems	Windows 98 SE (Second Edition)/Me/2000/XP
Computer	Computer running Windows
Drive	CD-ROM drive
Monitor	Windows-compatible monitor capable of displaying of 16 bit color (High Color) or more
Memory (RAM)	128 MB or more recommended
Free hard-disk space required for installation	10 MB

#### System Requirements for the STIKA Driver

Operating Systems	Windows 98 SE (Second Edition)/Me/2000/XP
Computer	1) Computers preinstalled with Windows 98 SE/Me/2000/XP at the time of purchase (This includes such computers later upgraded to Windows Me/2000/XP.) 2) Computers on which USB operation is assured by the manufacturer of computers

## Installing the Software

### Installing the Driver

STIKA Navi is installed along with the driver.

### **Do Not Connect to Computer Until Instructed**

Do not connect the machine to the computer until instructed to do so. Failure to follow the correct procedure may make installation impossible.

☞ p 54 "What to Do If"

### Procedure

- 1 Before you start installation and setup, make sure the USB cable is not connected.
- 2 Log on to Windows. If you are installing under Windows 2000/XP, log on as "Administrators" right.

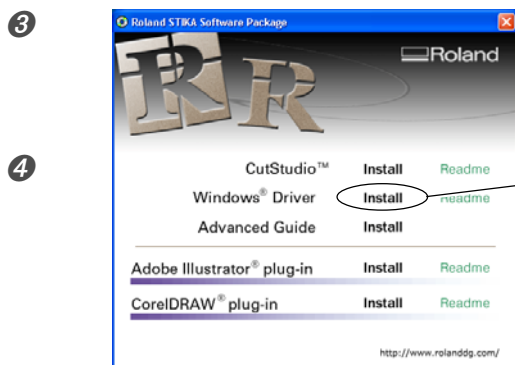

Insert the included CD-ROM into the CD-ROM drive. After a short wait, the setup menu shown at left appears.

Click [Install].

The Installation and Setup Guide appears.

If you're using Windows 98 SE, Windows Me, or Windows 2000, the Installation and Setup Guide and the Setup program appear.

- 5 Follow the instructions in the Installation and Setup Guide to finish installing.



Installation and Setup Guide

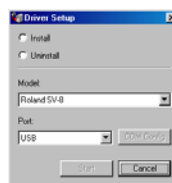

Setup program (Windows 98 SE/Me/2000)

### **If the [Driver Setup] Window Doesn't Appear**

If you're using Windows 98 SE, Windows Me, or Windows 2000 and the Setup program doesn't appear, first check the taskbar at the bottom of the screen. If [Driver Setup] is displayed, the program is running. Go to the taskbar and click [Driver Setup] to display the window for the Setup program.

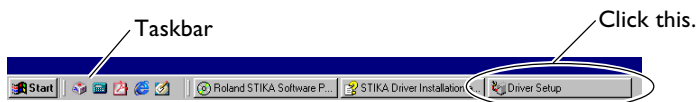

## Installing CutStudio

Install the cutting software "CutStudio."

### Procedure

1

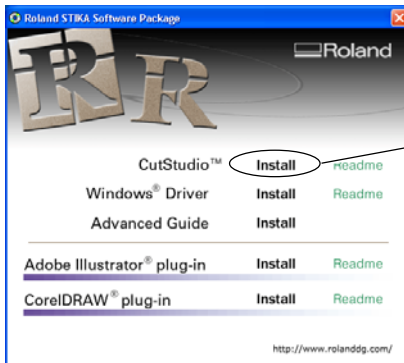

Display the setup menu of the Roland STIKA Software Package.

2

Click [Install].  
The setup window appears.

3 Thereafter, follow the instructions in the messages to complete installation and setup.

Next, you install the Windows Advanced Guide.

### Viewing the Roland CutStudio Online Help

Click [Start], point to [All Programs] (or [Programs]), then point to [Roland CutStudio], point to [CutStudio Help].

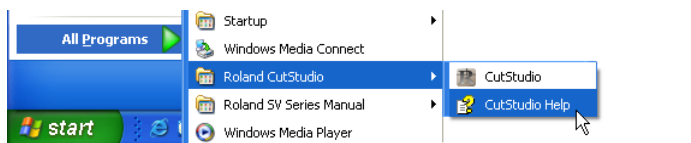

\* You can also display the Online Help from the CutStudio menu.

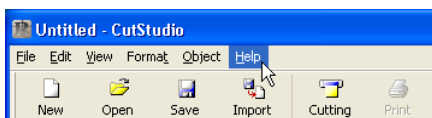

---

## Installing the Windows Advanced Guide

---

### Procedure

---

1

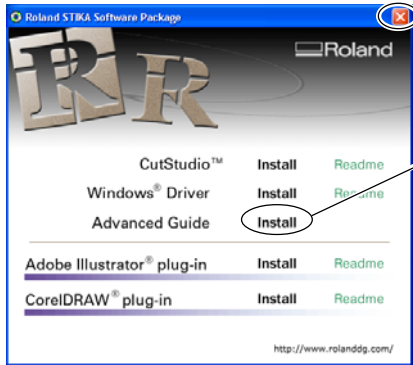

Display the setup menu of the Roland STIKA Software Package.

2

Click [Install].  
The setup window appears.

3 Thereafter, follow the instructions in the messages to complete installation and setup.

4 At the setup menu, go to the upper right and click the [X] to close the window.

---

### Viewing the Windows Advanced Guide

---

Click [Start], point to [All Programs] (or [Programs]), then point to [Roland SV Series Manual], point to [Advanced Guide].

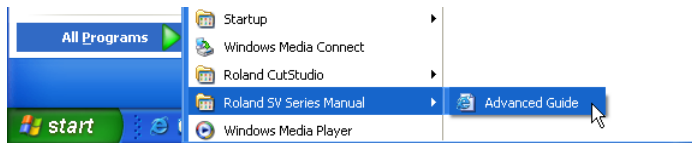

---

### Installing CutStudio Plug-in

---

For information about installing the CutStudio Plug-in, refer to the "Windows Advanced Guide" (electronic format).



# 2-3 If You're Using a Macintosh

## System Requirements

Your Macintosh must fulfill the following requirements in order to use STIKA for cutting operations.  
OS: Mac OS 9 or later (Adobe Illustrator 9/10/CS run without problem)

## Installing the Software

The included CD-ROM contains the "Mac OS Installation and Setup Guide," which explains how to install and set up the software and Macintosh Cutting Guide. If you're using a Macintosh, follow the steps below to display the file, then follow the explanation to perform installation and setup.

### Procedure

- 1 Insert the included CD-ROM into the CD-ROM drive.
- 2 Double-click the [Roland SV Series] icon that appears on the desktop.
- 3 Double-click the "Install\_e.html" icon.

The [Mac OS Installation and Setup Guide] appears.



- 4 Thereafter, follow the instructions in the [Mac OS Installation and Setup Guide] to install and set up the software and Macintosh Cutting Guide.



# ***Chapter 3:***

## ***Performing Cutting***

---

This describes basic cutting operations under Windows. For other operations not covered in this chapter, refer to the "Windows Advanced Guide" (electronic format).

# 3-1 What to Know Before Cutting

## Useable Material Types

The following materials can be used with this machine.

	SV-15	SV-12	SV-8
Size	Width: 360 to 381 mm (14-1/8 to 15 in.) 280 to 305 mm (11 to 12 in.) (A3 length, A4 width) Length: 1100 mm (43-1/4 in.) or less	Width: 280 to 305 mm (11 to 12 in.) (A3 length, A4 width) Length: 1100 mm (43-1/4 in.) or less	Width: 200 to 215 mm (7-13/16 to 8-7/16 in.) (A4 length) Length: 1100 mm (43-1/4 in.) or less
Material Types (*)	Vinyl chloride material (material section thickness is 0.1 mm or less, thickness including the backing paper is 0.3 mm (0.012 in.) or less) Label paper (Thickness including backing paper is 0.3 mm (0.012 in.) or less)		

\* The machine may not cut certain materials.

➤ Do not use material that is in a condition indicated below. It may come loose or jam during cutting.

The material is curled upward.



The material edge is not straight



The left and right edges of the material aren't parallel



The material is longer than 1100 mm (43-1/4 in.)



### Using Roll Material

If you're using a roll of material, make sure to add a margin greater than 40 mm (1-5/8 in.) to the cutting area prior to cutting the material from the roll. Material with a maximum length of 1100 mm (43-1/4 in.) can be loaded into the machine. However, the cutting area is only 1000 mm (39-5/16 in.).

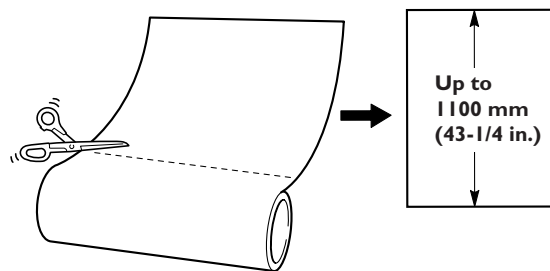

➤ Cut the material at a right angle. If the front edge of the material is uneven, it may feed improperly during cutting and could skew diagonally and come loose.

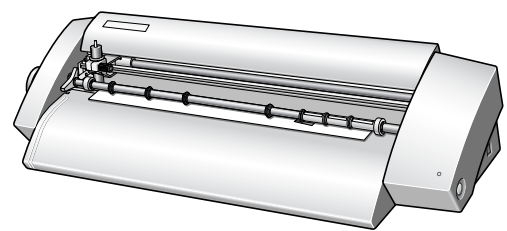

## 3-2 Cutting

Let's look at the basic cutting method while creating the sticker indicated to the right. Follow the operations in the order indicated below.

# SALE

### Step I: Load Material

#### Procedure

1 Turn the machine off.

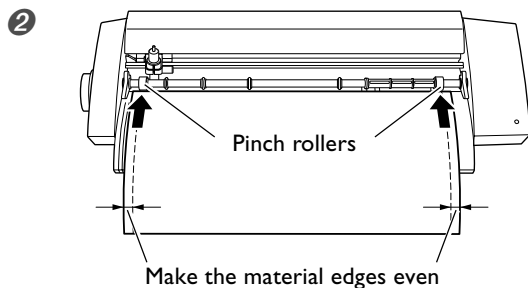

Verify that the material is narrow enough to be loaded and that it touches the pinch rollers.

If you are using the SV-15 model, adjust the pinch rollers to the material width and then advance the material to touch the pinch rollers.

☞ p 29 "Changing Loadable Material Width (for SV-15)"

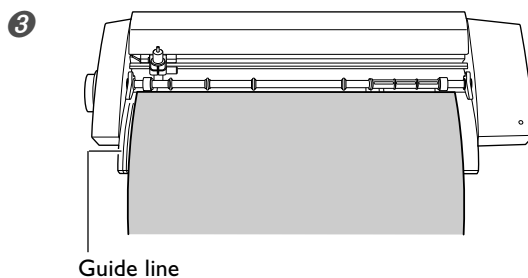

Verify that the left edge of the material is parallel with the guide line.

\* If it is not, trim the excess material from the edge of the material that is touching the pinch rollers until the left edge is parallel with the guide line.

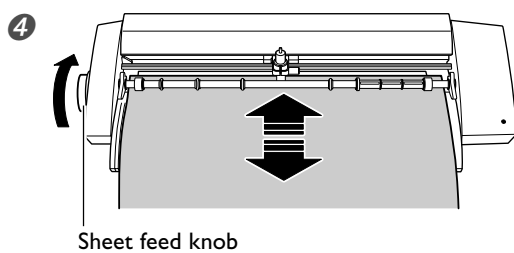

Turn the sheet feed knob and move the material into the machine and then back out. Verify that the material does not come loose.

\* Reload the material if it becomes skewed or if it comes loose.

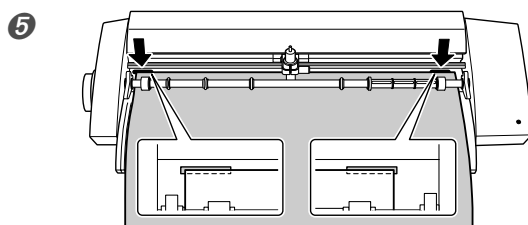

Align the material edge with the marks at the back of the blade protector.

#### Loading the Included Test-use Material

The direction to load the included test-use material differs depending on the machine model.

SV-15/12 ... Sideways (Landscape)    SV-8 ... Lengthwise (Portrait)

If you are using the SV-15 model, change the loadable material width to 280 to 305 mm (11 to 12 in.).

☞ p 29 "Changing Loadable Material Width (for SV-15)"

### Changing Loadable Material Width (for SV-15)

In the SV-15 model, you can change the loadable material width to match the material being loaded (360 to 381 mm (14-1/8 to 15 in.) or 280 to 305 mm (11 to 12 in.)). Change the pinch roller location and driver settings to change the width.

1

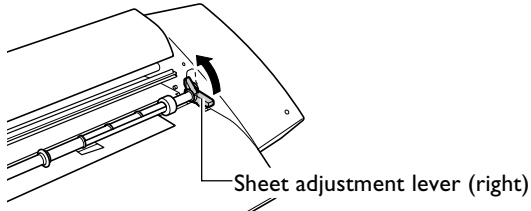

Raise the sheet adjustment lever on the right side.

2

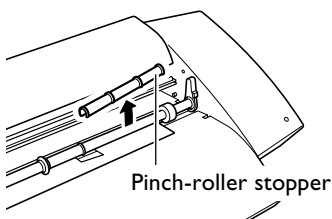

Remove the pinch-roller stopper.

Do not use excessive force to widen the opening when removing the pinch-roller stopper. If the opening is widened, the stopper may become loose and fall out when it is next attached to the unit.

3 Move the right side pinch roller to match the width of the material being loaded and attach the pinch-roller stopper.

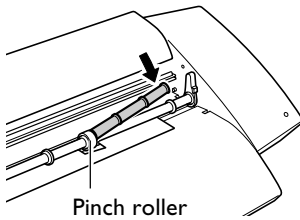

For 280 to 305 mm (11 to 12 in.)

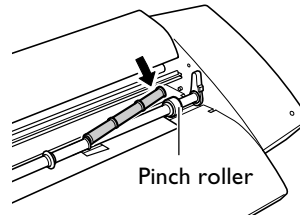

For 360 to 381 mm (14-1/8 to 15 in.)

4

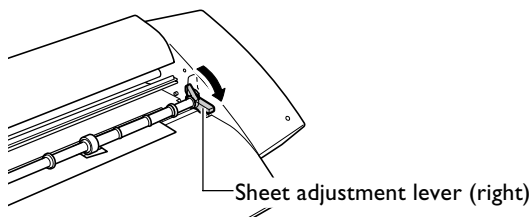

Lower the sheet adjustment lever on the right side.

5 Load material.

☞ p 28 "Step 1: Load Material"

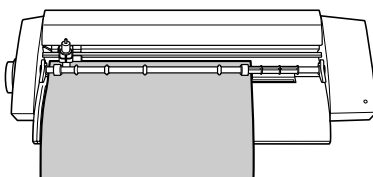

For 280 to 305 mm (11 to 12 in.)

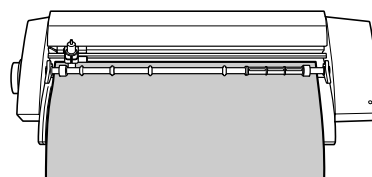

For 360 to 381 mm (14-1/8 to 15 in.)

6 Change the driver cutting area to match the size of the loaded material.

☞ Procedures 1 and 2 on page 30 "Step 2: Creating Cutting Data"

## Step 2: Create Cutting Data

Use the cutting software "CutStudio" to create cutting data.  
 Refer to "Roland CutStudio Online Help" for a detailed explanation of CutStudio operations and features.

> If you are using Windows 2000/XP, log on to Windows as "Administrator" right.

### 1. Start CutStudio.

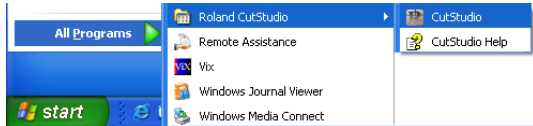

Click [Start].  
 Point to [All Programs] (or [Program]) – [Roland CutStudio], then click [CutStudio].

### 2. Make the settings for the cutting range.

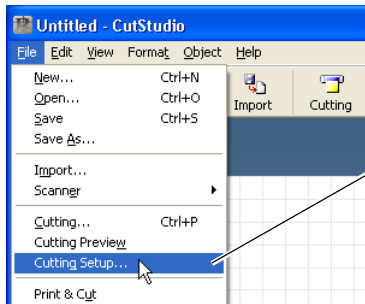

**1** Click [File], then click [Cutting Setup].  
 The [Cutting Setup] screen appears.

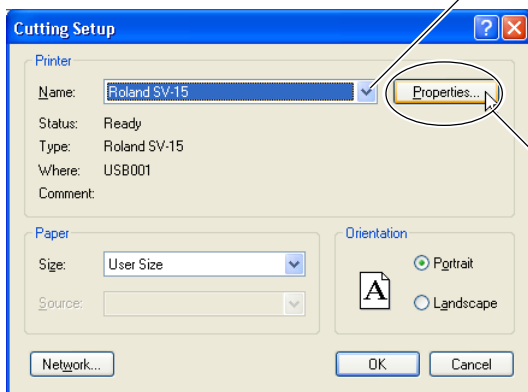

**2** Select the name of the model you are using under [Name].

**3** Click [Properties].  
 The [Properties] screen appears.



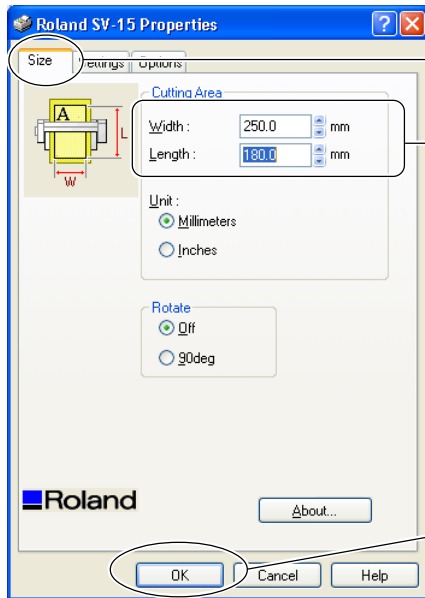

4 Click the [Size] tab.

5 Set the cutting range to match the loaded material size.

For the width, click [mm] to select either 250 (9.84 in.) or 340 mm (13.39 in.) (SV-15 only).

(\* Set to 250 mm (9.84 in.) if you are using the included test-use material.)

The width cannot be changed on the SV-12/8 models.

For the length, set a range that subtracts the margin from the loaded material length.

➔ p 58 "Cutting Range"

6 Click [OK].

7 Click [OK] again to close the [Cutting Setup] screen.

The cutting range has now been set.

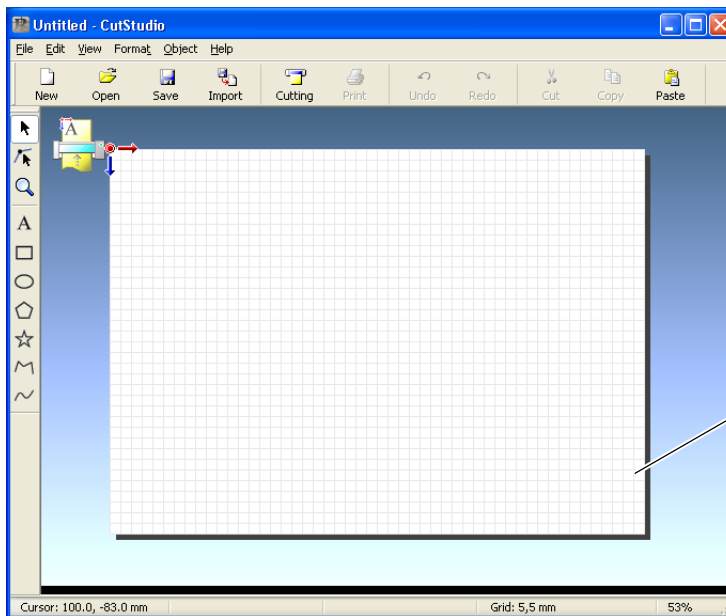

The white area is the cutting range. Text or shapes drawn outside this range are not cut.

### 3. Insert text and shapes to create the cutting data.

In this example, we'll enter the word "SALE" as the text and draw a frame around it to make it easier to peel off later.

1

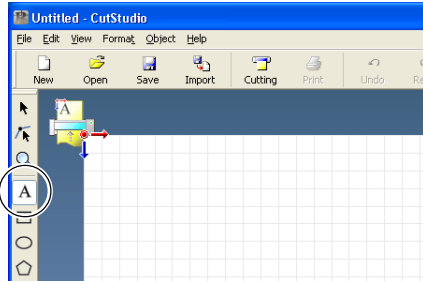

Click [  ].

2

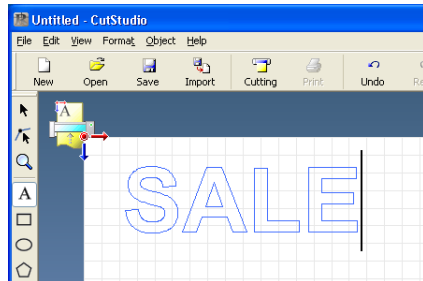

Click anywhere in the white area, then type in "SALE."

3

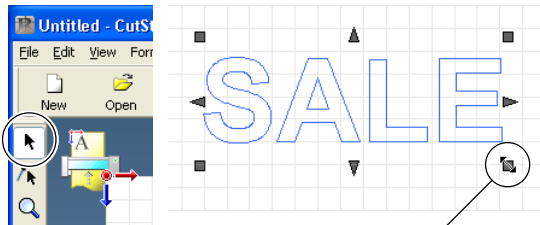

Click [  ].  
Displayed around the text are ■ and ▼ symbols.  
Drag the ■ and ▼ symbols for the text box to change the size of the text.

Click, then drag to change to the required size.

4

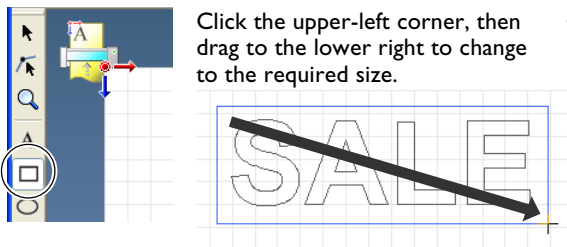

Click [  ].  
Draw a rectangle around the "SALE" text.

5

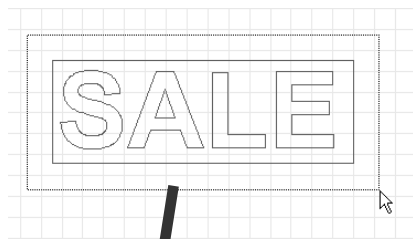

Click [  ].

Use the mouse to select an area containing the text and the rectangle.

When you select this, the line turns blue.

Move the position to the top of the window, near the origin point.

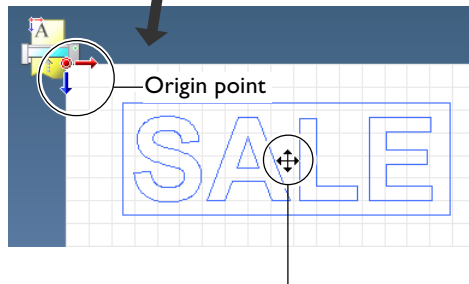

Move the pointer to inside the text. When the shape of the pointer changes to a cross, drag to move.

6

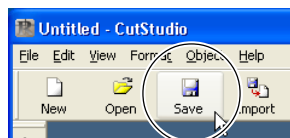

Click [Save].

The [Save As] screen appears.

7

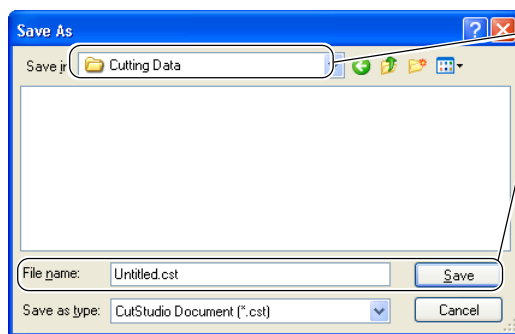

For "Save in," choose the folder you want.

Enter the file name, then click [Save].

The data you created is saved.

### **Important Note When Saving Data**

The cutting range set in [File] – [Cutting Setup] – [Properties] is not saved. The next time you import data, go to the [Cutting Setup] menu and redo the setting for the cutting range.

## Step 3: Perform Cutting

Before cutting, verify that Step 1 "Load Material" and Step 2 "Create Cutting Data" preparation have been completed.

### Procedure

1

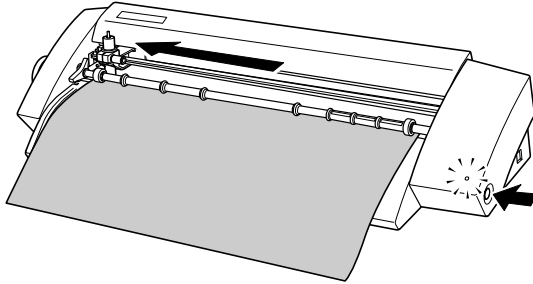

Press the power button and turn the machine on.

The power light flashes. The cutting carriage moves to the left edge of the machine. Once the light changes to a steady illumination, the machine is ready to cut.

2

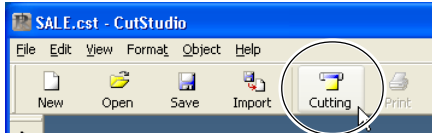

Click [Cutting].

3

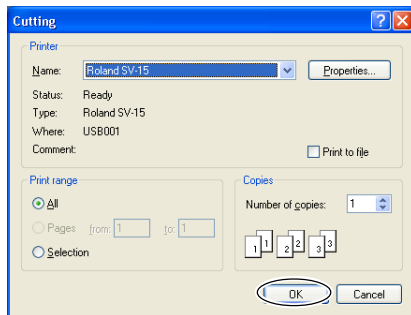

Click [OK].

The cutting data is sent from the computer and cutting starts.

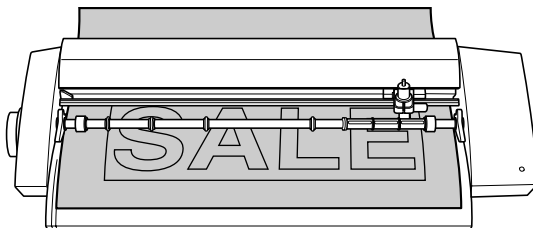

Cutting of the "SALE" text and the box ends.

- ④ Press the power button and turn power off.  
Verify that the power light extinguishes.



Turn the sheet feed knob and remove the material.

### To Stop Cutting While in Progress

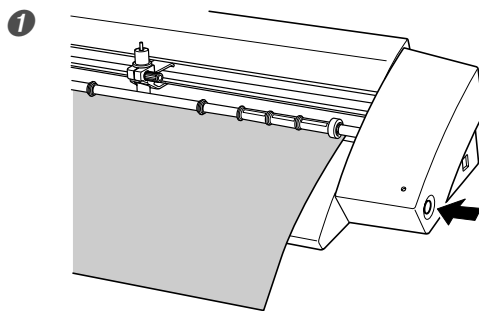

Press the power button and turn the machine off.

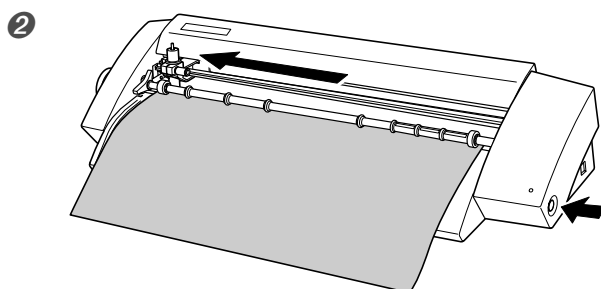

Press the power button again and turn the machine on.  
The cutting carriage returns to the left edge.

If you need to cut the material again, first remove and then reload it.

- You can also cancel a cutting operation from STIKA Navi. For more information, refer to the "Windows Advanced Guide" (electronic format).

## Step 4: Apply the Cut Material

Use application tape to affix the cut material. Cut the application tape to the required size for use. Before applying, thoroughly clean the surface where you want to affix the material to remove any dust or grease.

### Procedure

1

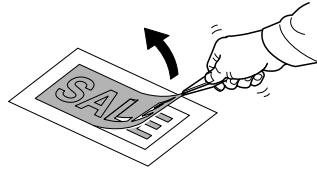

Remove the excess tape so that only text remains.

Use a commercially-available tweezers to remove small pieces of tape better.

2

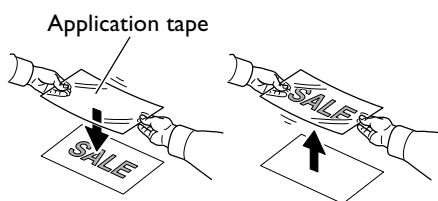

Cut the application tape to the required size. Cover the cut material flush with the application tape to prevent any air from getting underneath, then transfer the material.

You can transfer the material easily by using a commercially available squeegee or the flat part of a ruler or the like to rub the cut material from above the application tape.

3



Affix the material together with the joined application tape to the target object, then press down on it from above.

4



Make sure the material is affixed to the object, then slowly peel off the application tape.

If air becomes trapped between the material and the application surface, forming an air bubble, then use a needle to pop the bubble and press out the air to form a complete seal.

5



This completes the procedure for attaching the material.

### Material After Cutting

Transfer the cut material to the application tape and affix it to the object as soon as possible. Any dust that builds up on the surface of the material can make it difficult for the application tape to stick.

# ***Chapter 4:***

## ***Mastering the STIKA***

---

This describes in details how to adjust the blade extension amount, how to correct the angle of the loaded material, and how to create cutting data.

# 4-I Optimizing the Cutting Quality for the Material

## Check the Cutting Quality for the Material

Perform a cutting test to check the cutting quality for the material. Perform a cutting test when changing the material type and when adjusting the blade extension.

- Make sure to load material before performing a cutting test. Failure to do so could damage the blade and blade protector.
- Do not move the cutting carriage with your hand. Doing so could damage the machine.
- Do not touch any moving parts while the machine is operating. Doing so could cause a malfunction.

### Procedure

1 Load the material.

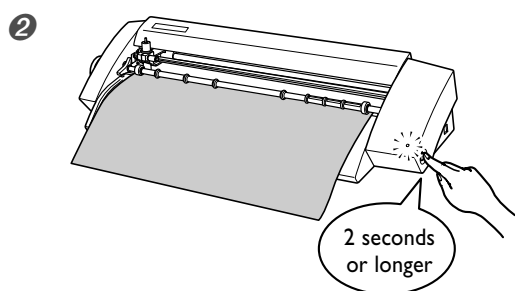

With the power light on, hold down the power button for 2 seconds or longer.

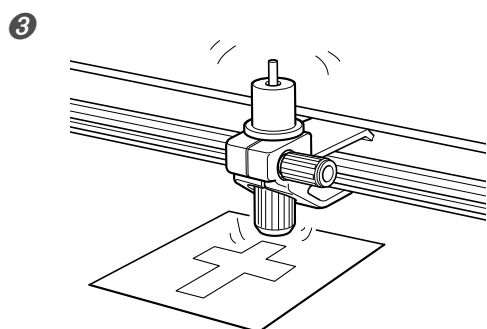

Remove your finger once the cutting carriage starts to move.

Cutting begins from the location that the blade is currently located and the shape indicated in the figure is cut.

To consecutively perform cutting tests, hold down the power button for 2 seconds or longer once the prior cutting operation has finished. This cutting test is done in an area that doesn't overlap with the previous cutting location.

4 Peel off the cut shapes and check the cutting quality for the material.

The material cutting quality is controlled by the blade extension amount. Adjust the blade extension amount depending upon the state of the material when it is peeled off.

☞ p 39 "Adjusting the Blade Extension Amount"

The cross-shaped blade leaves faint traces on the material's backing paper

This is the optimal blade extension amount. No adjustment is required.

The material is difficult to peel from the backing paper

The blade trace is indistinct

Cutting results shift

Extend the blade.

The blade cuts into the backing paper

The blade cuts through the backing paper

The material curls during cutting

Retract the blade.

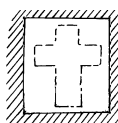

Optimal blade extension amount



The blade extension is too short

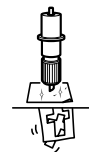

The blade extension is too long



## Adjusting the Blade Extension Amount

**⚠ CAUTION** Do not touch the tip of the blade with your fingers. Doing so may result in injury.

### Procedure

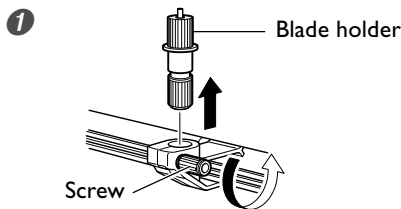

Turn the machine off.  
Loosen the screw, remove the blade holder.

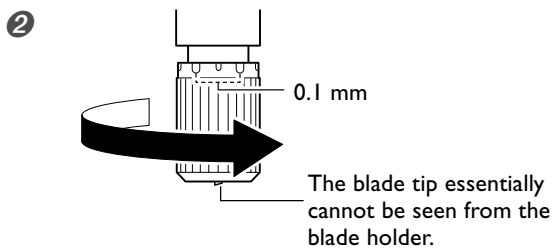

Adjust the blade extension amount.  
Turn the tip of the blade holder as indicated in the figure to extend the blade tip. Turn the large cap once to extend the blade tip by 0.1 mm.

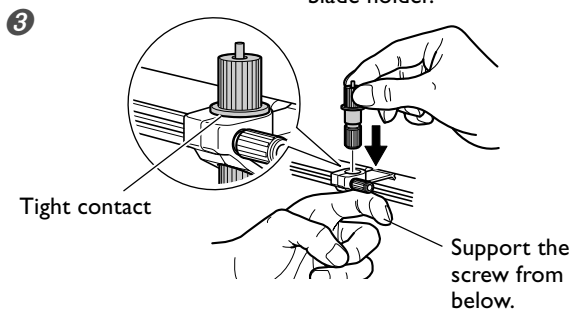

Support the screw from below and insert the blade holder.

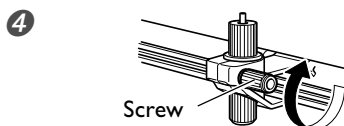

Tighten the screw.  
Tug the blade holder upward to make sure it does not come loose.

5 Carry out the cutting test and check the cutting quality for the material.  
Repeat until optimal cutting quality is attained.  
☞ p 38 "Check the Cutting Quality for the Material"

### Rough Estimate for the Amount of Blade Extension

Use the following dimension as a rough estimate for setting the amount of blade extension.

$$\text{Amount of blade extension} = \text{Thickness of the media portion} + \frac{\text{Thickness of the backing paper}}{2}$$

\* Suggested point  
The optimal setting has been achieved when there are faint lines on the backing paper when a cutting test is executed.

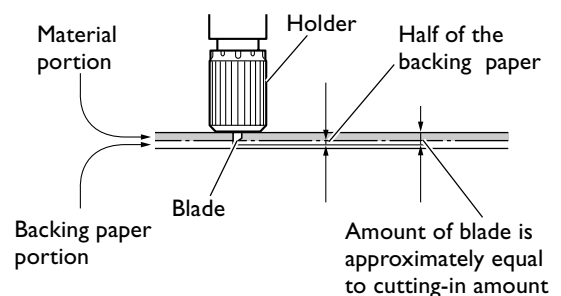

## 4-2 Correcting the Angle of the Loaded Material

If it is not loaded parallel into the machine, the material may come loose during cutting. You can use the sheet adjustment lever to correct the angle of the material without removing it from the machine.

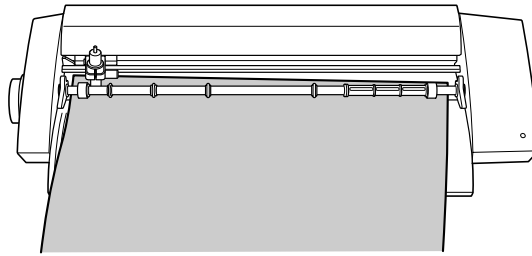

### Procedure

1

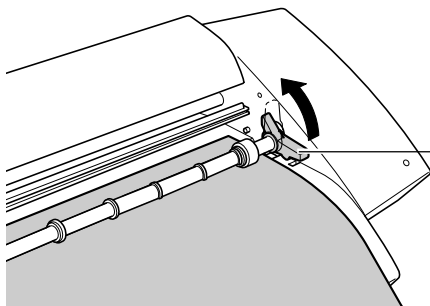

Sheet adjustment lever

Raise the sheet adjustment lever.

2

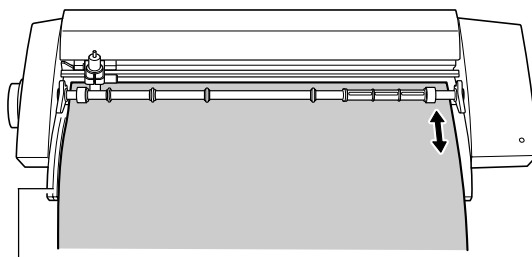

Guide line

Move the material backward and forward and align the left edge of the material with the guide line.

3

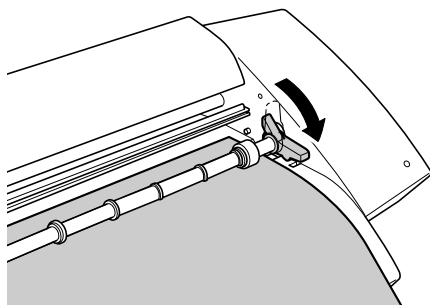

Lower the sheet adjustment lever to fix the material in place.

# 4-3 About Creating Cutting Data

## Creating Various Text Data

The method for changing the size and font of input text using "Properties" is described in this section.

CutStudio can use Windows TrueType-based fonts and OpenType fonts based on TrueType.

### Procedure

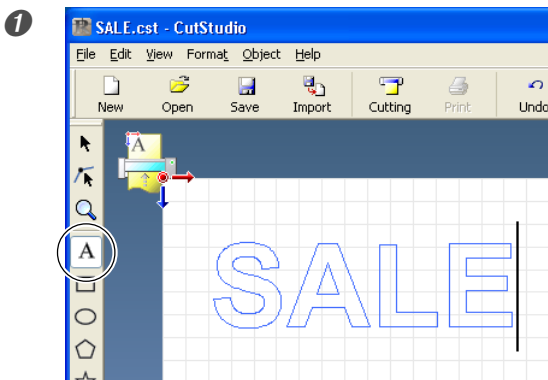

Click [ **A** ].  
Click the desired area and, then type in the characters.

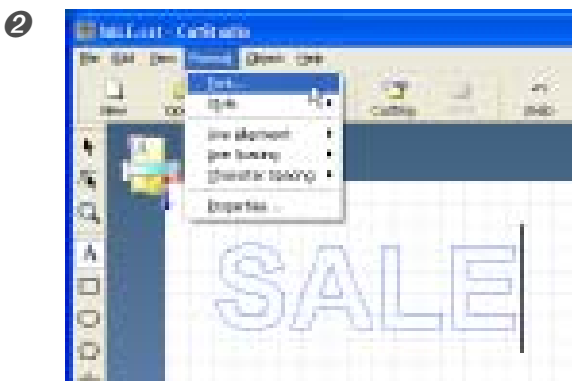

Click [Format] – [Font].  
The [Properties] screen appears.  
You can also display the [Properties] screen as indicated below.

- Click [Format] – [Properties].
- Click [Properties] on the mouse right-click shortcut menu.

3 Change the text size and design.

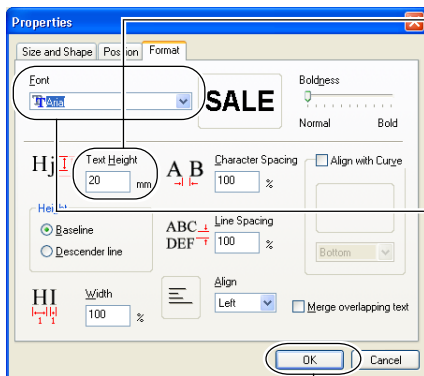

When changing the text size, enter into [Text Height] the height at which you want to cut the text.  
When you change the text height, the text width is changed to the same degree.

To change the text design, click the [v] in the field underneath Font and select the desired font.

Click [OK].  
The font design and size are modified.  
For more information about the [Properties] screen, refer to "Roland CutStudio Online Help."

### 4-3 About Creating Cutting Data

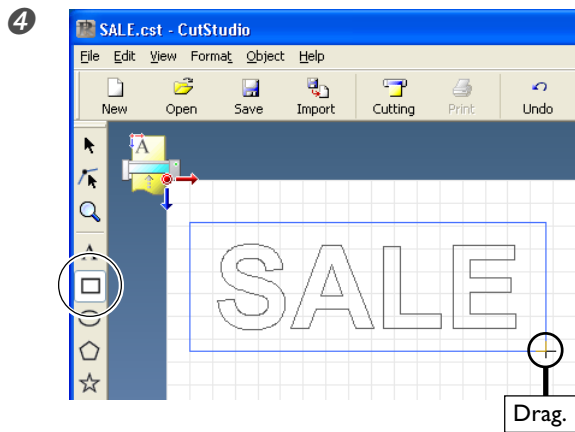

Click [  ].

**Draw a rectangle around the characters.**

Drawing a square around the text will make the material easier to peel off.

When cutting small text, draw a square around each character.

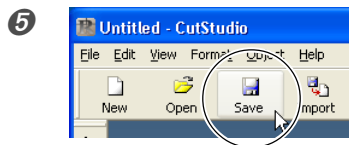

Click [Save].

The [Save As] screen appears.

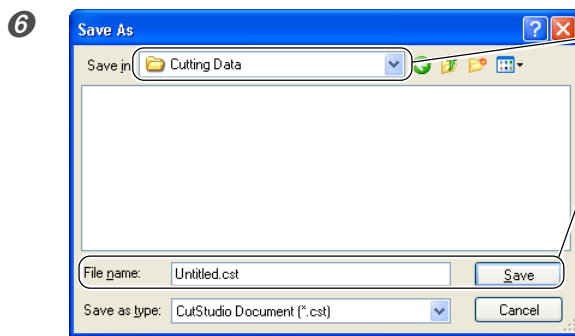

For "Save in," choose the folder you want.

Enter the file name, then click [Save].

The data you created is saved.

## Creating Contour Data by Reading a BMP/JPG Format File

Windows BMP/JPG files can be read by CutStudio, the contours of the image detected, and the resulting image cut. It may be difficult to detect the contours of certain types of read images. Keep the following conditions in mind when selecting images to be read by CutStudio.

### Data Conditions for Clean Cutting

- Colors must not contain continuous tones and color borders must be clearly defined.  
We recommend black and white.  
Scanned photos generally contain continuous tones and are unsuitable for cutting.



- Increasing resolution  
The optimal resolution differs depending upon image complexity and cutting size.  
High-resolution data takes longer for CutStudio to read.

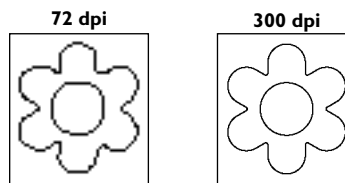

### Procedure

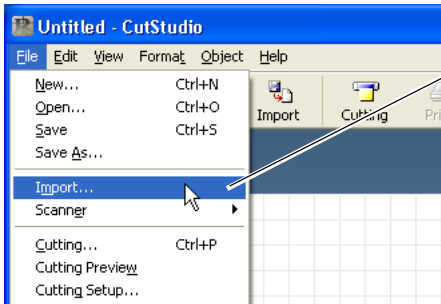
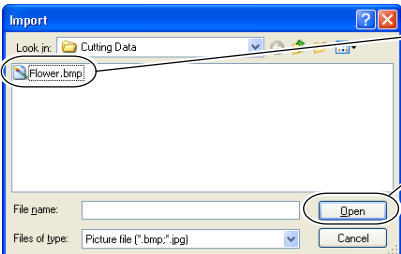
- 1  Click [File], then click [Import].  
The [Import] screen appears.
- 2  Select the desired file.  
Click [Open].  
The read data is laid out.

### 4-3 About Creating Cutting Data

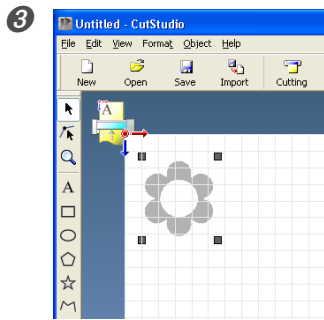

Adjust the size and location.

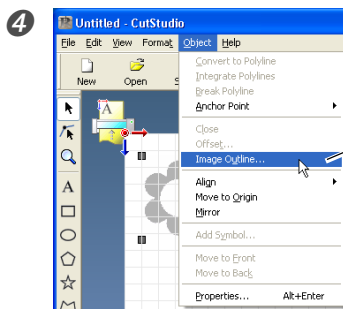

Click [Object] – [Image Outline].  
The [Image Outline] screen appears.

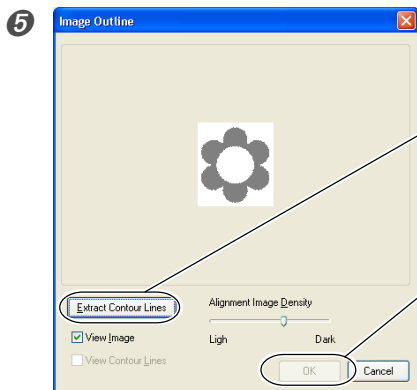

Click [Extract Contour Lines].  
The image contour is detected.  
The contour displays as a blue line.  
Verify that the contour line is correct, and then click [OK].  
The image contour is detected.

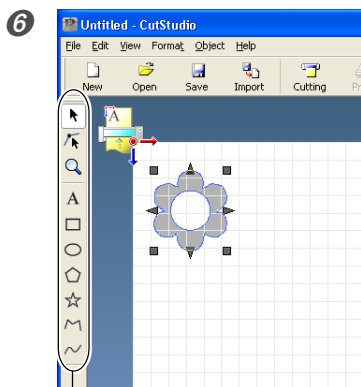

Object tool

You can use the object tool to reshape the image if needed.  
For more information about how to use the object tool, refer to "Roland CutStudio Online Help."

## Deleting Undesired Cutting Lines

CutStudio can be used to delete contour line that is not needed.

### Procedure

1

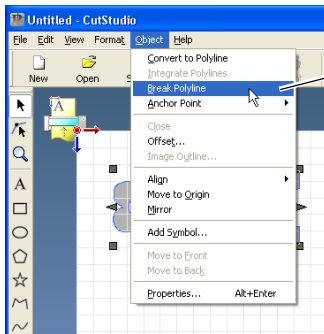

Select the detected contour line.  
Click [Object] – [Break Polyline].  
The image contour is separated.

2

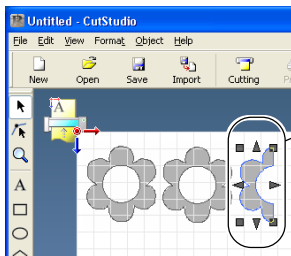

Click on the undesired cutting line.  
Click [Edit] – [Delete].  
The undesired cutting line is deleted.  
The read data remains and is not deleted.

3

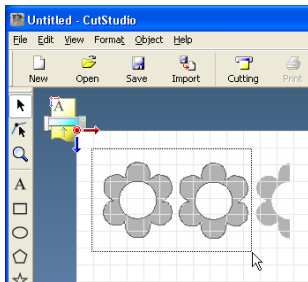

Drag the mouse to select the remaining contour lines.

To select all contour lines on the CutStudio screen, click [Edit] – [Select All].  
Hold down the Shift key and click contour lines to select only those desired.

4

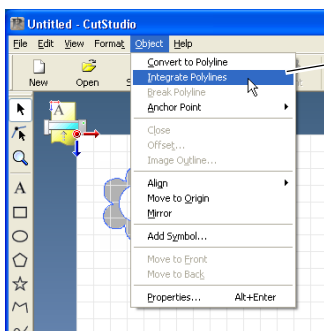

Click [Object] – [Integrate Polylines].  
The separated contour line is made whole.

## 4-4 Applying Large Materials

As the size of the material to be applied increases, it will become increasingly difficult to keep the entire material from slipping during application and to prevent air bubbles from becoming trapped between the material and application surface.

Spray the application surface with detergent-containing water to allow you to move and place the material in the desired location, and to decrease the likelihood of bubbles becoming trapped between the application surface and material.

### Procedure

① Prepare the cut material and tape the material from the top with application tape.

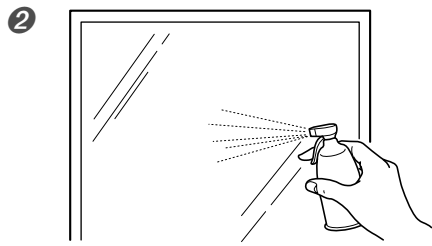

Remove any dust and grease from the application surface.

Use a commercially available spray bottle to liberally spray the application surface with water containing 2 to 3 drops of a neutral detergent.



Apply the material to the application surface.

Adjust the material location and angle.



Use a commercially available squeegee or the flat part of a ruler to remove all remaining moisture.



Once all water has evaporated, slowly peel off the application tape.



# ***Chapter 5:*** ***Maintenance***

---

This describes how to clean the machine and replace the blade.

# 5-I Maintenance

When cleaning, unplug the machine's power cord and remove all material.

## Cleaning the Blade Tip

**⚠ CAUTION** Do not touch the tip of the blade with your fingers.  
Doing so may result in injury.

Dust and material adhesive can collect on the tip of the blade and degrade cutting performance. Remove any dust or material adhesive adhering to the blade tip.

## Cleaning the Blade Holder

**⚠ CAUTION** Do not touch the tip of the blade with your fingers.  
Doing so may result in injury.

Dust and adhesive material can collect within the blade holder and degrade cutting performance. Take off the tip of the blade holder and remove any pieces of material inside.



Turn the tip of the blade holder as indicated in the figure to remove.

## Cleaning the Main Unit

Use a dry cloth to gently wipe any dirt from the main unit. Never use a solvent such as thinner or benzene.

# 5-2 Replacing Consumables

## Replacing the Blade

If you adjust the blade amount and implement a cutting test several times, and the machine still does not properly cut the material, the blade tip may be worn or damaged. Replace with a new blade. Before replacing the blade, remove the material.

**⚠ CAUTION** Do not touch the tip of the blade with your fingers. Doing so may result in injury.

### Procedure

1 Unplug the power cord from the machine.

2

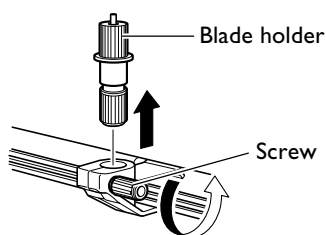

Loosen the screw, remove the blade holder.

3

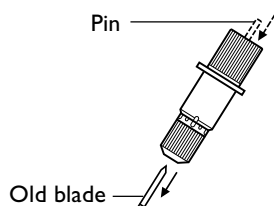

Press the pin and remove the old blade.

4

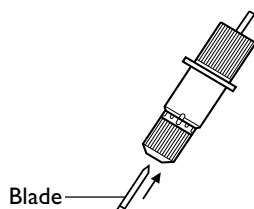

Press the new blade in until you hear an audible click.

5

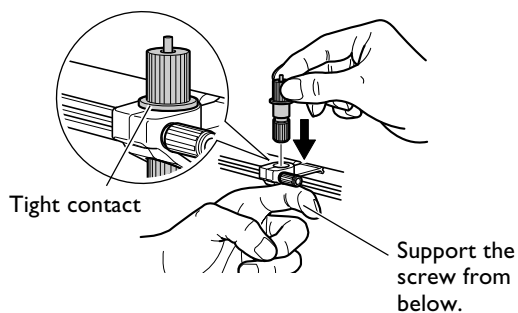

Support the screw from below and insert the blade holder.

6

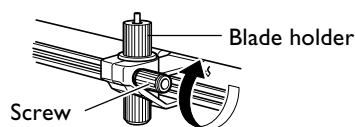

Tighten the screw.

Tug the blade holder upward to make sure it does not come loose.

## Replacing the Blade Protector

Even if the blade protector is slightly damaged, cutting operation will not be affected. If the blade protector is damaged to the extent that cutting quality is degraded, replace it with the included replacement blade protector.

**⚠ CAUTION** The cutter knife used here is sharp and poses a hazard. Carry out operations with caution to avoid injury.

### Procedure

① Unplug the power cord from the machine.

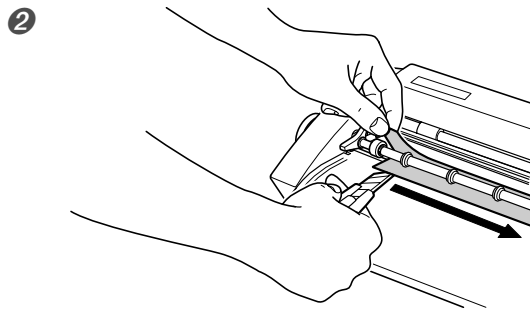

**Peel the blade protector from the main unit.**

Use a commercially available retractable knife to facilitate removal.

If you are using the SV-15, raise the left/right sheet adjustment levers and remove the blade protector.

\* Do not place your hands in front of the direction that you are moving the retractable knife.

③ Wipe and remove any glue remaining on the main unit.  
Use a cloth to wipe clean.

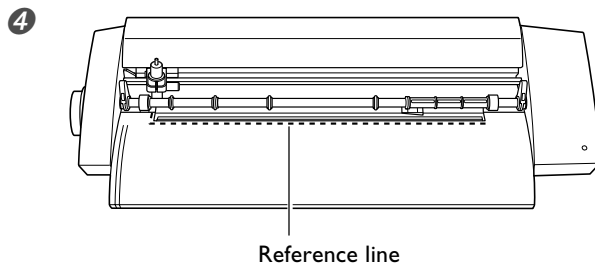

**Place the replacement blade protector into the machine.**

Align the blade protector using the reference line displayed on the machine.

5

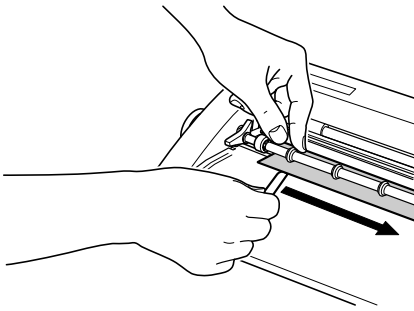

Peel off the double-sided tape and affix the blade protector.

6

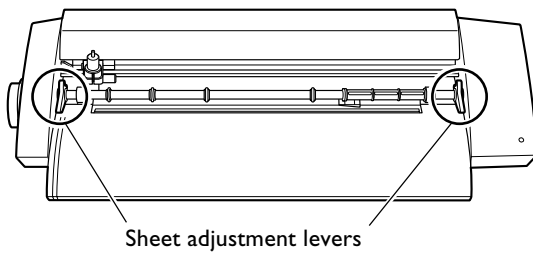

For the SV-15, lower the left/right sheet adjustment levers.



# ***Chapter 6:***

# ***Appendix***

---

# 6-1 What to Do If

This section describes what to do if you encounter a problem while using the machine. Refer to this first, before assuming that a malfunction has occurred. The method for resolving problems not listed below are indicated in the "Windows Advanced Guide" or "Macintosh Cutting Guide" (electronic format). Use both as necessary.

## The machine does not run properly

### Is the cable properly connected?

If the power cord or USB cable are not properly connected, refer to the following page and connect properly.

☞ p 16 "Connecting the Cables"

### Are the settings for the driver correct?

Make sure the communication port is set correctly.

### Is the power lamp flashing?

The problem is a communication or command error. Turn power off, verify the cable connection and computer/software settings.

### Power does not turn off even when the power button is pressed

Unplug the AC adapter from the machine.

## The cut incisions are not clean

### Is the blade extension amount optimal?

Check whether the blade extension amount has been adjusted.

☞ p 39 "Adjusting the Blade Extension Amount"

### Is the blade holder fixed in place?

Firmly attach so that the screw does not loosen during cutting.

### Is the tip of the blade broken?

Replace with a new blade.

☞ p 49 "Replacing the Blade"

## Parts of the material are not continuously cut

### Is the tip of the blade broken?

Replace with a new blade.

☞ p 49 "Replacing the Blade"

### Is dust or material adhesive attached to the blade tip?

Remove the blade and clean the tip.

☞ p 48 "Cleaning the Blade Tip"

### Is there a build-up of material adhesive or dust within the blade holder?

Take off the tip of the blade holder and remove any pieces of material inside.

☞ p 48 "Cleaning the Blade Holder"

### Are there any scratches on the blade protector?

If the blade protector is damaged, correct cutting of material may be impossible even if the machine's settings and the installation of the blade and blade holder are all correct. Replace with a new blade protector.

☞ p 50 "Replacing the Blade Protector"

### Is the blade holder damaged or worn?

Replace with a new blade holder.

## The cut location is shifted forward/back

### Is the blade extension amount optimal?

Check whether the blade extension amount has been adjusted.

☞ p 39 "Adjusting the Blade Extension Amount"

### Did the material come up against an obstruction while it was being cut?

Do not place anything in front of or behind the machine. This can obstruct the material feed and cause the cut location to shift.

## The cut location is shifted left/right

If the cut location shifts as indicated below, check the following.

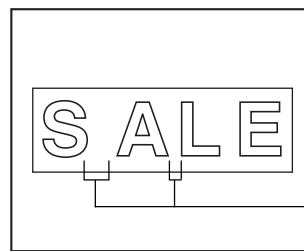

The spacing between characters differs

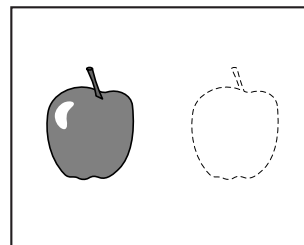

A location different than the data indicates is cut



**Is the blade extension amount optimal?**

Check whether the blade extension amount has been adjusted.

☞ p 39 "Adjusting the Blade Extension Amount"

**Does the cutting carriage move abnormally and do you hear a strange noise?**

Remove any dust or material adhesive adhering to cutting carriage guide shaft and then lubricate.

☞ p 57 "Shaft Lubrication"

**The material shifts during cutting****Is the material length 500 mm (19-5/8 in.) or longer?**

If they are 500 mm (19-5/8 in.) or longer, certain types of material may shift during cutting. Either switch to a different kind of material, or shorten the material length.

**Is the material length too short?**

If too short, certain types of material with little rigidity may shift during cutting. Either switch with a different material or use a longer length of the same material.

**Are the material edges evenly cut?**

If the material edges are cut at an angle, trim the excess so that the material is even with the guidelines when loaded.

**Did the material come up against an obstruction while it was being cut?**

Do not use material wider than can be handled. The left and right edges of the material will touch the inner surfaces of the machine and in addition to shifting the location, the material may also be damaged.

**Are you using material that has creases or folds?**

This may prevent the material from properly feeding and may shift the material position. Remove the creases or folds and reload the material.

**If the driver cannot be installed**

If installation quits partway through, or if the wizard does not appear when you make the connection with a USB cable, take action as follows.

**Windows XP/2000**

- 1 If the [Found New Hardware Wizard] appears, click [Finish] to close it.

- 2 Display [System Properties].

Windows XP

Click the [Start] menu, then right-click [My Computer]. Click [Properties].

Windows 2000

Right-click [My Computer] on the desktop. Click [Properties].

- 3 Click the [Hardware] tab, then click [Device Manager].

The [Device Manager] appears.

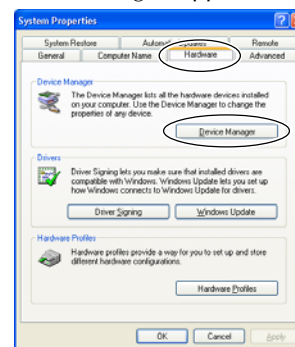

- 4 Delete the model name in use (or [Unknown Device]).

- 1 At the [View] menu, click [Show hidden devices].
- 2 Find [Printers] or [Other device], then double-click it.
- 3 Click the model name in use (or [Unknown Device]).
- 4 Go to the [Action] menu, and click [Uninstall].
- 5 After the screen shown above appears, click [OK].

- 5 Close the [Device Manager] and click [OK].
- 6 Detach the USB cable connected to the computer.
- 7 Restart Windows, and refer to "Uninstalling the driver" below to uninstall the driver.
- 8 Redo the installation from the beginning.
  - ☞ p 20 "Installing the Driver"

**Windows 98 SE/Me**

- 1 Refer to "Uninstalling the driver" below to uninstall the driver.
- 2 Redo the installation from the beginning.
  - ☞ p 20 "Installing the Driver"

**Uninstalling the driver**

When uninstalling the driver, perform following operation.

- 1 Before you start uninstallation of the driver, unplug the USB cables from your computer.
- 2 Log on to Windows. If you are installing under Windows 2000/XP, log on as "Administrators" right.
- 3 Insert the included CD-ROM into the CD-ROM drive.
  - Go to the upper right and click the [X] to close the setup menu.
- 4 From the [Start] menu, click [Run].

- 5 Type in the information shown below, then click [OK].

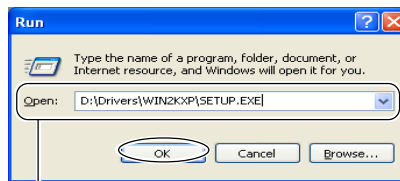

\* In this illustration, drive D is specified as the CD-ROM drive.

**Windows 2000/XP**

(CD-ROM drive letter) :\Drivers\WIN2KXP\SETUP.EXE

**Windows 98 SE/Me**

(CD-ROM drive letter):\Drivers\WIN9X\Setup.exe

The Setup program starts and the [Driver Setup] window appears.

6

- 7 Click [Yes] to restart the computer.

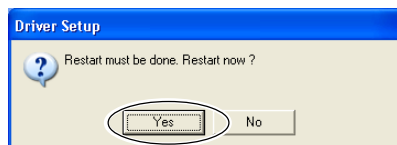

## 6-2 Shaft Lubrication

The material may not cut properly if dust and material adhesive adhere to the cutting carriage guide shaft. If the following symptoms are present, remove the shaft cover and lubricate the shaft located as indicated in the figure. Use a machine oil to lubricate.

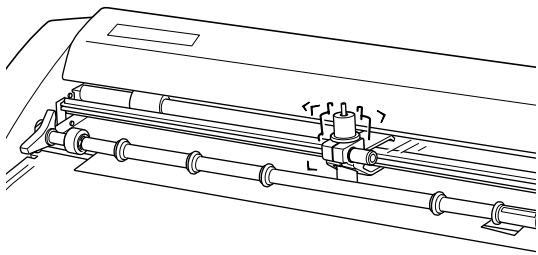

It does not move smoothly

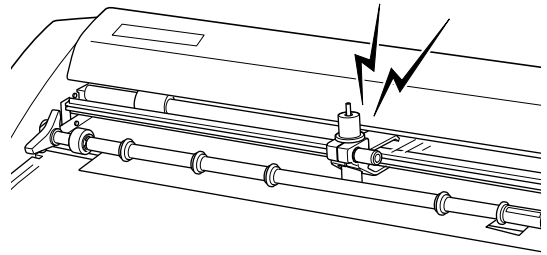

You hear an abnormal noise

### Procedure

- 1 Unplug the power cord from the machine.

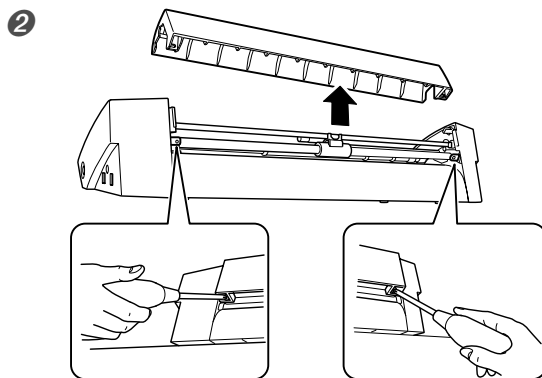

Remove the shaft cover.

Use a Phillips head screwdriver to remove the screws.

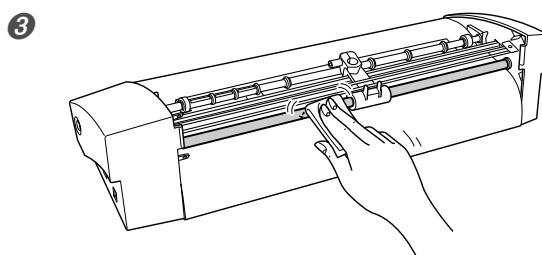

Wipe and remove dust adhering to the shaft.

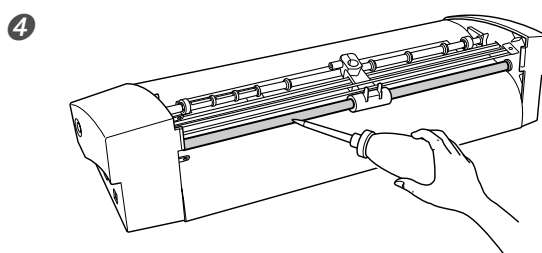

Use machine oil to lightly lubricate the shaft section indicated in the figure to the left.

Using too much oil can cause the material to stain.

- 5 Replace the shaft cover and screw into place.

# 6-3 Cutting Range

	Cutting Range (width)	Cutting Range (length)	Loadable Material Width	Loadable Material Length
SV-15	340 mm (13-3/8 in.)	1000 mm (39-5/16 in.)	360 to 381 mm (14-1/8 to 15 in.)	1100 mm (43-1/4 in.)
	250 mm (9-13/16 in.)	1000 mm (39-5/16 in.)	280 to 305 mm (11 to 12 in.)	1100 mm (43-1/4 in.)
SV-12	250 mm (9-13/16 in.)	1000 mm (39-5/16 in.)	280 to 305 mm (11 to 12 in.)	1100 mm (43-1/4 in.)
SV-8	160 mm (6-1/4 in.)	1000 mm (39-5/16 in.)	200 to 215 mm (7-13/16 to 8-7/16 in.)	1100 mm (43-1/4 in.)

· The required margin to send the material forward/back is taken.

When using the SV-15

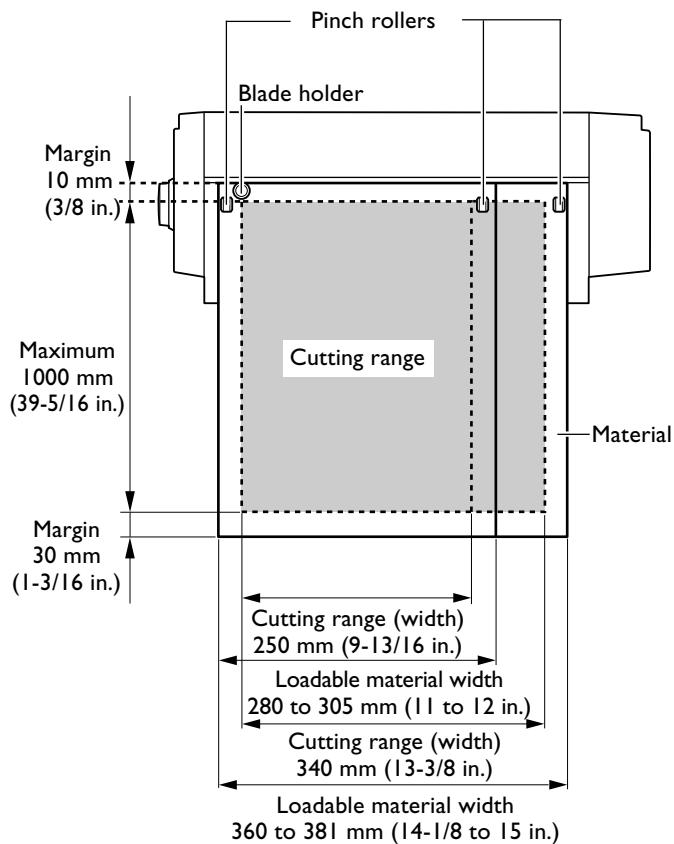

When using the SV-12/8

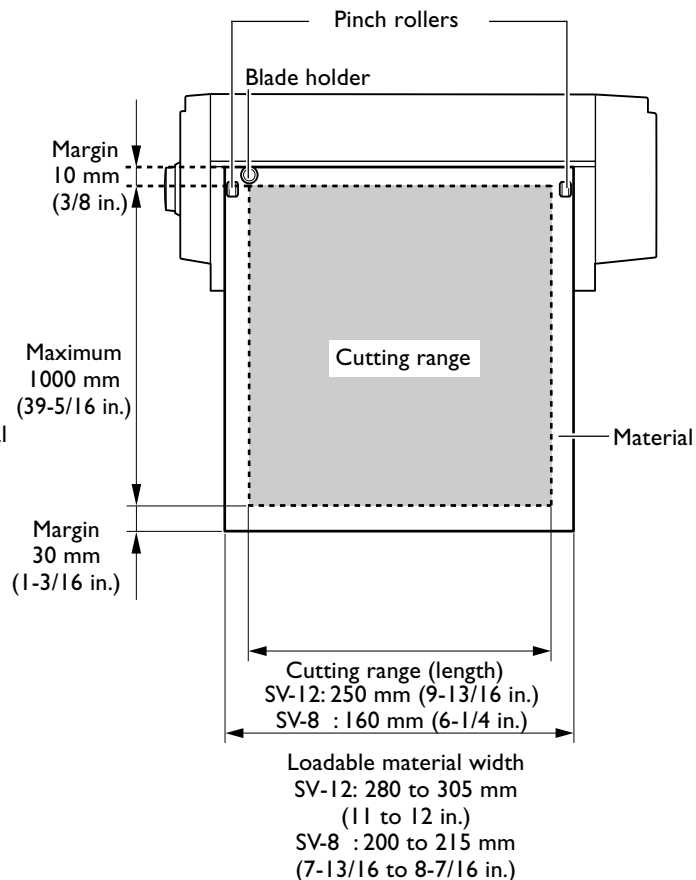

## 6-4 Locations of the Power Rating and Serial Number Labels

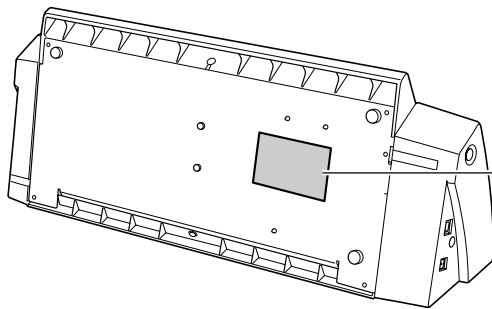

### **Serial number**

This is required when you seek maintenance, servicing, or support. Never peel off the label or let it get dirty.

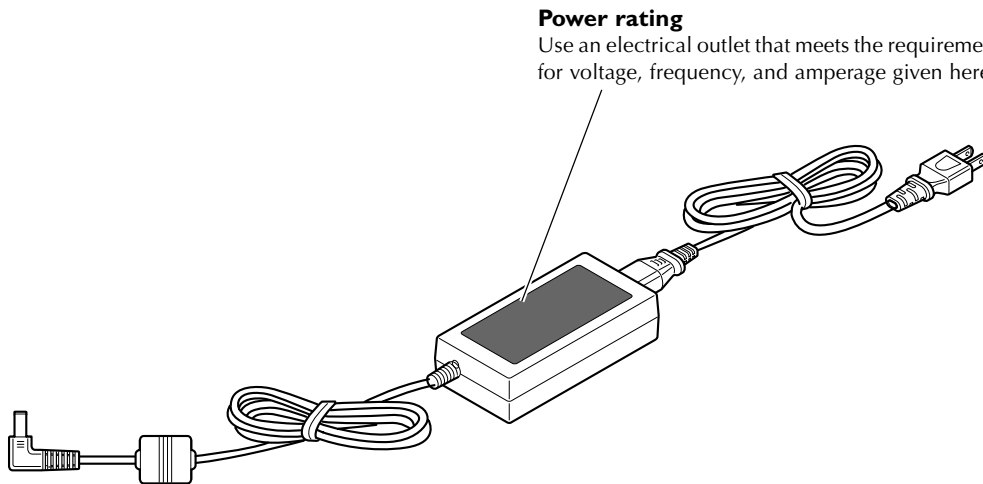

### **Power rating**

Use an electrical outlet that meets the requirements for voltage, frequency, and amperage given here.

## 6-5 Specifications

	SV-15	SV-12	SV-8
Cutting method	Media-moving method		
Maximum cutting range	Width: 340 mm (13-3/8 in.) Length: 1000 mm (39-5/16 in.)	Width: 250 mm (9-13/16 in.) Length: 1000 mm (39-5/16 in.)	Width: 160 mm (6-1/4 in.) Length: 1000 mm (39-5/16 in.)
Useable material size <sup>(*1)</sup>	Width: 360 to 381 mm (14-1/8 to 15 in.) Length: 1100 mm (43-1/4 in.) or less  Width: 280 to 305 mm (11 to 12 in.) (A3 length, A4 width) Length: 1100 mm (43-1/4 in.) or less	Width: 280 to 305 mm (11 to 12 in.) (A3 length, A4 width) Length: 1100 mm (43-1/4 in.) or less	Width: 200 to 215 mm (7-13/16 to 8-7/16 in.) (A4 length) Length: 1100 mm (43-1/4 in.) or less
Maximum cutting speed	12 to 100 mm/sec. (7/16 to 3-7/8 in./sec.)	12 to 40 mm/sec. (7/16 to 1-9/16 in./sec.)	12 to 40 mm/sec. (7/16 to 1-9/16 in./sec.)
Useable material type <sup>(*2)</sup>	Vinyl chloride material (material section thickness alone is 0.1 mm or less, thickness including backing paper is 0.3 mm (0.012 in.) or less) Label paper (Thickness including backing paper is 0.3 mm (0.012 in.) or less)		
Interface	USB 1.1		
Power supply	Dedicated AC adapter Input: AC 100 to 240 V ± 10%, 50/60 Hz Output: DC 19 V, 2.1 A		
Power consumption	Approx. 20 W (including AC adapter)		
Dimensions	522 (W) × 205 (D) × 115 mm (H) (20-5/8 (W) × 8-1/8 (D) × 4-1/2 in. (H))	440 (W) × 205 (D) × 115 mm (H) (17-3/8 (W) × 8-1/8 (D) × 4-1/2 in. (H))	340 (W) × 205 (D) × 115 mm (H) (13-3/8 (W) × 8-1/8 (D) × 4-1/2 in. (H))
Weight	3.3 Kg (7.3 lb)	2.7 Kg (6 lb)	2.2 Kg (4.9 lb)
Acoustic noise level	60 dB (A) or less (according to ISO7779)		
Operating environment	Temperature: 5 to 40°C (41 to 104°F), humidity: 35 to 80% (no condensation)		
Included items	AC adapter, power cord, USB cable, replaceable blade protector, blade, blade holder, pin, test-use material, test-use application tape, CD-ROM, user's manual		

\*1  
Depending upon the type, material that is 500 mm (19-5/8 in.) or longer may shift during cutting.

\*2  
You may also be unable to cut some types of material.



## Please read this Agreement before unpacking the media.

### Software license agreement

Roland DG Corporation (hereinafter referred to as the "Company") shall grant you a non-transferable, non-exclusive right to use the Software supplied with this Agreement, on the condition that you agree to the following provisions.

If you agree to the following provisions, you should unpack the media on which the Software is recorded, or simply click the button or other indicator that you agree to the following provisions. By doing so, this Agreement shall be concluded.

If you do not agree with the following provisions, do not unpack the media. Or, you can click the button or other indicator that you do not agree to the following provisions of this Agreement. In this case, a license is not granted and you cannot use the Software.

#### 1. Definition

The "Software" includes the software program and related files supplied with this Agreement and the related software programs and files distributed through the Internet and other services.

#### 2. Ownership

All the ownership, copyright and other intellectual property rights of the Software, trademark, and related documents shall belong to the Company.

#### 3. Terms and conditions

- (1) You are authorized to use the Software on one computer.
- (2) You are allowed to create a backup copy of the Software.

The right to keep the Software and the backup copy of the Software continues to belong to the Company, but the right to the media on which the backup copy of the Software is recorded does not belong to the Company.

#### 4. Forbidden items

- (1) This copy of the Software, or a backup copy of the Software, must not be used on multiple computers at the same time, on a network, the Internet, or on other computers through any other means of distribution.
- (2) The Software shall not be reverse engineered, decompiled or reverse assembled.
- (3) The rights to the Software cannot be transferred, assigned, lent, loaned or licensed to a third party in any case, regardless of whether this Agreement has been terminated or cancelled.

#### 5. Termination

- (1) The Company can cancel this Agreement and require you to discontinue use of the Software if you breach any provision of this Agreement or if you infringe on the ownership, copyright, or other intellectual property rights of the Company.
- (2) This Agreement shall be automatically terminated when you stop using the Software.
- (3) If this Agreement is terminated or cancelled, you must return your copy of the Software to the Company, or discard it as soon as practicable, at your own expense.

#### 6. Guarantee

- (1) The Company shall not guarantee that the quality or functionality of the Software will satisfy any purpose that you may have in mind.
- (2) The Company shall not accept any responsibility for the results obtained from using the Software.
- (3) The Company shall not accept any responsibility for any loss which might be caused as a result of your exercising the rights granted under this Agreement.
- (4) The specifications for the Software are subject to change without prior notice.

#### 7. Governing Law

This agreement is governed by the laws of Japan, and the parties shall submit to the exclusive jurisdiction of the courts of Japan.



1000005840

R4-081203