

## PROGRAMMER'S MANUAL **NC code**

---

Thank you very much for purchasing the MDX-650/500.

- To ensure correct and safe usage with a full understanding of this product's performance, please be sure to read through this manual completely and store it in a safe location.
- Unauthorized copying or transferral, in whole or in part, of this manual is prohibited.
- The contents of this operation manual and the specifications of this product are subject to change without notice.
- The operation manual and the product have been prepared and tested as much as possible. If you find any misprint or error, please inform us.
- Roland DG Corp. assumes no responsibility for any direct or indirect loss or damage which may occur through use of this product, regardless of any failure to perform on the part of this product.
- Roland DG Corp. assumes no responsibility for any direct or indirect loss or damage which may occur with respect to any article made using this product.



# Table of Contents

Introduction .....	2
--------------------	---

## Part 1 Programming Basics

Programming .....	3
Coordinate Systems .....	7
Setting Coordinate Values (Amount of Movement) .....	10
Setting the Measurement Unit .....	11
Real-number Entry and Integer Entry .....	11
Program Number .....	12
Sequence Numbers .....	12
Optional Block Skip .....	12
Positioning (G00) .....	13
Linear Interpolation (G01) .....	13
Circular Interpolation (G02 and G03) .....	13
Cutter Compensation (G40, G41 and G42) .....	15
Feed Rate .....	15
Spindle Motor Control (M03 and M05) .....	16
Spindle Motor Speed .....	16
Fixed Cycle .....	16
Program-related Errors .....	16
Sample Program .....	18

## Part 2 Reference

[ Preparatory Functions (G Functions) ] .....	20
G00           Positioning .....	20
G01           Linear Interpolation .....	21
G02 and G03   Circular Interpolation .....	22
G04           Dwell .....	25
G10           Data Setting .....	26
G17, G18 and G19   Plane .....	28
G20 and G21   Setting the Measurement Unit .....	28
G39           Corner-offset Circular Interpolation .....	29

G40, G41 and G42   Cutter Compensation .....	30
G50 and G51       Scaling .....	38
G54, G55, G56, G57, G58 and G59   Selects Coordinate System .....	39
G80, G81, G82, G83, G85, G86 and G89   Fixed Cycle (Canned Cycle) .....	40
G90 and G91       Absolute and Incremental .....	44
G92               Coordinate System .....	45
G98               Initial Level Return .....	46
G99               Point R Level Return .....	46
[ Miscellaneous Functions (M Functions) ] .....	47
M00           Program Stop .....	47
M01           Optional Stop .....	47
M02           End of Program .....	47
M03 and M05   Spindle Motor Start/Stop .....	47
M30           End of Program .....	48
M98           Subprogram Call .....	48
M99           End of Subprogram .....	50
[ Spindle Speed Function (S Function) ] .....	51
[ Feed Functions (F Functions) ] .....	53
[ Other Functions ] .....	54
N             Sequence Number .....	54
O             Program Number .....	54
/             Optional Block Skip .....	55
% or ER       Program Start .....	55
EOB           End of Block .....	56
( )           Comment .....	56

## Appendices

Words Table .....	57
Character Code Table (ISO, EIA, and ASCII) .....	59

---

# Introduction

## What Is in This Manual

This manual explains those codes interpreted by numerical control machine tools (NC codes) which are supported by MDX-650/500. Codes and functions which are not supported are not described.

## This Manual Has Two Parts

**“Part 1 — Programming Basics”** describes such basic but necessary programming-related matters as programming, coordinate systems, and how to set coordinate values (amount of movement).

**“Part 2 — Reference”** explains each of the codes in an encyclopedic form. Once a certain familiarity with programming has been achieved, programming can be accomplished simply by glancing through this part.

# Part 1 Programming Basics

## Programming

### The Process of Programming

First, examine the drawing and determine such conditions as the workpiece material, the size of the workpiece to be prepared, the tool diameter, the tool type, the proper turning speed, and the proper feed rate. Then determine the sequence in which to cut. The cutting sequence is in extremely important point for carrying out cutting efficiently and safely.

In actual cutting, the moving portion may be either the workpiece or the spindle. Programming is carried out with consideration given to how the tool moves, with no distinction made for the actual movement.

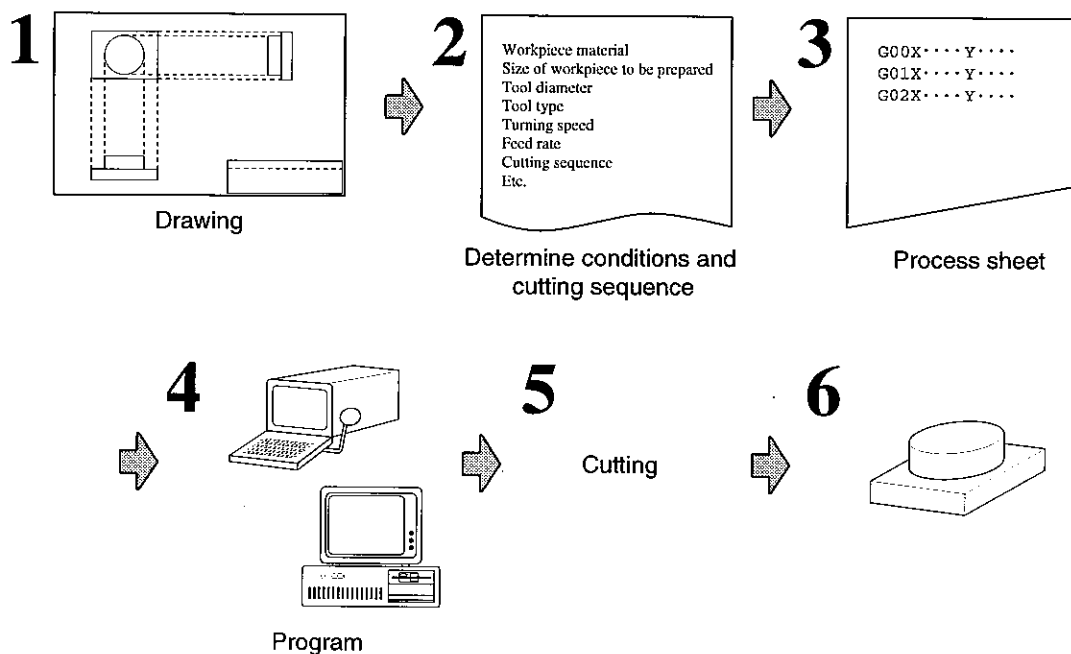

Once the appropriate conditions and cutting sequence for the job have been determined, then before cutting is begun, the programming steps are written down on a piece of paper like the one shown below. (This form is called a "process sheet.") This sheet is handy for confirming the cutting sequence and numerical values.

N	G	X	Y	Z	A	S	F	M	%
N 01									%
N 02	G 90								
N 03	G 00			Z ....					
N 04		X ....	Y ....						
N 05						S 5000	F 300	M 03	
N 06	G 01			Z ....					
N 07					A ....				
N 08		X ....							
N 09			Y ....						
N 10	G 02	X ....	Y ....						
N 11		X ....	Y ....				F 150		

## Program Structure

A program can be classified as a "main program" or a "subprogram."

### Main Program

Ordinarily, the machine operates according to instructions from a main program.

### Subprogram

If a main program can be likened to the trunk of a tree, then subprograms are branches. When a main program specifies execution of a subprogram of a certain number, the subprogram of that number is called up and executed.

Subprograms can be convenient when writing a program where the same task is to be performed a number of times. Program modularity can also be promoted by creating subprograms which have good general utility.

A subprogram can call another subprogram.

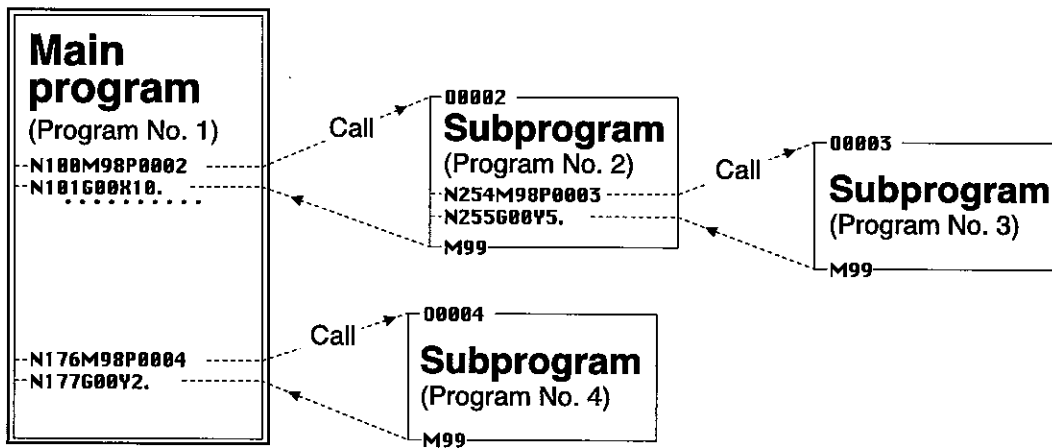

Conceptual view of a main program and subprograms

## Program Structure and Format

Programming proceeds in accordance with the process sheet that has been prepared. The program is input using a dedicated input device for NC codes, or with a general-purpose computer.

Input is made as shown in the figure below. Addresses such as G, M, X, I, and J are combined with numbers to specify the cutting steps and tool movements.

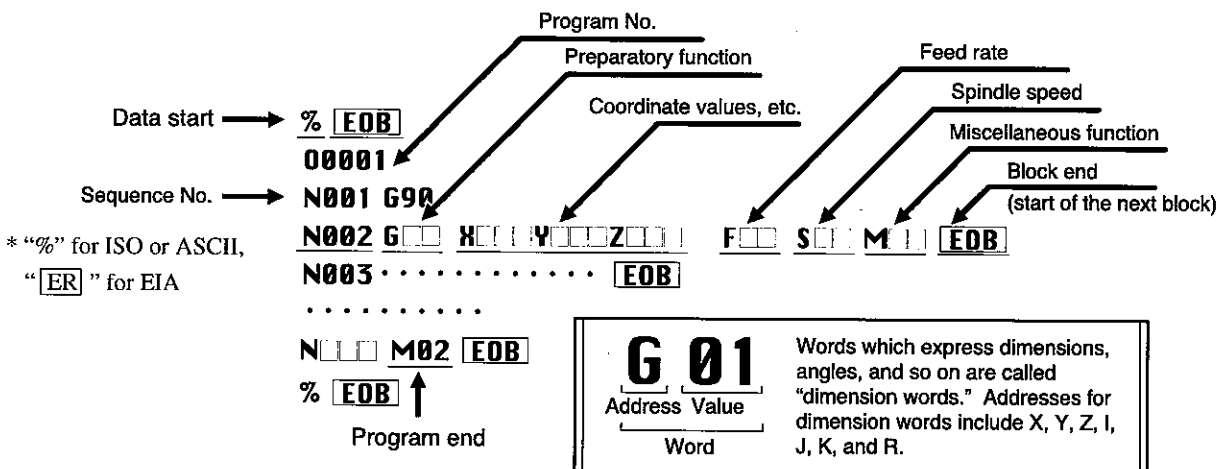

(\* For details on blocks, see "About Blocks," which is the following section.)

- %** : A block containing only a “%” must appear at the start of the data. This notifies the machine of the start of the data. Such a block may optionally be present at the end of the data.  
The character indicating the program start is “%” in the case of ISO or ASCII code, or “**ER**” in the case of EIA.
- EOB** : The **EOB** (end of block) indicates the conclusion of the block. In ASCII, this is the **LF** (line feed) code.
- O** : This inputs the program number. A program starts with a program number, and ends with either M02, M30, or M99. M02 or M30 signifies the end of a main program, and M99 signals the end of a subprogram. Program numbers are numerical values (integers). When four-digit numbers have been specified, you can enter program numbers from 0001 to 9999. When eight-digit numbers have been specified, you can enter numbers from 00000001 to 99999999. Be careful to ensure that there are no duplicate program numbers or program numbers with different numbers of digits within a single program.  
Program numbers are used to call up subprograms.
- N** : Sequence numbers are reference numbers for the program. They have absolutely no effect on the program (machine operation).
- G** : This is the preparatory function. The special functions are specified by the two-digit code following the “G.”
- X(I)** : This indicates a coordinate value or movement distance. I, J, and K are used to specify the center coordinate of a circle (or arc).
- Y(J)** : This indicates a coordinate value or movement distance. I, J, and K are used to specify the center coordinate of a circle (or arc).
- Z(K)** : For positive coordinates or movement directions, it is not necessary to prefix a “+” to the value.
- R** : This indicates an angle or movement distance.
- F** : This determines the feed rate.
- S** : This determines the speed of the spindle motor.
- M** : This is a miscellaneous function. It is used for such operations as starting and stopping the spindle motor.
- M02** : This signals the end of the program. The spindle stops.

## About Blocks

A program is a series of instructions (written commands) for the machine, expressed as symbols and numbers. The instructions are separated by **EOB** markers, with the information between two **EOB** markers making up one instruction. This single instruction between two **EOB** markers is called a “block.” Each block, in turn, is composed of “words.”

The types of words include those valid only within a block, those also valid outside of blocks until a word of the same group is specified, those which activate a function immediately after being specified, those which activate a function at the end of the block in which they are specified, and those which activate a function at the start of the block in which they are specified. Programming requires knowledge of the characteristics of each word. See "APPENDICES-Words Table" or a chart of word characteristics.

<Examples of “words also valid outside of blocks until a word of the same group is specified”>

**%**

- N01 G90** ← Indicates that the specified coordinate value is absolute (G90)
- N02 G01 X100 Y100** ← Linear interpolation from the current tool position to X = 100, Y = 100 (G01)
- N03 Z-20** ← Linear interpolation from the tool position moved to by N02 to Z = -20
- N04 G00 Z20** ← Movement (positioning) from the tool position moved to by N03 to Z = 20 (G00)
- N05 X0 Y0** ← Movement (positioning) from the tool position moved to by N03 to X = 0, Y = 0.

## Data Output from the Computer

Before outputting data, make the appropriate cable connections to link the computer and the machine. Refer to the user's manuals for each model for explanations on making connections and connection specifications.

The character code systems supported by the machine are ASCII, ISO, and EIA. ASCII is an abbreviation for the "American Standard Code for Information Interchange." ASCII is the most widely used code standard established for computers to handle text, and is used by virtually all computers. Text is output as normal ASCII unless you use software which can output ISO or EIA codes to the machine, or a program which converts ASCII to ISO or EIA.

Numerically controlled machine tools (NC machines) generally use ISO (International Organization for Standardization) or EIA (Electronic Industry Association) as their character code system. Both of these use a data length of 8 bits, which means that ASCII, with a length of 7 bits, cannot be used without modification. In an ISO code, the 8th bit is for parity checking, with bits 1 through 7 the same as the corresponding ASCII code. (Refer to "Appendices Character Code Table (ISO, EIA, and ASCII)" .)



## Coordinate Systems

The machine uses the Cartesian coordinate system, which has three axes — the X axis, the Y axis, and the Z axis — each of which is perpendicular to the other two.

When the optionally available rotary axis unit is installed on the MDX-650, a rotation-axis coordinate system made up of an X axis, Z axis, and A axis is added.

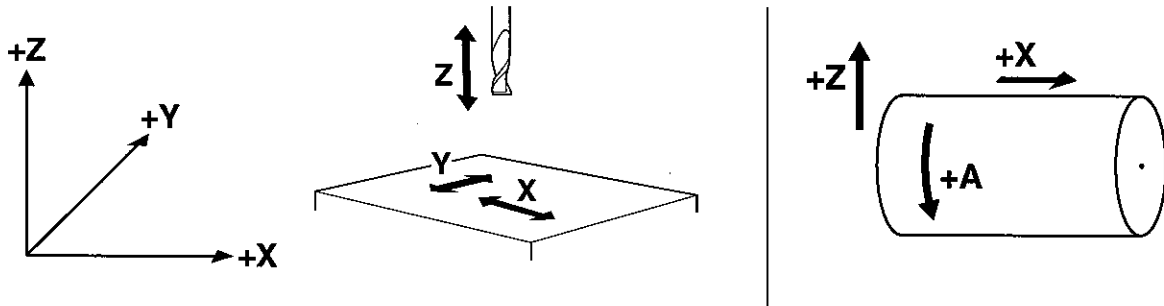

### Machine Coordinate Systems

A machine coordinate system is a coordinate system determined mechanically with reference to the MDX-650/500. The origin point in a machine coordinate system is a point specific to the MDX-650/500, and cannot be moved. The origin point in a machine coordinate system is at the forward-left corner of the machine's maximum range of operation, and is the point to which the machine moves at powerup.

Coordinate values (or amounts of movement) specified in an actual program are coordinates in a workpiece coordinate system.

### Workpiece Coordinate Systems

A workpiece coordinate system is a coordinate system for workpiece machining. The origin point of a workpiece coordinate system is the program's origin point according to an absolute specification.

There are two methods that can be used to set a workpiece coordinate system.

1. Setting using G92
2. Setting using G54 to G59

#### 1. Setting a workpiece coordinate system using G92

A workpiece coordinate is defined by specifying the workpiece coordinate location of the current tool location.

For example, to set a point which is 20 mm (X), 15 mm (Y), 10 mm (Z) from the point to be taken as the origin of the present tool location, the following should be set:

**G92X20.0Y15.0Z10.0**

Normally, the tool is moved to a point on the loaded workpiece and G92X0Y0Z0 (the workpiece coordinate origin point) is set.

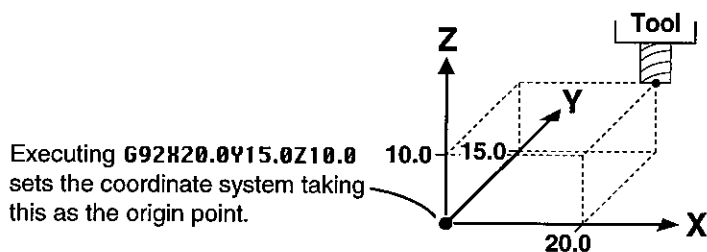

Executing **G92X20.0Y15.0Z10.0** sets the coordinate system taking this as the origin point.

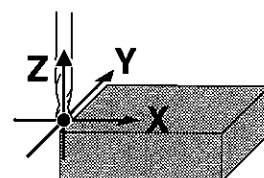

## 2. Setting a workpiece coordinate system using G54 to G59

This method is used to set up to six workpiece coordinate origin points and select a coordinate system from among these by means of the program.

The workpiece coordinate systems 1 through 6 are set by specifying the amount of shift (the amount of workpiece origin point offset) from the machine coordinate origin point to the workpiece coordinate origin point. Each workpiece coordinate system is set using the MDX-650/500's display. (Refer to the "User's Manual 3 Cutting Using NC-Codes" for information on making this setting.)

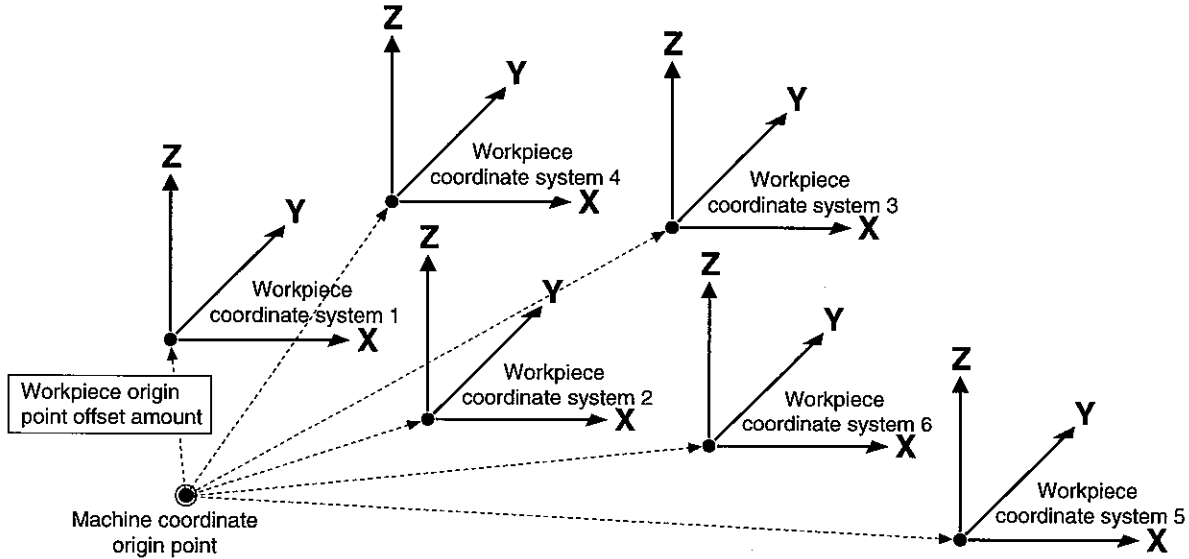

It is also possible to shift the six set workpiece coordinates by a desired distance at one time. Because the workpiece origin point is offset, this is called EXOFS (external workpiece origin point offset amount). EXOFS is set with G10 or by using the MDX-650/500's display. (Refer to the "User's Manual 3 Cutting Using NC-Codes" for information on how to make the setting on the MDX-650/500.)

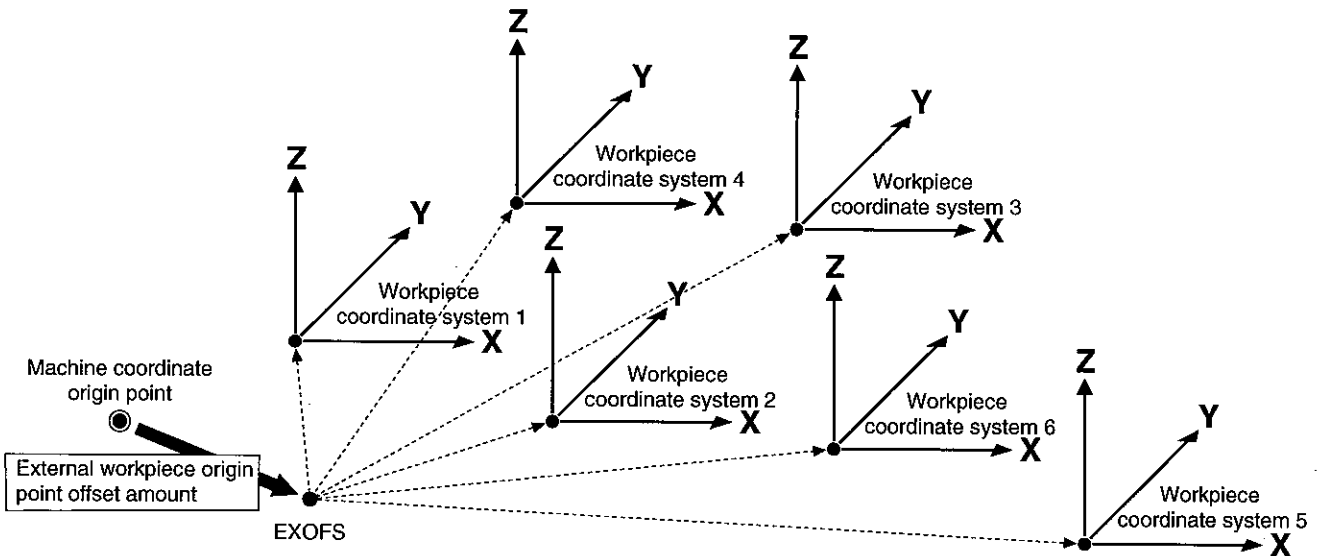

G10 can be used to set not only the amount of shift for all workpiece coordinate systems, but also amounts of offset for each individual workpiece coordinate system.

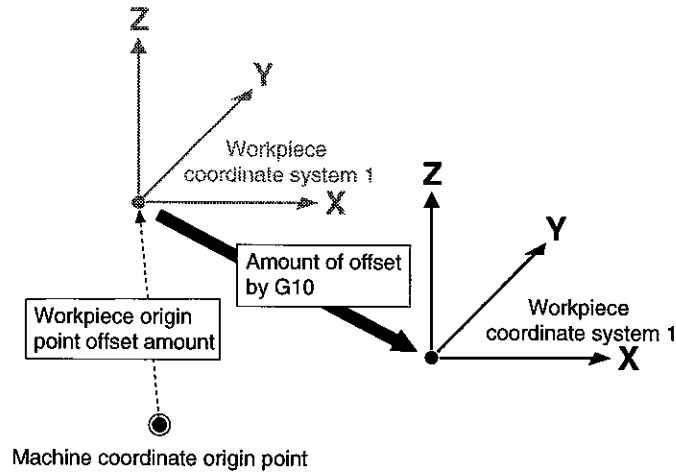

Selecting any of the workpiece coordinate systems from G54 to G59 and executing G92 causes the following to occur.

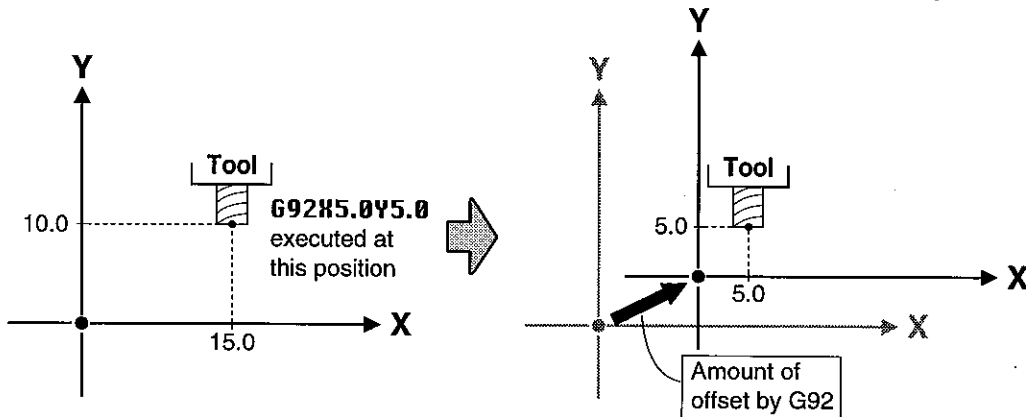

Because G92 sets the current tool position to a desired coordinate value, the workpiece coordinate system selected at that time comes to have a new origin point. The distance between the origin coordinate points before and after G92 is specified (that is, the amount of shift of the coordinate system) is added to each workpiece origin point offset amount. This causes the workpiece coordinate systems from G54 to G59 to be shifted by the same distance.

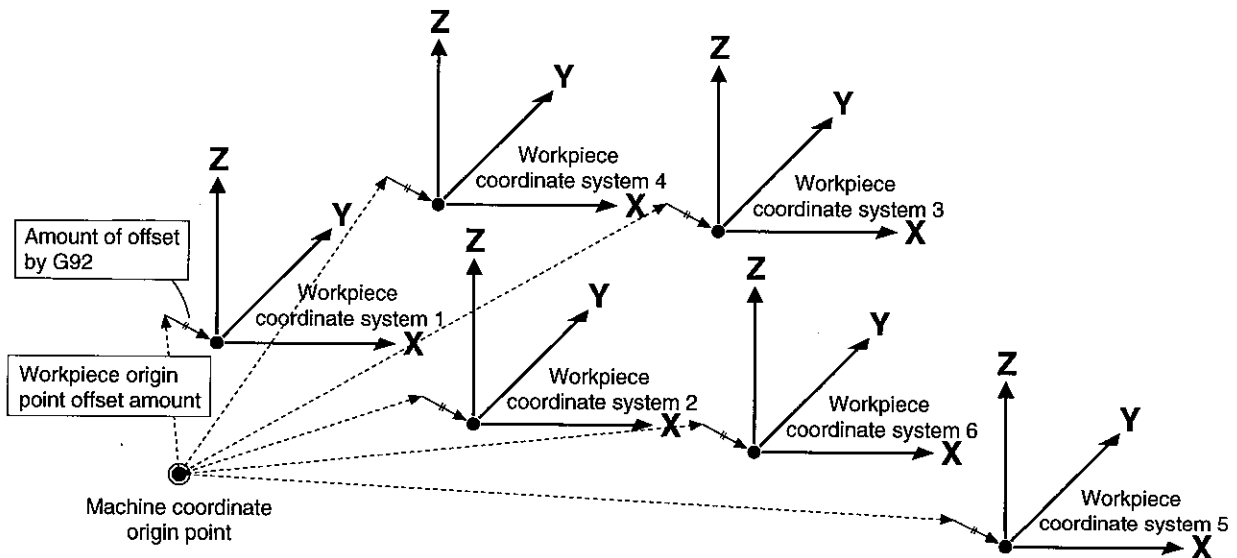

## Setting Coordinate Values (Amount of Movement)

The addresses “X, Y, and Z” or “I, J, and K” are used, followed by the coordinate specification.

- X, Y, Z, and A:** These specify coordinate values for positioning (G00), linear interpolation (G01), and the like. X, Y, and Z represent the coordinates for the X, Y, and Z axes, respectively. It is not necessary to specify all three. As an example, if you want to leave the Y and Z axes as they are, and shift only the X axis by 10 mm, “G00X10.0” should be input. Also, A represents the angle of the rotation axis. For example, to rotate the rotation axis by 90 degrees, use “A90.0.” Note that you cannot specify Y and A at the same time.
- I, J, and K:** These specify the center point for circular interpolation (G02 and G03). I, J, and K represent the movement for the X, Y, and Z axes from the current tool position, respectively. Another method of circular interpolation involves specifying the radius. Refer to “G02 and G03 Circular Interpolation” for details.

### Absolute and Incremental

There are two types of coordinate specifications: absolute and incremental. These are toggled by G90 and G91.

The figure below shows the difference between absolute and incremental specifications on an X-Y plane. Absolute specifications indicate the position as the distance from the workpiece coordinate origin, whereas incremental specifications indicate the amount of movement from the current position.

Programming that specifies absolute coordinates is called “absolute programming,” and programming which specifies incremental coordinates is termed “incremental programming.”

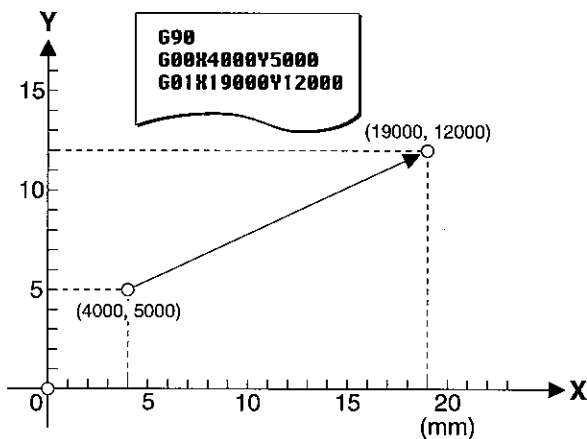

**Absolute**

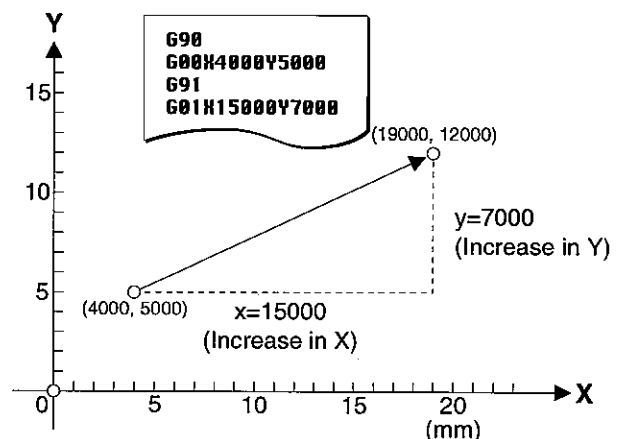

**Incremental**

The settings for G90 or G91 made on the MDX-650/500 remain in effect unless changed by programming.

There are no special rules for deciding when to use an absolute or incremental program. Examine the drawing and choose the one which makes for the simplest program.

## Setting the Measurement Unit

G20 and G21 can be used to set the measurement unit used for movement, feed rate, and offset amounts.

**G20:** Inch input

**G21:** Millimeter input

Either G20 or G21 is set at the start of the program, before setting the coordinate system. G20 and G21 should not be changed during the course of a program. If the unit is not set by programming, the setting made on the MDX-650/500 is used.

The minimum units differ for inch input and millimeter input.

	Minimum units		
Inch input	0.0001 in.		
Millimeter input	0.001 mm		
	Command	G20	G21
Movement	<b>G00X10.0</b>	10 in.	10 mm
	<b>G00X10000</b>	1 in.	10 mm
Feed rate	<b>F60.0</b>	60 inch/min.	60 mm/min.
	<b>F45000</b>	4.5 inch/min.	45 mm/min.
Offset amounts	<b>G10P01R10.0</b>	10 in.	10 mm
	<b>G10P01R10000</b>	1 in.	10 mm

## Real-number Entry and Integer Entry

Movement amount (length), feed rate, and time may be input using either real-number entry or integer entry.

Input of a number which contains a decimal point (for example "10.0" or "10.") is called real-number entry, and input of a number without a decimal point is called integer entry. A value such as "10.0" where the portion to the right of the decimal point is zero may be abbreviated to "10." with no change in value.

When real-number entry is used, the numerical value is interpreted as being in the measurement unit that has been set. When integer entry is used, the numerical value is interpreted as being the minimum unit of the measurement unit that has been set. Some examples of this are as follows.

Amount of movement (length)	<b>X10.0</b>	10 mm or 10 in.*
	<b>X1000</b>	1 mm or 0.1 in.*
Feed rate	<b>F60.0</b>	60 mm/min. or 60 inch/min.*
	<b>F120000</b>	120 mm/min. or 12 inch/min.*
Time	<b>G04X10.0</b>	10 sec. dwell
	<b>G04X1000</b>	10 sec. dwell
Angle	<b>A180.0</b>	180°
	<b>A1800</b>	1.8°

\* The measurement unit is set by G20 (inch input) or G21 (millimeter input).

\* If the unit is not set by programming, the setting made on the MDX-650/500 is used.

There are two types of methods for setting the speed of the spindle motor: setting as an rpm value, and setting as a numerical code. See "Spindle Speed Function (S Function) for details.

## ***Program Number***

A main program or subprogram calls and executes another program by specifying a program number. The program number appears at the start of the program.

To specify a program number, enter "O" (the letter "oh") followed by the four- or eight-digit integer value for the program number. The range for program numbers is from 0001 to 9999 when four-digit numbers have been specified, or from 00000001 to 99999999 when eight-digit numbers have been specified. You cannot enter "0" (zero) for a program number.

The number of digits employed to specify numbers is set before sending on the MDX-650/500. For more information on how to make the setting, refer to "User's Manual 3 — Cutting Using NC Codes."

The section that extends from the place where the program number is input to an M02, M30, or M99 is recognized as one program (or subprogram). M02 or M30 is used to indicate the end of a main program, and M99 is used to signal the end of a subprogram.

## ***Sequence Numbers***

A sequence number is an integer number for a block. It is specified at the start of the block.

A sequence number may either be present or absent from any or all blocks. There is also no need for sequence numbers to be consecutive, or to be arranged in order from smaller to larger numbers. However, consecutive sequence numbers are customarily used to mark critical places within a program.

Enter "N," followed by the four- or eight-digit integer value for the sequence number. The range for sequence numbers is from 0001 to 9999 when four-digit numbers have been specified, or from 00000001 to 99999999 when eight-digit numbers have been specified.

A sequence number cannot be substituted for a program number.

The number of digits employed to specify numbers is set before sending on the MDX-650/500. For more information on how to make the setting, refer to "User's Manual 3 — Cutting Using NC Codes."

## ***Optional Block Skip***

This function makes it possible to skip over a desired block within a program. Optional block skip is specified at the start of the program.

Enter a "/" (slash) at the start of the block.

The setting for enabling or disabling block skip is made on the MDX-650/500. (Refer to "User's Manual 3 -- Cutting Using NC Codes.")

## Positioning (G00)

This moves in a straight line at maximum speed from the current tool position to the specified point. The word for positioning is **"G00."** The addresses X, Y, and Z are used to specify the destination point. When X, Y, and Z are all specified, the three axes move simultaneously.

If the tool path is blocked by the workpiece or another object during movement, it is necessary to take steps to prevent the tool from striking the object, and one way to do this is to move each axis one at a time. An example of this would be to use the absolute specification **"G00Z5000"** to raise the tool, followed by **"G00X1000Y1000"** for horizontal movement.

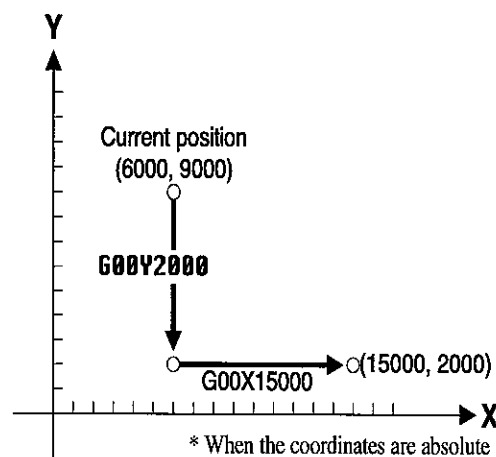
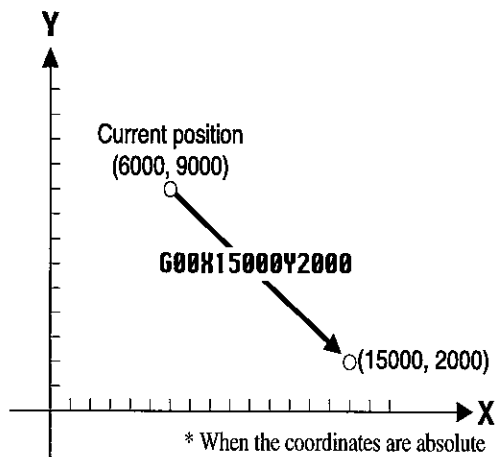

## Linear Interpolation (G01)

This cuts in a straight line from the current position to the specified point. The word for linear interpolation is **"G01."** The addresses X, Y, and Z are used to specify the destination point. When X, Y, and Z are all specified, the three axes move simultaneously.

*G01 does not include the function for starting the spindle motor.* This means that if the spindle motor is not already turning, the M03 word must be given beforehand to start it.

In actual cutting, compensation for the tool diameter is required. Refer "G40, G41 and G42 Cutter Compensation" for more information on compensation of the tool diameter.

## Circular Interpolation (G02 and G03)

This cuts a circular shape from the current position to the specified point. The words for circular interpolation are **"G02"** and **"G03."** Any address of the set X, Y, and Z is used to specify the destination coordinates, and any address of the set I, J, and K is used to specify the center of the circle. I, J, and K always specify the movement distance (incremental value) to the centerpoint of the circle or arc, with no regard for G90 or G91.

*G02 and G03 do not include the function for starting the spindle motor.* This means that if the spindle motor is not already turning, the M03 word must be given beforehand to start it.

G02 and G03 interpolate in different directions — clockwise for G02 and counterclockwise for G03.

Circular interpolation can be carried out on any of the two-dimensional planes — the X-Y plane, the Z-X plane, or the Y-Z plane. The desired plane is specified with G17 (X-Y plane), G18 (Z-X plane), or G19 (Y-Z plane). See "G17, G18 and G19 Plane" for the details of plane specification.

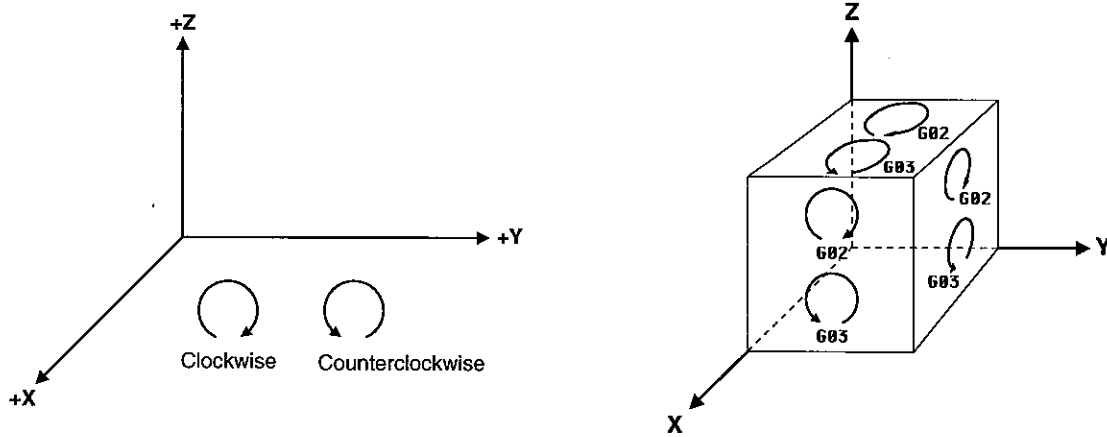

Even when the point for the destination and the center of the circle are identical, circular interpolation is carried out as shown below according to the direction of interpolation.

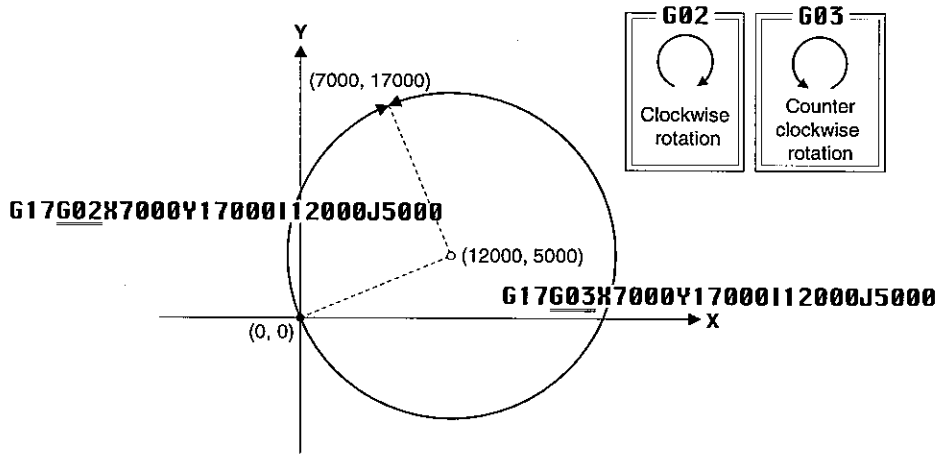

There is another method, which involves specifying the radius of the circle instead of specifying the circle's center point. This method is convenient because numerical values read from the drawing can be used directly.

Two circles with identical radii and passing through two points exist. This means that if the interpolation direction, radius of the circle, and point for the destination of interpolation have been specified, there are two circles. These two circles can be differentiated by specifying a positive value for the radius if the center angle is 180 degrees or less, and a negative radius if the center angle exceeds 180 degrees.

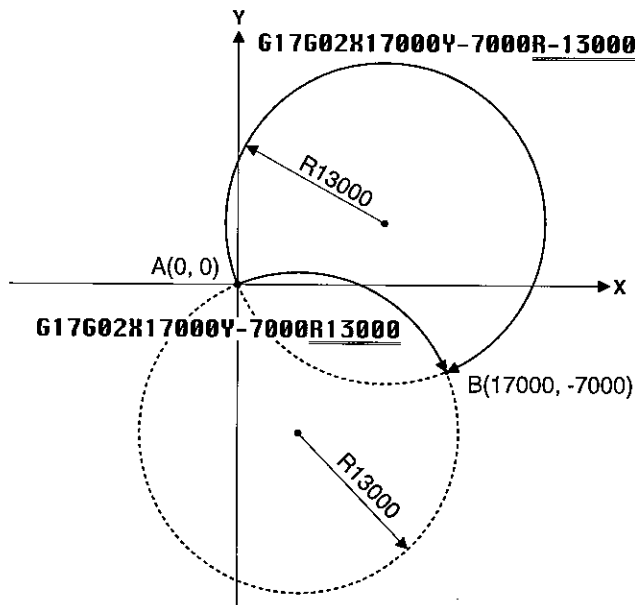



## Cutter Compensation (G40, G41 and G42)

The movement of the tool specified by the program is the path taken by the center of the tool. Because the tool has a certain thickness (i.e., a certain diameter), it will over-cut by an amount equal to its radius if the coordinates on the drawing are input just as they are. To cut a shape as specified by the drawing, the tool must be made to move at a place which shifted away by a distance equal to the tool radius. This is called the "tool-diameter offset."

Using this function makes it possible to input the values from the drawing as coordinate values (or amounts of movement) with no need for modification, thus facilitating programming. Also, if cutting is to be performed with a tool that has a different tool diameter, it is only necessary to change the amount of offset.

The words for cutter compensation are "G40," "G41," and "G42."

**G40:** Cancel cutter compensation

**G41:** Cutter compensation -- left

**G42:** Cutter compensation -- right

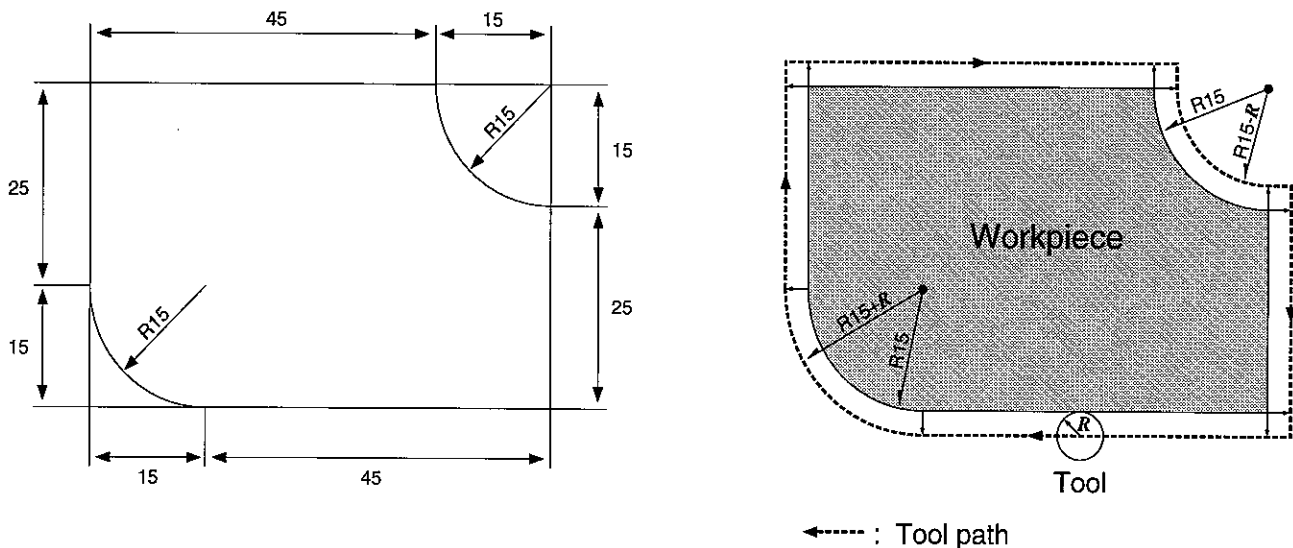

## Feed Rate

This determines the feed rate for the workpiece and the spindle. The F function is used to make the setting.

The feed rate generally varies according to the cutting parameters (such as the spindle speed, tool diameter, and workpiece material).

The F function is activated at the start of the block in which it is specified.

The feed rate is specified as a real or integer value following the "F."

**F100.0** Feed rate set at 100 mm/min. (when millimeter input is used)

**F100000** Feed rate set at 100 mm/min. (when millimeter input is used)

### Feed Rate Override

"Feed rate override" refers to manually changing the feed rate specified by the program. This is mainly used to adjust the feed rate during cutting. This function may or may not be supported, depending on the machine. Refer to the "User's Manual 3 Cutting Using NC-Codes" for information on how to make this setting.

## *Spindle Motor Control (M03 and M05)*

These turn the spindle motor on or off. The M function is used for this.

M03 and M05 are used to control the spindle motor. M03 starts rotation of the spindle, and M05 stops it.

These functions are activated at the end of the block in which they are specified together.

## *Spindle Motor Speed*

The S function is used to set the speed for the spindle motor.

The S function does not include the function for starting the spindle motor. It functions only when the spindle has been started with M03, or when the spindle is already turning.

This function is activated at the end of the block in which it is specified.

## *Fixed Cycle*

The fixed cycle (or canned cycle) is a command for executing a series of pre-established operations for cutting, such as drilling.

This command can execute several blocks of cutting operations in a single block, thereby simplifying programming. This also reduces the amount of data.

See "Fixed Cycle (Canned Cycle) G80, G81, G82, G85, G86 and G89" for details of the specifications for the fixed cycle.

## *Program-related Errors*

An error is generated when an unsuitable value has been set for a parameter, or when the MDX-650/500 cannot interpret the program.

Only error messages related to programming are described in this manual.

### **Errors Occurring During Program Execution**

When an error occurs, operation pauses and an error message is displayed.

The cutting operation can be continued as-is after an error has been displayed, but this is not recommended because operation following the occurrence of an error may not be correct. Instead, stop program execution and correct the place where the error was generated.

Error message	Description
Bad Parameter	The value of a parameter exceeds the allowable range, or the value of the radius for circular interpolation or the amount of offset is not correct.
Address Undefined	Only a parameter has been set. The code which specifies the parameter has not been set.
Parameter Undefined	A parameter has not been set.
Code Cannot Execute	This is displayed when an attempt was made to execute an unrecognizable command, when cutter compensation was started while in the circular interpolation mode, or when an attempt was made to execute a command which cannot be used during tool-diameter or tool-length compensation.
Program Number Not found	The program number specified by M98 could not be found.
Sub-Program Nest Over	An attempt was made to call a fifth-level subprogram from a fourth-level subprogram of a main program.

Display Operations When an Error Occurs During Program Execution

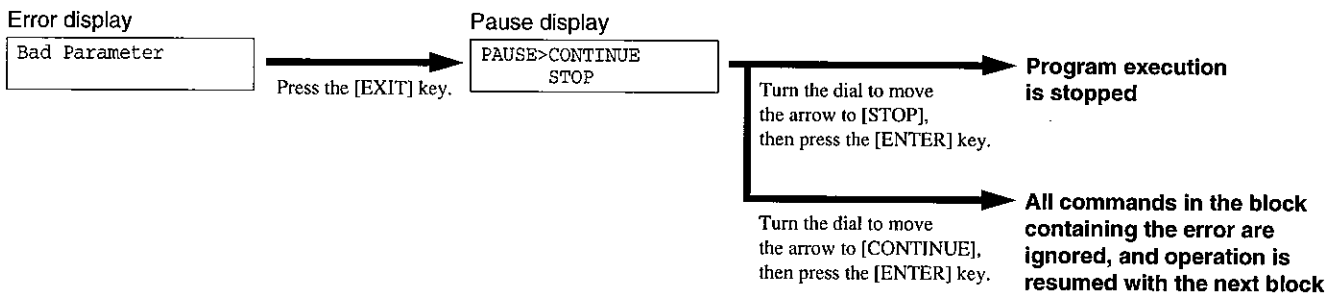

Error While Registering Cutting Data

In the following cases, the display is made when program integrity is analyzed after registering the subprograms. At such times, the message appears for two or three seconds, then reverts to the original screen. Correct the program, then send it again.

Error message	Description
Sub-Program Regist Error	There are more than ten subprograms. The maximum number of subprograms that can be specified in one set of data is ten. After correcting the program, resend the data.
Duplicate Sub-Program Number	The program contains multiple subprograms with the same program number. The same program number may not be set for more than one subprogram within a single set of data. After correcting the program, resend the data.

# Sample Program

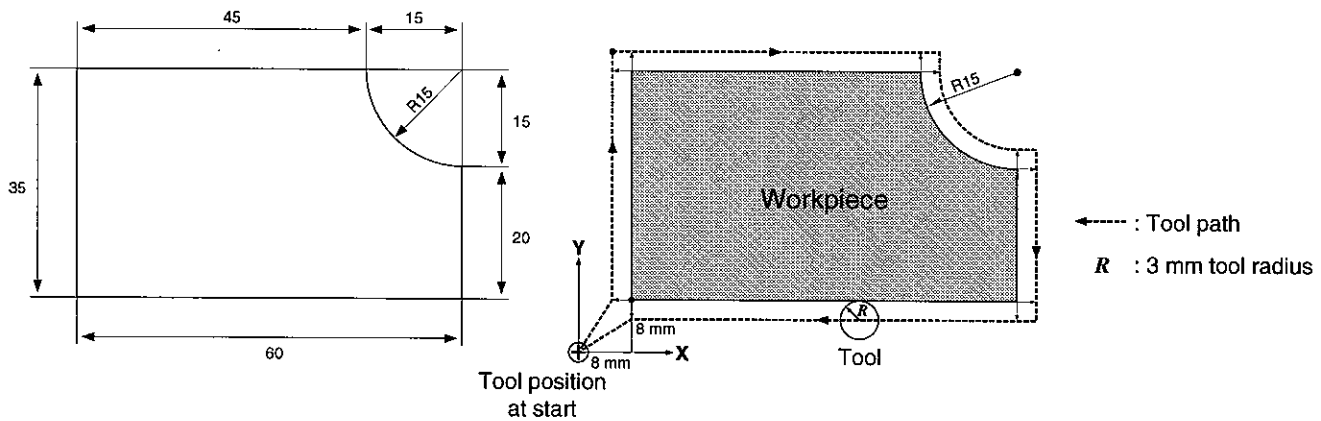

<b>%</b>	Data start
<b>O0001</b>	Program number
<b>N01 G91</b>	Incremental programming
<b>N02 G21</b>	Set millimeter input
<b>N03 G92X0Y0Z0</b>	Set workpiece coordinate origin point
<b>N04 G10P01R3.0</b>	Set 3 mm of offset for offset number 1
<b>N05 G00Z5.0</b>	Move tool to position of 5 mm on Z axis (X0Y0 unchanged)
<b>N07 F300.0S6000M03</b>	Set motor speed to 6,000 rpm and feed rate to 300 mm/min., and rotate spindle
<b>N06 G17G41D001G00X8.0Y8.0</b>	Start cutter compensation and move tool to X-axis 8 mm and Y-axis 8 mm
<b>N08 G01Z-7.0</b>	Linear interpolation to -7 mm on Z axis
<b>N09 G01Y35.0</b>	Linear interpolation to 35 mm on Y axis
<b>N10 X45.0</b>	Linear interpolation to 45 mm on X axis
<b>N11 G03X15.0Y-15.0I15.0</b>	Circular interpolation (counterclockwise) to position X 15 mm Y -15 mm from current tool position
<b>N12 G01Y-20.0</b>	Linear interpolation to -20 mm on Y axis
<b>N13 X-60.0</b>	Linear interpolation to -60 mm on X axis
<b>N14 Z7.0</b>	Linear interpolation to 7 mm on Z axis
<b>N15 G40G00X-8.0Y-8.0</b>	Cancel cutter compensation and return to start point
<b>N16 M05</b>	Main spindle rotation halt
<b>M02</b>	Program end
<b>%</b>	Data end

\* The example program shown above is for when using ISO or ASCII as the code.

# Part 2 Reference

## How to Read Part 2

### [ Preparatory Functions (G Functions) ]

Word **G00** Positioning Word function

Words in square brackets (“[ ]”) may be omitted. Parameters are given in italics (such as “x,” “y,” and “feed rate”). The words enclosed in curly brackets (“{ }”) are a range of available selections. Any one may be chosen.

Format  
G00[H x][Y y][Z z]

Parameter	Function	Acceptable range	Effective range
x	Coordinate or movement distance (X axis)	Range 1	Maximum cutting range
y	Coordinate or movement distance (Y axis)	Range 1	Maximum cutting range
z	Coordinate or movement distance (Z axis)	Range 1	Maximum cutting range

#### Description

This effects movement in a straight line and at maximum speed from the current tool position to the specified coordinate point. When incremental programming is used, the tool moves the specified movement distance. G00 ignores any set feed rate, and always effects movement at maximum speed. When “MOVE OVER RIDE” has been set on the MDX-63/500, however, operation is according to this setting. The destination's coordinates (or movement distances) are specified with addresses X, Y, and Z. It is not necessary to specify values for every one of these addresses. As an example, if only the X axis is specified (e.g., G00X100), the tool moves only along the X axis, with no movement on the Y or Z axes. This is also the case when only the Y axis, Z axis, X and Y axes, Y and Z axes, or Z and Y axes are specified. When addresses X, Y, and Z are all specified, the tool moves along all three axes simultaneously. G00 is also effective outside the block until a word of the same type is encountered. If XxYyZz is specified in the block after specifying G00, with no G01, G02, or G03, linear movement to the specified coordinate is effected. If the tool path is blocked by the workpiece or another object during movement, it is necessary to take steps to prevent the tool from striking the object, and one way to do this is to move each axis one at a time.

This is an explanation of the functions of the word and its parameters, along with cautions or other important points to observe when using.

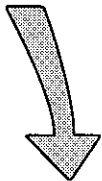

For example,

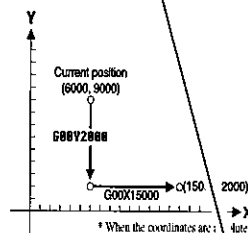
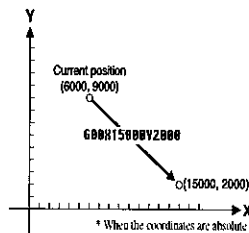

G17 { G02 } [R x][Y y] { [I cx][J cy] }  
G03  
R radius

uses this shorthand form to indicate the following four expressions:

G17G02[R x][Y y][I cx][J cy]  
G17G03[R x][Y y][I cx][J cy]  
G17G02[R x][Y y] R radius  
G17G03[R x][Y y] R radius

The range and functions of a parameter are shown in table form.

“Range 1”, “Range 2” and “Range 3” are shorthand expressions for ranges in which an error does not occur. These correspond to the following ranges.

- Range 1: Integer entry — -83,886,08 to 83,886,08  
Real-number entry — -8388.608 to 8388.608 (when millimeter input is used)  
-838.8608 to 838.8608 (when inch input is used)
- Range 2: -83,886,08 to 83,886,08
- Range 3: -134217728 to 134217728

# [ Preparatory Functions (G Functions) ]

## G00

## Positioning

### Format

**G00**[X *x* ][Y *y* ][Z *z* ][A *a* ]

Parameter	Function	Acceptable range	Effective range
<i>x</i>	Coordinate or movement distance (X axis)	Range 1	Maximum cutting range
<i>y</i>	Coordinate or movement distance (Y axis)	Range 1	Maximum cutting range
<i>z</i>	Coordinate or movement distance (Z axis)	Range 1	Maximum cutting range
<i>a</i>	Angle or movement distance (A axis)	Range 1	Maximum cutting range

### Description

This effects movement in a straight line and at maximum speed from the current tool position to the specified coordinate point. When incremental programming is used, the tool moves the specified movement distance. G00 ignores any set feed rate, and always effects movement at maximum speed. When "MOVE OVER RIDE" has been set on the MDX-650/500, however, operation is according to this setting.

The destination's coordinates (or movement distances) are specified with addresses X, Y, and Z. It is not necessary to specify values for every one of these addresses. As an example, if only the X axis is specified (e.g., G00X100), the tool moves only along the X axis, with no movement on the Y or Z axes. This is also the case when only the Y axis, Z axis, X and Y axes, Y and Z axes, or Z and Y axes are specified. When addresses X, Y, and Z are all specified, the tool moves along all three axes simultaneously.

G00 is also effective outside the block until a word of the same group is encountered. If **X Y Z** is specified in the block after specifying G00, with no G01, G02, or G03, linear movement to the specified point is effected.

If the tool path is blocked by the workpiece or another object during movement, it is necessary to take steps to prevent the tool from striking the object, and one way to do this is to move each axis one at a time.

**Y y** and **A a** cannot be specified at the same time. Specifying the Y axis and the A axis within the same block results in an error.

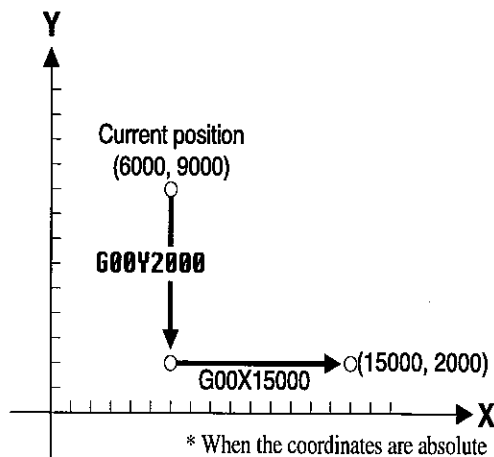
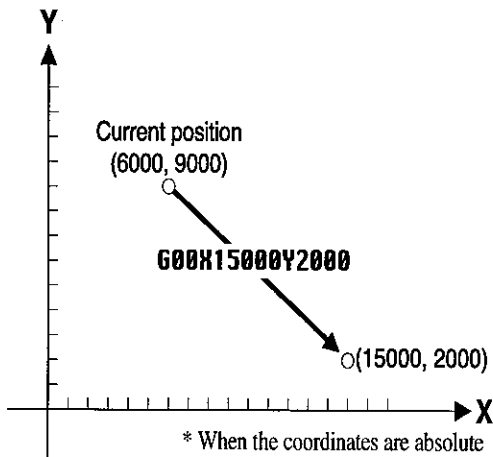

**G01****Linear Interpolation****Format****G01**[*X x*][*Y y*][*Z z*][*A a*]

Parameter	Function	Acceptable range	Effective range
<i>x</i>	Coordinate or movement distance (X axis)	Range 1	Maximum cutting range
<i>y</i>	Coordinate or movement distance (Y axis)	Range 1	Maximum cutting range
<i>z</i>	Coordinate or movement distance (Z axis)	Range 1	Maximum cutting range
<i>a</i>	Angle or movement distance (A axis)	Range 1	Maximum cutting range

**Description**

This effects linear cutting from the current tool position to the specified coordinate. When incremental programming is used, cutting for the specified movement distance is performed.

Cutting is performed at the spindle speed and feed rate that have been specified. Refer to "Feed Function (F Function)" for an explanation of the feed rate and to "Spindle Speed Function (S Function)" for a description of spindle speed.

The destination's coordinates (or movement distances) are specified with addresses X, Y, and Z. It is not necessary to specify values for every one of these addresses. As an example, if only the X axis is specified (e.g., G01X100), the tool moves only along the X axis, with no movement on the Y or Z axes. This is also the case when only the Y axis, Z axis, X and Y axes, Y and Z axes, or Z and Y axes are specified. When addresses X, Y, and Z are all specified, the tool moves along all three axes simultaneously.

G01 is also effective outside the block until a word of the same group is encountered. If **X Y Z z** is specified in the block after specifying G01, with no G00, G02, or G03, linear interpolation to the specified point is effected. This makes it possible to carry out continuous linear interpolation.

G01 does not include the function for starting the spindle motor. If the spindle motor is not already turning, the M03 word should be given beforehand to start it.

The specified tool movement is the path followed by the center of the tool. Programming should be done so that the tool passes over a path which is offset by a distance equal to the radius of the tool.

**Y y** and **A z** cannot be specified at the same time. Specifying the Y axis and the A axis within the same block results in an error.

**G02 and G03****Circular Interpolation****Format**

$$G17 \begin{Bmatrix} G02 \\ G03 \end{Bmatrix} [X_x][Y_y] \begin{Bmatrix} I cx \\ J cy \\ R radius \end{Bmatrix}$$

$$G18 \begin{Bmatrix} G02 \\ G03 \end{Bmatrix} [X_x][Z_z] \begin{Bmatrix} I cx \\ K cz \\ R radius \end{Bmatrix}$$

$$G19 \begin{Bmatrix} G02 \\ G03 \end{Bmatrix} [Y_y][Z_z] \begin{Bmatrix} J cy \\ K cz \\ R radius \end{Bmatrix}$$

Parameter	Function	Acceptable range	Effective range
x	Coordinate or movement distance (X axis)	Range 1	Maximum cutting range
y	Coordinate or movement distance (Y axis)	Range 1	Maximum cutting range
z	Coordinate or movement distance (Z axis)	Range 1	Maximum cutting range
cx	Movement distance to circle (arc) center (X axis)	Range 1	Maximum cutting range
cy	Movement distance to circle (arc) center (Y axis)	Range 1	Maximum cutting range
cz	Movement distance to circle (arc) center (Z axis)	Range 1	Maximum cutting range
radius	radius	Range 3	Maximum cutting range

**Description**

This cuts an arc at the specified feed rate and spindle speed from the current tool position to the specified point. Circular interpolation can be carried out only on the X-Y plane, Z-X plane, or Y-Z plane.

The specification for the two-dimensional plane is made with G17, G18, or G19. These specify the X-Y plane, Z-X plane, and Y-Z plane, respectively. The specification for the X-Y plane is enabled when the machine's power is switched on.

To specify the destination point for interpolation, use is made of addresses X and Y for G17, X and Z for G18, and Y and Z for G19.

The center point for the arc is specified with addresses I and J for G17, I and K for G18, and J and K for G19. I, J, and K always specify the movement distance (incremental value) to the centerpoint of the circle or arc, with no regard for G90 or G91. It is also possible to specify the radius R for the arc instead of using I, J, or K.

When the point of the current tool position is specified as the destination for interpolation, a circle with a center angle of 360° is cut.

G02 and G03 differ in the direction of interpolation for the arc (i.e., the direction of tool movement). G02 performs clockwise circular interpolation, whereas G03 performs counterclockwise interpolation.

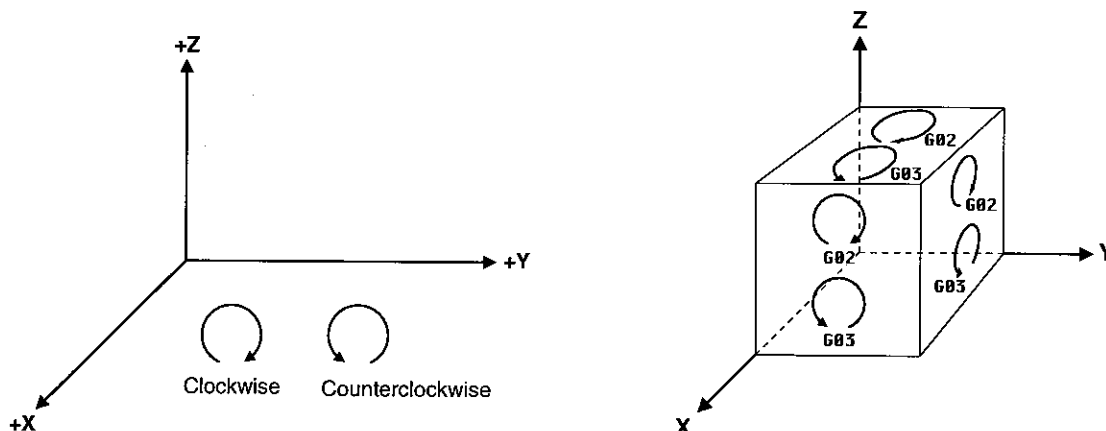



Even when the point for the destination and the center of the circle are identical, circular interpolation is carried out as shown below according to the direction of interpolation.

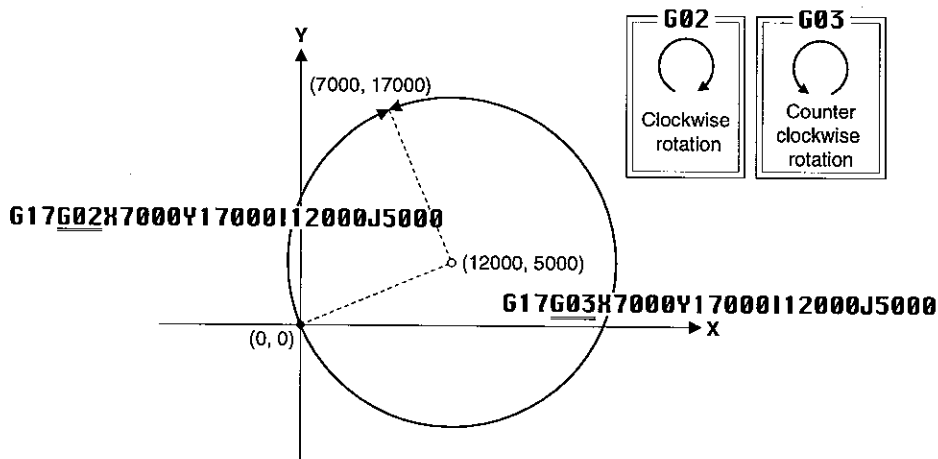

Two circles with identical radii and passing through two points exist. This means that if the interpolation direction, radius of the circle, and point for the destination of interpolation have been specified, there are two circles. These circles can be differentiated by specifying a positive value for the radius if the center angle is 180 degrees or less, and a negative radius if the center angle exceeds 180 degrees.

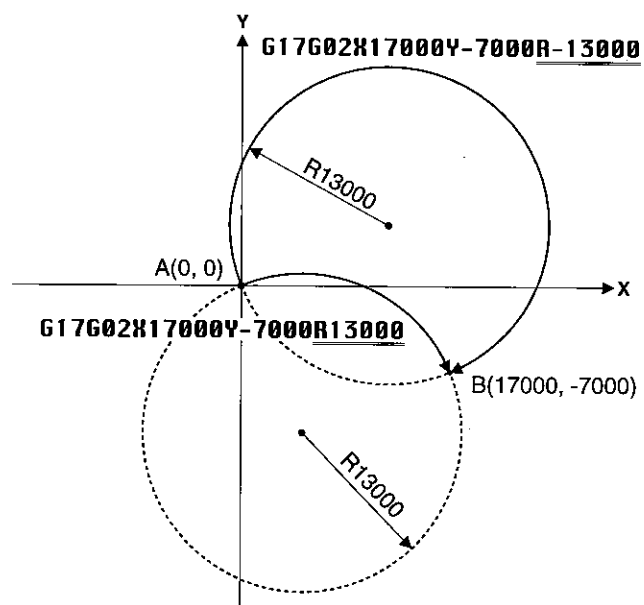

G02 and G03 are also effective outside the block until a word of the same group (G00, G01, G02, or G03) is encountered. G17, G18, G19 also remain effective even outside the block until a word of the same group (G17, G18, or G19) is specified. G02 and G03 do not include the function for starting the spindle motor. This means that if the spindle motor is not already turning, the M03 word must be given beforehand to start it.

The specified tool movement is the path followed by the center of the tool. Please make calculations to have the tool pass through a location that is offset by a distance equal to its radius, and then carry out the programming accordingly. An error is generated when an attempt is made to execute a code for starting cutter compensation (G41 or G42) while in the circular interpolation mode.

# Helical Interpolation

When an axis is added to the coordinate point for the destination of interpolation, movement in the form of a helix is carried out, as shown below. This is called helical interpolation. A three-dimensional curve is cut by performing a synchronized linear operation along the added axis while carrying out circular interpolation.

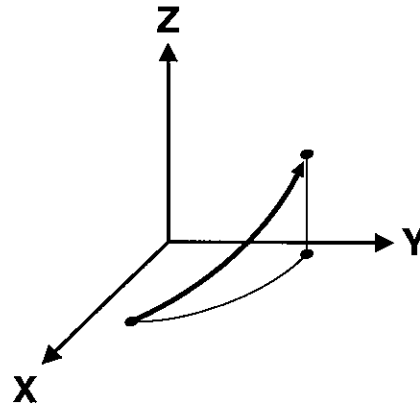

## Format

**G17** { **G02** } [X x ] [Y y ] { [I cx ] [J cy ] } [R radius ] } Z z

**G18** { **G02** } [X x ] [Z z ] { [I cx ] [K cz ] } [R radius ] } Y y

**G19** { **G02** } [Y y ] [Z z ] { [J cy ] [K cz ] } [R radius ] } X x

Parameter	Function	Acceptable range	Effective range
x	Coordinate or movement distance (X axis)	Range 1	Maximum cutting range
y	Coordinate or movement distance (Y axis)	Range 1	Maximum cutting range
z	Coordinate or movement distance (Z axis)	Range 1	Maximum cutting range
cx	Movement distance to circle (arc) center (X axis)	Range 1	Maximum cutting range
cy	Movement distance to circle (arc) center (Y axis)	Range 1	Maximum cutting range
cz	Movement distance to circle (arc) center (Z axis)	Range 1	Maximum cutting range
radius	radius	Range 3	Maximum cutting range

**G04****Dwell****Format****G04[X *time(X)* ]****G04[P *time(P)* ]**

Parameter	Function	Acceptable range	Effective range
<i>time(X)</i>	Dwell time	Range 1	-
<i>time(P)</i>	Dwell time	Range 2	-

**Description**

G04 specifies the time interval for moving from the previous block to the next block. G04 is normally specified as a single block all by itself.

G04 is used with the aim of cutting a precise angle, ensuring precision when cutting the bottom of a drilled hole, or the like.

The desired dwell time is specified after X or P. X and P are functionally equivalent, and may be used interchangeably. A numerical value (real or integer) is used to specify the dwell time. The specified time is in seconds when a real number is used, and in milliseconds when an integer is used.

**G04X10.0**

10-second dwell

**G04X10000**

10-second dwell (in millisecond units)

# G10

# Data Setting

## Format

**G10L2P** *coordinate* [**X** *x*][**Y** *y*][**Z** *z*][**A** *a*]  
**G10**[**P** *number* ][**R** *offset* ]

Parameter	Function	Acceptable range	Effective range
<i>coordinate</i>	Work coordinate	Range 2	0 to 6
<i>x</i>	Coordinate or movement distance (X axis)	Range 1	Maximum cutting range
<i>y</i>	Coordinate or movement distance (Y axis)	Range 1	Maximum cutting range
<i>z</i>	Coordinate or movement distance (Z axis)	Range 1	Maximum cutting range
<i>number</i>	Offset number	Range 2	1 to 3
<i>offset</i>	Amount of offset	0 to 10 [mm] or 0 to 0.39 inch	0 to 10 [mm] or 0 to 0.39 inch
<i>a</i>	Angle or movement distance (A axis)	Range 1	Maximum cutting range

## Description

This sets the amount of shift for workpiece coordinate systems as well as the amount of offset used by the cutter compensation and tool-length compensation.

### Setting the Amount of Shift for Workpiece Coordinate Systems

This sets the amount of shift for workpiece coordinate systems 1 to 6 of G54 and G59. The format for setting the amount of shift is as follows.

**G10L2P** *coordinate* [**X** *x*][**Y** *y*][**Z** *z*][**A** *a*]

The number of the workpiece coordinate system (1 to 6) is specified by *coordinate*. Specifying "0" causes the amount of shift (EXOFS) to be set for all workpiece coordinate systems.

The amounts of shift for the coordinate system are specified by *x*, *y*, *z* and *a*. When "0" has been specified for *coordinate*, the value is set with the machine coordinate origin taken as 0. When *coordinate* specifies the number of a workpiece coordinate system (1 to 6), the value is set with a point shifted from the machine coordinate origin by a distance equal to EXOFS taken as 0.

Refer to "Part1\_Coordinate Systems" for detailed information about coordinate systems.

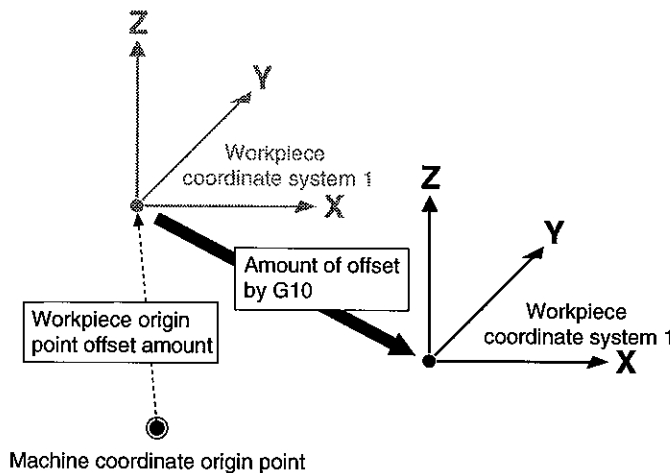

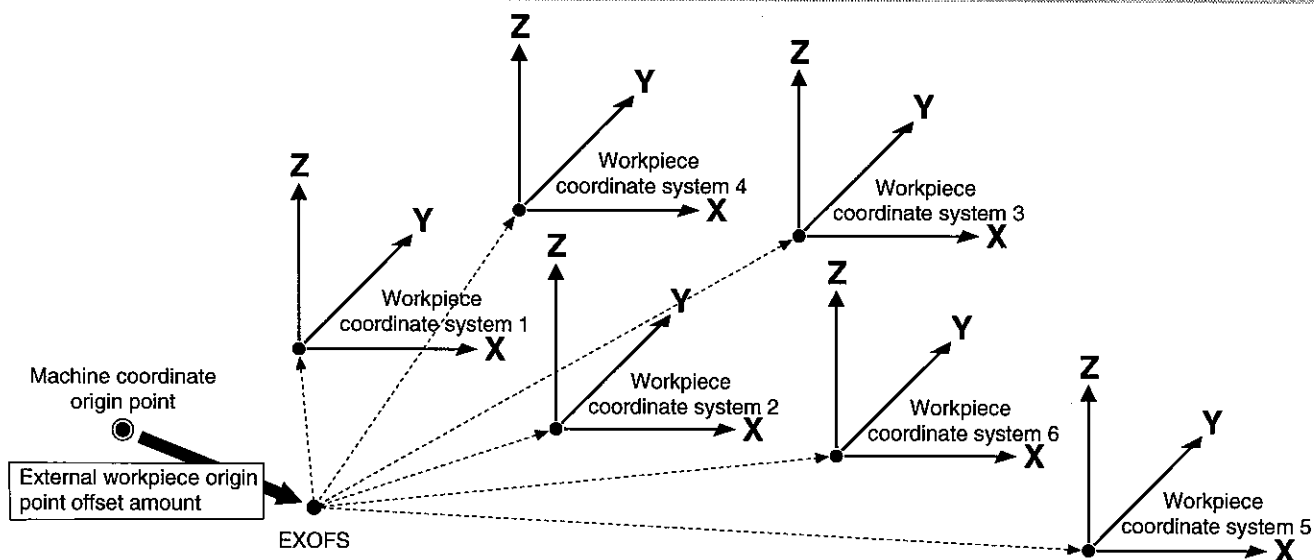

## Setting the Amount of Offset

This sets the amount of offset used by the cutter compensation (G41 and G42). The format for setting the amount of offset is as follows.

**G10P** *number* [**R** *offset* ]

The offset number for which an amount of offset is to be specified is indicated by *number*. An integer from 1 to 3 may be specified. The amount of offset is indicated by *offset*. A setting within the range of 0 to 10.00 mm (or within the range of 0 inch to 0.39 inch for inch input) may be made.

The amount of offset can be specified using the LCD panel on the MDX-650/500. (Refer to the "User's Manual 3 Cutting Using NC-Codes" for a description of the procedure.)

# G17, G18 and G19

# Plane

## Format

- G17
- G18
- G19

## Description

This specifies a two-dimensional plane for circular interpolation (G02 or G03). G17 specifies the X-Y plane, G18 specifies the Z-X plane, and G19 specifies the Y-Z plane. Each of these is normally used in combination with G02 or G03 in the same block. (Refer to "Circular Interpolation G02 and G03").

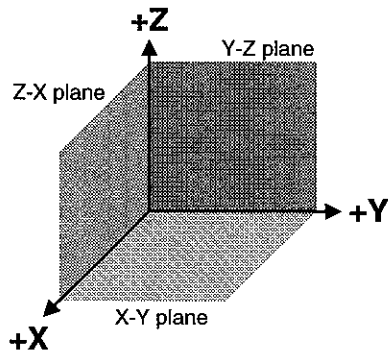

# G20 and G21

# Setting the Measurement Unit

## Format

- G20
- G21

## Description

This sets the measurement unit used for movement, feed rate, and offset amounts. G20 sets inch input, and G21 sets millimeter input. Either G20 or G21 is set at the start of the program, before setting the coordinate system. G20 and G21 should not be changed during the course of a program.

The minimum units differ for inch input and millimeter input.

	Minimum units
Inch input	0.0001 in.
Millimeter input	0.001 mm

Changing the measurement unit results in interpretation as shown below.

	Command	G20	G21
Movement	<b>G00X1.0</b>	1 in.	1 mm
	<b>G00X1000</b>	0.1 in.	1 mm
Feed rate	<b>F60.0</b>	60 inch/min.	60 mm/min.
	<b>F45000</b>	4.5 inch/min.	45 mm/min.
Offset amounts	<b>G10P01R10.0</b>	10 in.	10 mm
	<b>G10P01R10000</b>	1 in.	10 mm

**G39****Corner-offset Circular Interpolation****Format****G39[X x][Y y]**

Parameter	Function	Acceptable range	Effective range
x	Coordinate or movement distance (X axis)	Range 1	Maximum cutting range
y	Coordinate or movement distance (Y axis)	Range 1	Maximum cutting range

**Description**

Corner-offset circular interpolation is a function which performs tool movement at crossover points during cutter compensation by means of circular interpolation. The radius of circular interpolation is the amount of offset (tool radius).

Corner-offset circular interpolation can be executed during cutter compensation, when G41 or G42 has already been executed. The values for x and y specify the direction of movement after corner-offset circular interpolation has been performed.

```

.....
N0132 G17600G41D01X1000Y1000
.....
N0163 G01X17000
N0164 X18000Y7500
.....

```

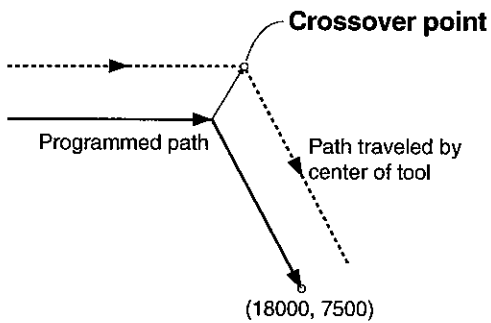

```

.....
N0132 G17600G41D01X1000Y1000
.....
N0163 G01X17000
N0164 G39X18000Y7500
X18000Y7500
.....

```

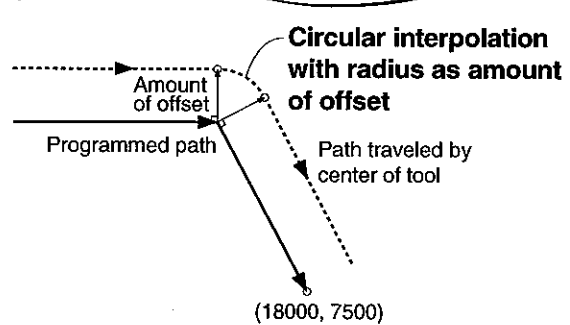

G39 is a word which is effective only within a block. Arc interpolation is used only for corners specified as G39. G39 does not affect G00, G01, G02, or G03.

**G40, G41 and G42****Cutter Compensation****Format**

{ G00 } G40[X x ][Y y ]  
{ G01 }

G17 { G00 } { G41 } D number [X x ][Y y ]  
{ G01 } { G42 }

Parameter	Function	Acceptable range	Effective range
x	Coordinate or movement distance (X axis)	Range 1	Maximum cutting range
y	Coordinate or movement distance (Y axis)	Range 1	Maximum cutting range
number	Offset number	0 to 3	0 to 3

**Description**

The movement of the tool specified by the program is the path taken by the center of the tool. Because the tool has a certain thickness (i.e., a certain diameter), it will over-cut by an amount equal to its radius if the coordinates on the drawing are input just as they are. To cut a shape as specified by the drawing, the tool must be made to move at a place which shifted away by a distance equal to the tool radius. This is called the "tool-diameter offset."

Using this function makes it possible to input the values from the drawing as coordinate values (or amounts of movement) with no need for modification, thus facilitating programming. Also, if cutting is to be performed with a tool that has a different tool diameter, it is only necessary to change the amount of offset.

The words for cutter compensation are "G40," "G41," and "G42."

**G40:** Cancel cutter compensation

**G41:** Cutter compensation -- left

**G42:** Cutter compensation -- right

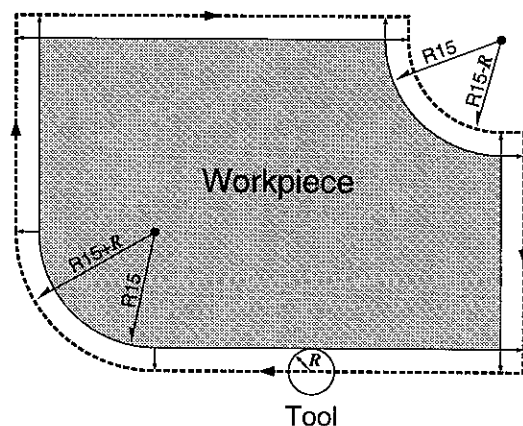
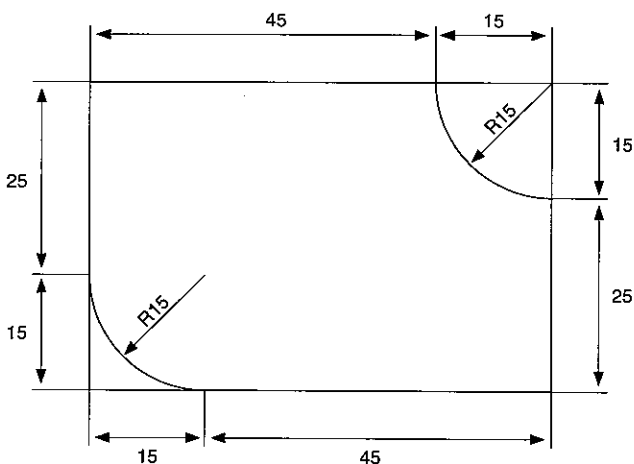

← : Tool path

**Restrictions on Cutter Compensation**

Cutter compensation is subject to the following restrictions.

1. Cutter compensation can be performed only in the XY plane.
2. Do not position two or more blocks without X- and Y-axis motion commands next to each other during tool diameter compensation. It may cause excessive or insufficient cutting depth.
3. No interference check for cutter compensation is performed. However, an error is generated if an attempt is made to machine the inner side of a circle or arc with an amount of offset that is larger than the radius for circular interpolation.



4. When circular interpolation has been specified, an error is generated if cutter compensation is started or canceled. When positioning (G00) or linear interpolation (G01) has been specified, cutter compensation should be started or canceled.
5. When cutter compensation for circular interpolation is performed, parameters cannot be changed using the display with operation paused.
6. When fixed-cycle operation has been specified, executing or canceling cutter compensation causes an error to be generated.
7. Performing any of the following operations or settings during cutter compensation causes an error to be generated.

Changing the offset number : To change the offset number, first cancel cutter compensation. Then execute G41 or G42 again, and change the offset number.

Switching the direction of compensation : When G41 (cutter compensation -- left) has been used, executing G42 causes an error to be generated. Similarly, when G42 (cutter compensation -- right) has been used, executing G41 causes an error to be generated.

Specifying a plane : Executing G17, G18, or G19 causes an error to be generated.

Scaling : Executing G50 or G51 causes an error to be generated.

Fixed cycle : Executing G80, G81, G82, G85, G86, or G89 causes an error to be generated.

Specifying a coordinate system : Executing G10, G54 to G59, or G92 causes an error to be generated.

Calling a subprogram or returning to the main program : Executing M98 or M99 causes an error to be generated.

### Setting the Amount of Offset

The MDX-650/500 allows amounts of offset to be set individually for offset numbers 1 to 3. An amount of offset can be set using either of two methods.

1. Using the display on the MDX-650/500  
The MDX-650/500's LCD screen and control keys are used to set the amount of offset. See the "User's Manual 3 Cutting Using NC-Codes" for a description of the procedure.
2. Using code (G10)

**G10P number[R offset]**

Parameter	Function	Acceptable range	Effective range
<i>number</i>	Offset number	Range 2	1 to 3
<i>offset</i>	Offset value	0 to 10 [mm] or 0 to 0.39 inch	0 to 10 [mm] or 0 to 0.39 inch

Note: The ranges shown above are the ranges where the amount of offset for cutter compensation can be used.

\* If G41 or G42 is used to specify an offset number for which no amount of offset has been set with G10, the value that has been set on the MDX-650/500 is used.

\* An amount of offset of zero is set for offset number 0. The amount of offset for offset number 0 cannot be changed.

### Starting Cutter Compensation

Cutter compensation is started with G41 or G42. G41 performs offset to the left-hand side relative to the direction of forward movement. Similarly, G42 performs offset to the right-hand side relative to the direction of forward movement. The direction of offset cannot be changed while cutter compensation is in progress.

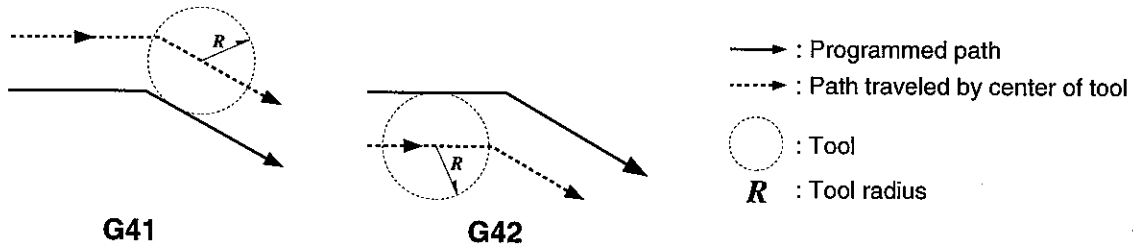

G41 or G42 is specified immediately after positioning (G00) or linear interpolation (G01). Cutter compensation cannot be started with circular interpolation (G02 or G03). Also, compensation on the MDX-650/500 is performed only for the XY plane, and so G17 (setting of the XY plane) is specified immediately after G00 or G01.

As shown in the figure below (on the left-hand side), the tool is shifted to the left or the right by the amount of offset as it moves forward from the starting point. Operation takes place when a command for moving to a block is specified when cutter compensation finishes.

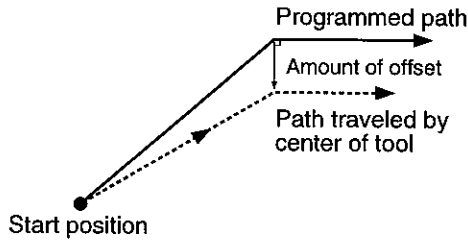

Now let's take a look at tool movement when cutter compensation is started in actual use.

As the following figures show, the shift from the start of offset to the next operation can be classified as travel on the inner side of the program path, travel on the outer side as an obtuse angle, and travel on the outer side as an acute angle. Outer-side travel includes "Type A" and "Type B" paths. The settings for Type A or Type B are made using the MDX-650/500's display. (Refer to the "User's Manual.")

Definitions of "Inner Side" and "Outer Side"

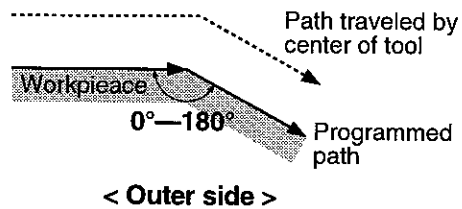
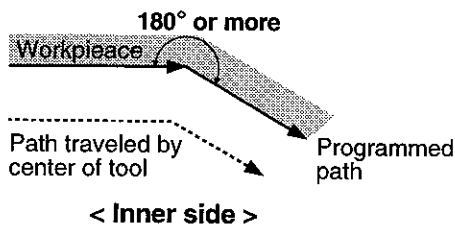

**Inner Side** (180° ≤ a)

From a line to a line

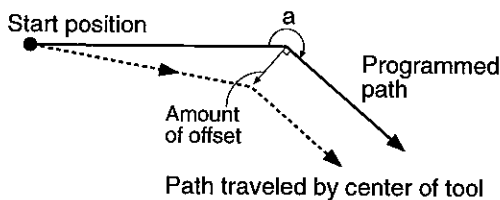

From a line to an arc

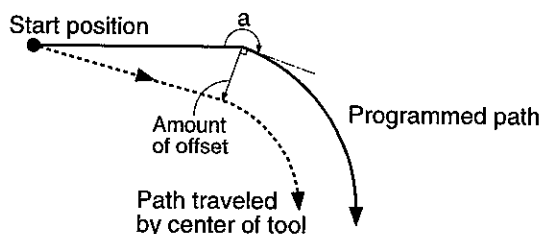

**Outer-side Obtuse Angle** ( $90^\circ \leq a < 180^\circ$ )

**From a line to a line -- Type A**

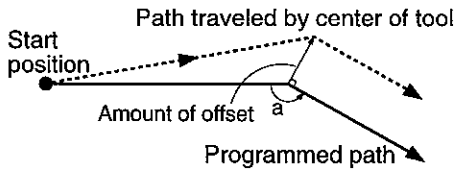

**From a line to an arc -- Type A**

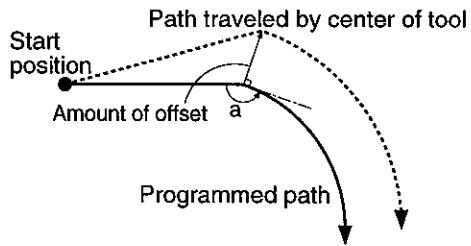

**From a line to a line -- Type B**

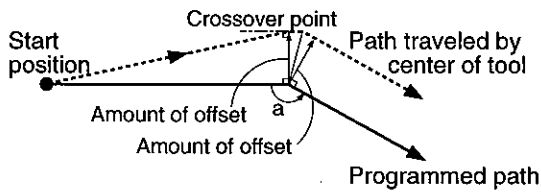

**From a line to an arc -- Type B**

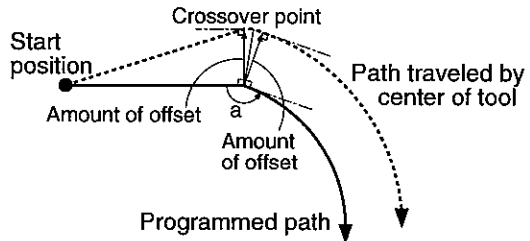

**Outer-side Acute Angle** ( $a < 90^\circ$ )

**From a line to a line -- Type A**

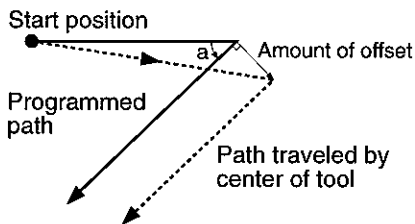

**From a line to an arc -- Type A**

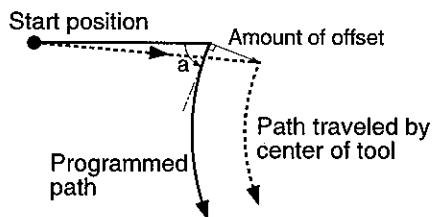

**From a line to a line -- Type B**

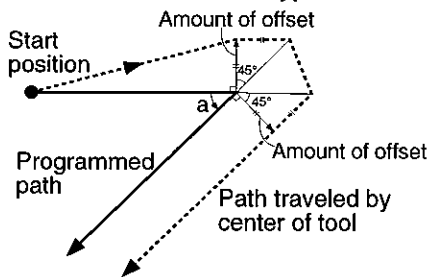

**From a line to an arc -- Type B**

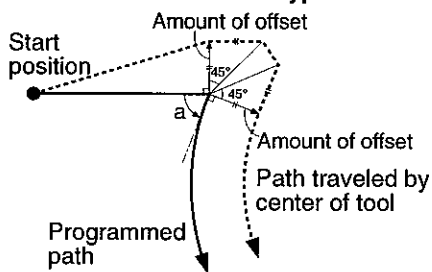

**Exceptions: Acute angles of 1° or less**

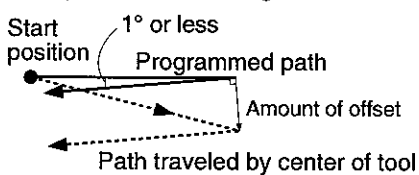

### Operation at Crossover Points During Cutter Compensation

During offset, the tool moves at a position that is always shifted away from the program path by a distance equal to the amount of offset. The figures below show the operation that takes place at a crossover point for a line and another line, a crossover point for a curve and another curve, and a crossover point for a line and a curve.

**Inner Side** ( $180^\circ \leq a$ )

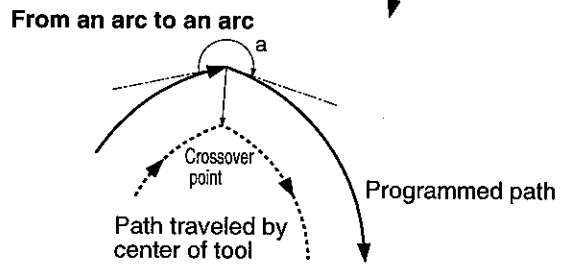
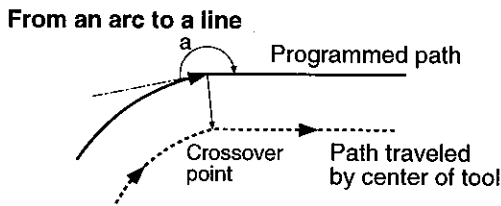
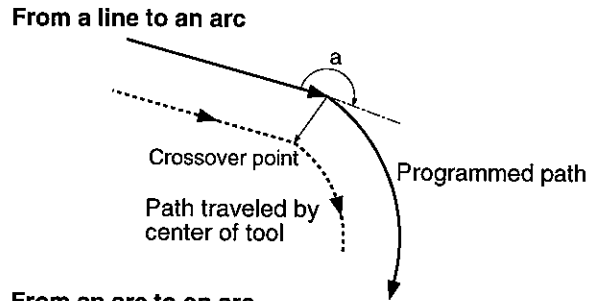
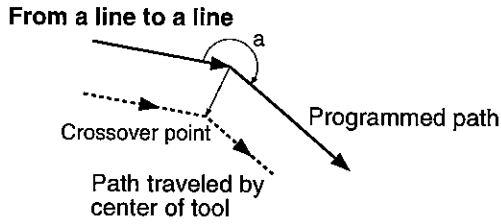

**Exceptions: Inner-side passage of 1° or less (obtuse angle of 359° or more and less than 360°)**

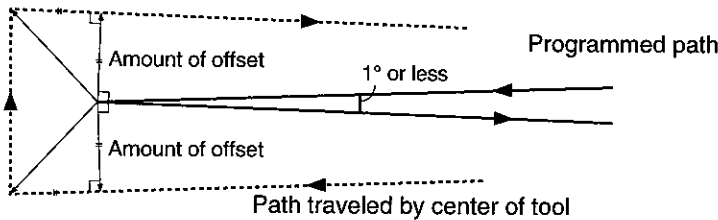

**Outer-side Obtuse Angle** ( $90^\circ \leq a < 180^\circ$ )

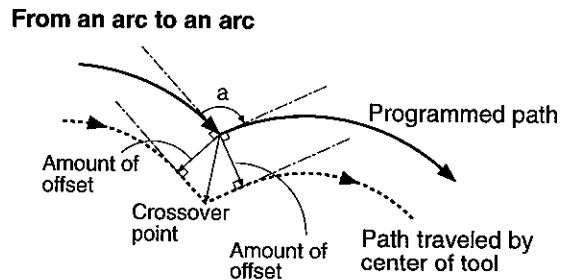
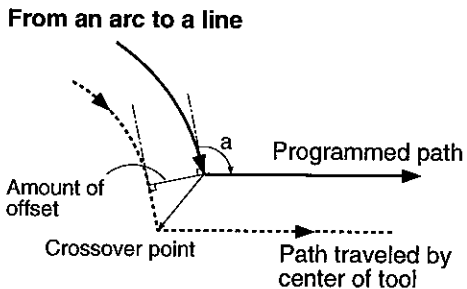
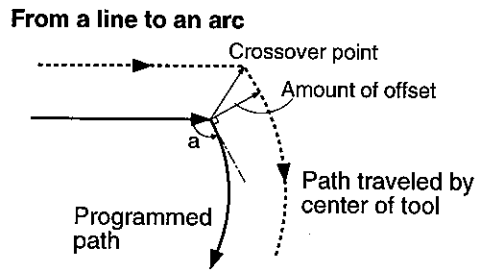
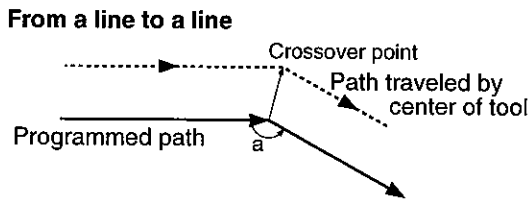

**Outer-side Acute Angle** ( $a < 90^\circ$ )

**From a line to a line**

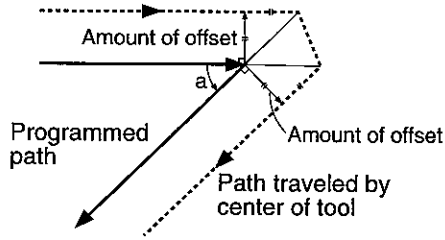

**From a line to an arc**

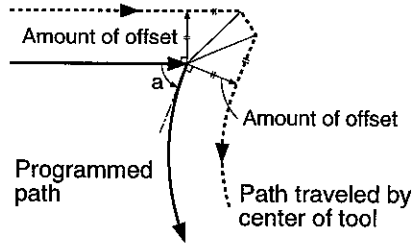

**From an arc to a line**

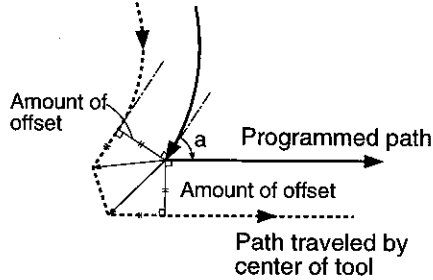

**From an arc to an arc**

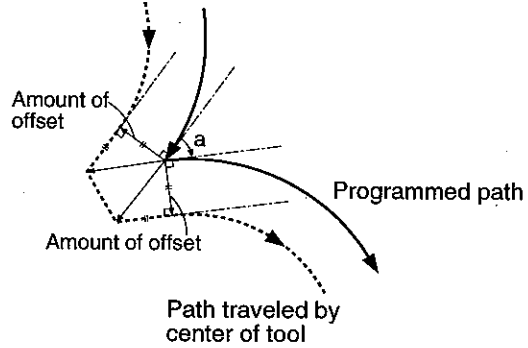

A case such as the following is an exception. In the figure at left, a crossover point exists on the path traveled by the tool center, and the tool path is created normally. When the amount of offset becomes larger, however, no crossover point exists on the tool-center path, as shown in the figure at right, and an error occurs.

**Exception**

**No crossover point on the tool path**

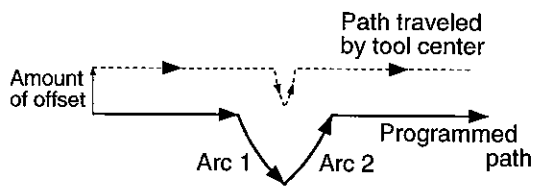

\* In this case, a crossover point exists on the tool-center path for arcs 1 and 2.

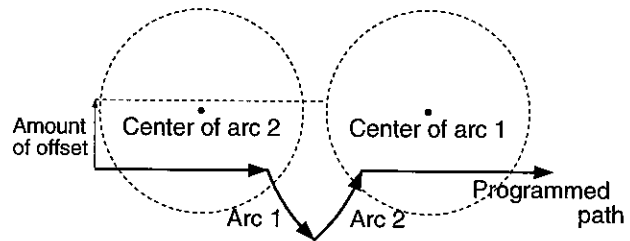

\* When the amount of offset becomes larger, the crossover point disappears from the tool-center path for arcs 1 and 2.

## Ending Cutter Compensation

Cutter compensation is ended with G40. A positioning (G00) specification is followed by G40. Cutter compensation cannot be ended by circular interpolation (G02 or G03).

As shown in the figure below (on the left-hand side), the tool is shifted to the left or the right by the amount of offset as it returns to the end point. Operation takes place when a command for moving to a block is specified when cutter compensation finishes.

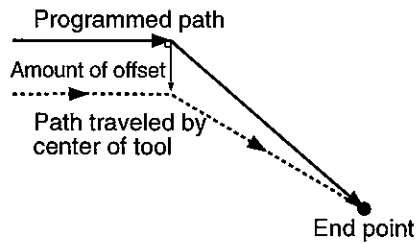

In the same way as when starting cutter compensation, outer-side travel includes Type A and Type B paths.

### Inner Side (180° ≤ a)

#### From a line to a line

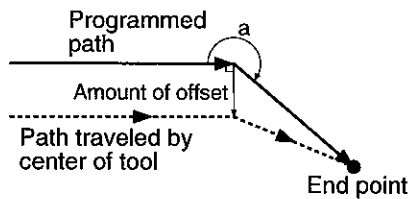

#### From an arc to a line

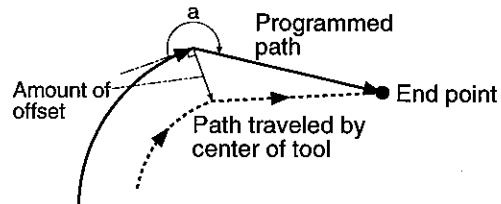

### Outer-side Obtuse Angle (90° ≤ a < 180°)

#### From a line to a line -- Type A

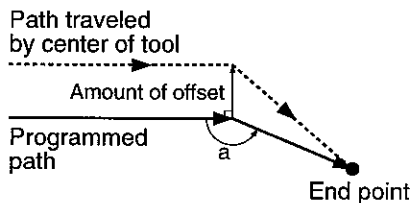

#### From a line to an arc -- Type A

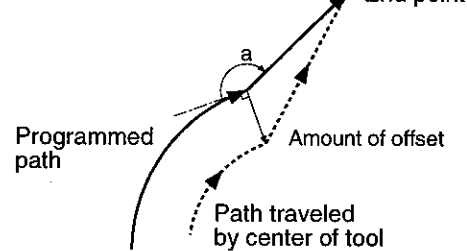

#### From a line to a line -- Type B

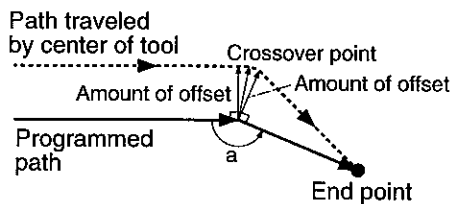

#### From a line to an arc -- Type B

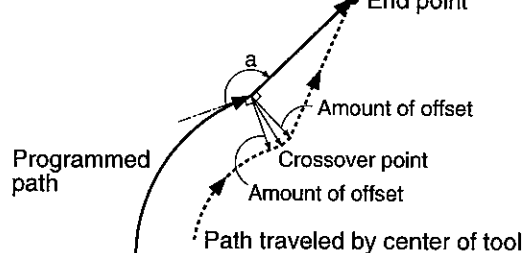

**Outer-side Acute Angle** ( $a < 90^\circ$ )

**From a line to a line -- Type A**

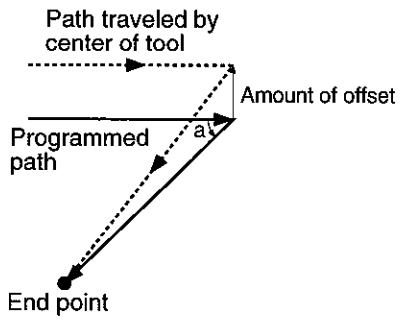

**From a line to an arc -- Type A**

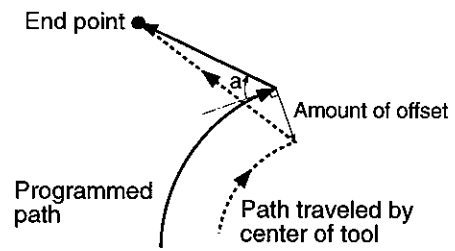

**From a line to a line -- Type B**

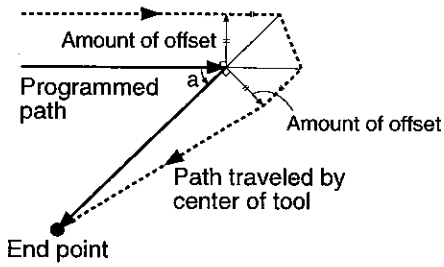

**From a line to an arc -- Type B**

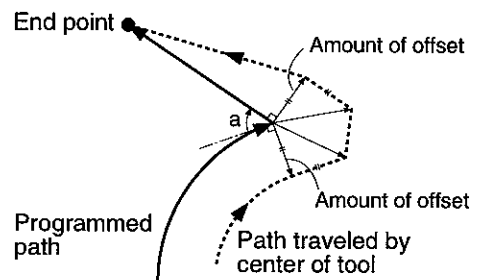

**Exceptions: Acute angles of  $1^\circ$  or less**

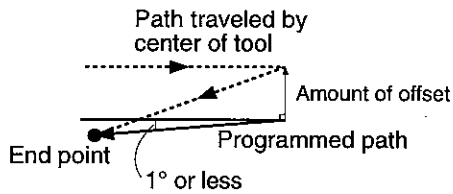

# G50 and G51

# Scaling

## Format

**G50**

**G51** [X *x*] [Y *y*] [Z *z*] [P *scale*]

Parameter	Function	Acceptable range	Effective range
<i>x</i>	Coordinate or movement distance (X axis)	Range 1	Maximum cutting range
<i>y</i>	Coordinate or movement distance (Y axis)	Range 1	Maximum cutting range
<i>z</i>	Coordinate or movement distance (Z axis)	Range 1	Maximum cutting range
<i>scale</i>	Scaling ratio	Range 2	0.00001 to 999.999

## Description

G51 executes equal enlargement or reduction for each axis, referenced to the specified point. It is used for such application as the creation of reduced-scale models. Because this instruction affects the entire program, G51 is normally specified immediately after the start of the program.

G50 cancels G51.

When enlargement or reduction has been specified with G51, it remains in effect until canceled with G50 or until another program is executed.

The reference point for enlargement or reduction is specified with the addresses X, Y, and Z. When not specified, the current tool position is used as the reference point.

*scale* is a numerical value specifying the ratio. Its effective range is a ratio of 0.00001 to a ratio of 999.999. A specified ratio less than 0.00001 is treated as a ratio of 0.00001, and a specified ratio larger than 999.999 is similarly taken to be a ratio of 999.999. When **P *scale*** is not specified, the settings made on the MDX-650/500 are used.

As an example, specifying a ratio of 0.5 produces the results shown below. If the length is a ratio of 0.5, the volume ratio becomes 0.125.

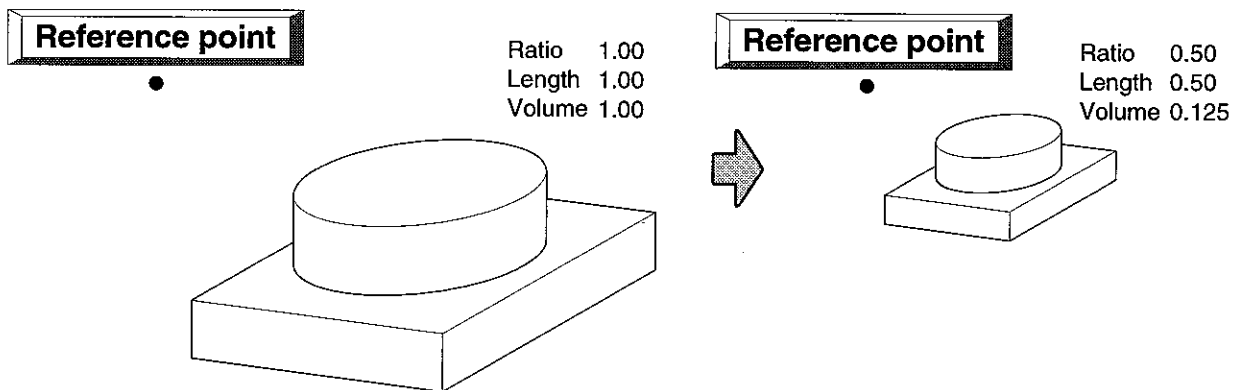



# G54, G55, G56, G57, G58 and G59

## Selects Coordinate System

### Format

G54  
G55  
G56  
G57  
G58  
G59

### Description

Up to six workpiece coordinate systems can be set, and any of the set coordinate systems can be selected by programming.

- G54:** Selects workpiece coordinate system 1
- G55:** Selects workpiece coordinate system 2
- G56:** Selects workpiece coordinate system 3
- G57:** Selects workpiece coordinate system 4
- G58:** Selects workpiece coordinate system 5
- G59:** Selects workpiece coordinate system 6

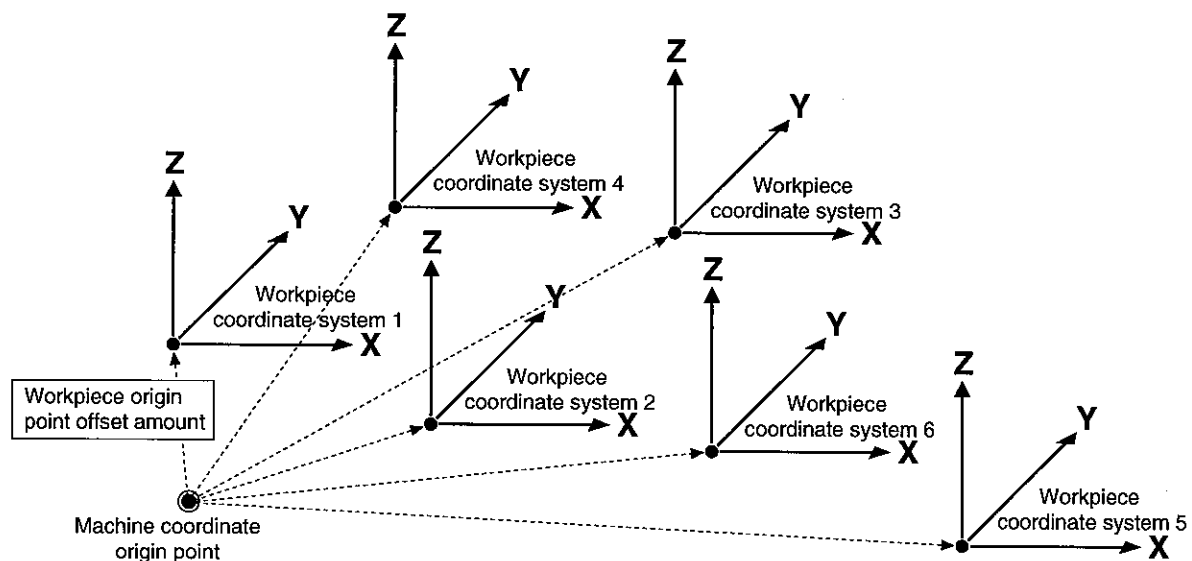

G54 through G59 are used to select workpiece coordinate systems which have been set in advance. Workpiece coordinate systems 1 through 6 are set using the display on the MDX-650/500. (Refer to the "User's Manual 3 Cutting Using NC-Codes" for an explanation of how to make the setting.)

Coordinate systems are described on "Part 1 Coordinate Systems".

**G80, G81, G82, G83, G85, G86 and G89**

**Fixed Cycle (Canned Cycle)**

**Format**

**G80**

- G98G81[X x ][Y y ][Z z ][R r ][K times ]
- G99G81[X x ][Y y ][Z z ][R r ][K times ]
- G98G82[X x ][Y y ][Z z ][R r ][P time ][K times ]
- G99G82[X x ][Y y ][Z z ][R r ][P time ][K times ]
- G98G83[X x ][Y y ][Z z ][R r ][Q q ][K times ]
- G99G83[X x ][Y y ][Z z ][R r ][Q q ][K times ]
- G98G85[X x ][Y y ][Z z ][R r ][K times ]
- G99G85[X x ][Y y ][Z z ][R r ][K times ]
- G98G86[X x ][Y y ][Z z ][R r ][K times ]
- G99G86[X x ][Y y ][Z z ][R r ][K times ]
- G98G89[X x ][Y y ][Z z ][R r ][P time ][K times ]
- G99G89[X x ][Y y ][Z z ][R r ][P time ][K times ]

Parameter	Function	Acceptable range	Effective range
x	Coordinate or movement distance (X axis)	Range 1	Maximum cutting range
y	Coordinate or movement distance (Y axis)	Range 1	Maximum cutting range
z	Coordinate or movement distance (Z axis)	Range 1	Maximum cutting range
r	Point R level (Z axis)	Range 1	Maximum cutting range
q	Cutting-in amount of each pass	Range 1	Maximum cutting range
time	Dwell time	Range 2	—
times	Number of repetitions	Range 1	0 to 9999

**Description**

A fixed (or canned) cycle is a command that executes a series of predetermined operations for cutting, such as for drilling a hole. This simplifies programming, because cutting operations spanning several blocks can be executed in a single block. The amount of data is also reduced.

G81, G82, G85, and G89 are fixed cycles for drilling. The functions of each of these words vary in terms of the feed rates between the specified points, and in the presence or absence of a dwell interval. G80 cancels a fixed cycle.

G98 and G99 specify the tool position (along the Z axis) after the completion of the fixed cycle. G98 specifies a return to the initial level, whereas G99 specifies return to the point R level. The initial level is the Z-axis tool position in effect before the fixed cycle was specified. The point R level is set between the Z-axis position on the surface of the workpiece and the initial level. Point R is specified in order to increase the tool movement distance at maximum speed and reduced the cutting time.

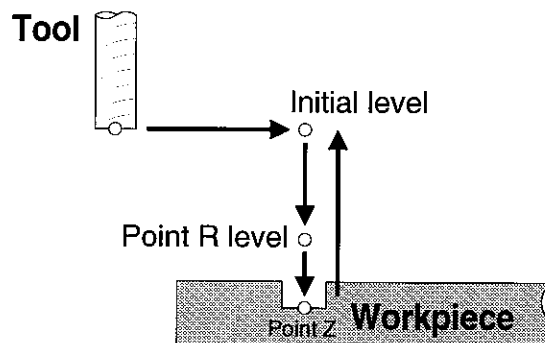

Cutting is performed at the spindle speed and feed rate that have been specified. Refer to "Feed Function (F Function)" for an explanation of the feed rate and to "Spindle Speed Function (SFunction)" for a description of spindle speed.

**X** *x* and **Y** *y* move the tool to the starting point. When not specified, drilling is carried out at the current tool position.  
**Z** *z* specifies the location of the bottom of the hole (along the Z axis). When not specified, no drilling is performed.  
**R** *r* specifies the point R level. This specifies the Z coordinate of point R for absolute programming and the distance from the initial level along the Z axis for incremental programming. When not specified, the same point as at the initial level is used.  
**P** *time* is specified for fixed cycles that include dwell (G82 and G89). A numerical value for the time interval is specified after P. The specified time is in seconds when a real number is used, and in milliseconds when an integer is used.

**P1000** 1-second dwell (units in milliseconds)

When not specified, there is no dwell.

**K** *times* specifies the number of repetitions. If programming is absolute, drilling is carried out as many times as specified at the same position. In incremental programming, drilling is carried out as many times as specified at equidistant points, as shown in the figure below. If **K** *times* is not specified, drilling is performed only once. The effective range is from 0 (no drilling) to 9,999 times. The operation is executed zero times if a number less than 0 (i.e., a negative number) is specified, and is executed 9,999 times if a number larger than 9,999 is specified.

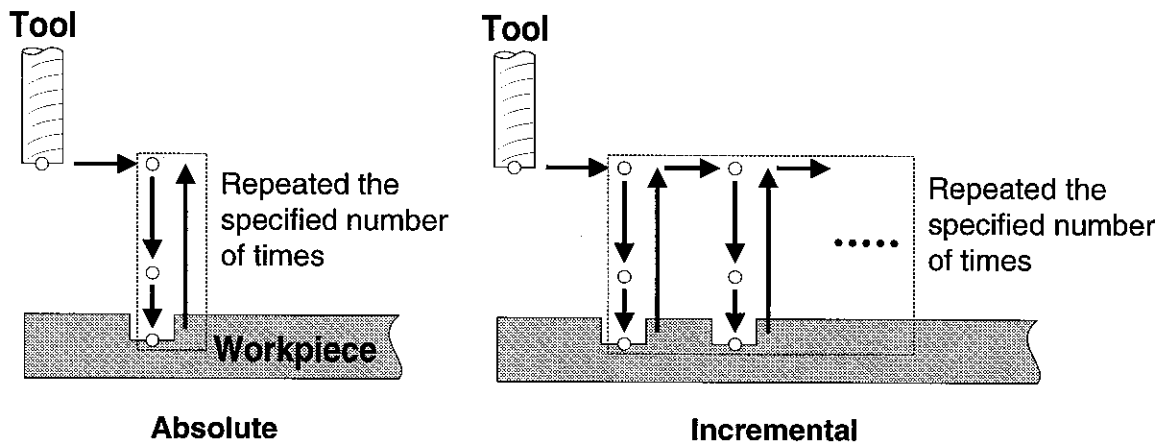

None of the fixed cycles includes the function for starting the spindle motor. If the spindle motor is not already turning, the M03 word should be given beforehand to start it. Executing a fixed cycle while the motor is not turning causes an error to be generated.

The following figures illustrate the specifications for each of the fixed cycles.

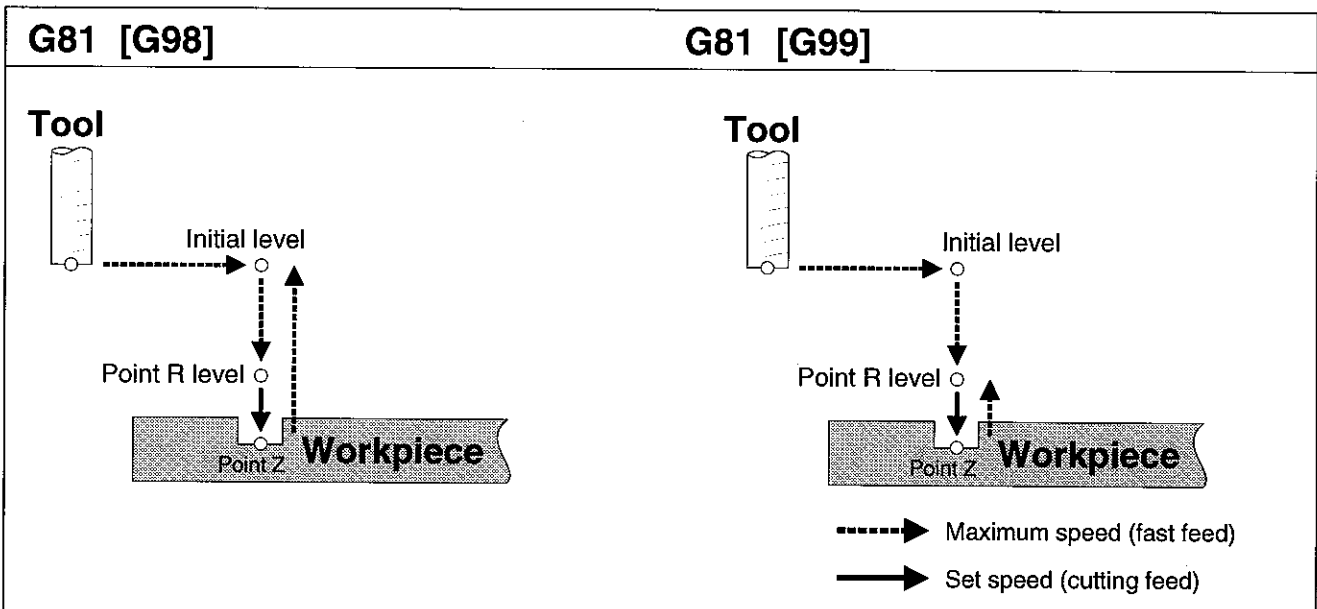

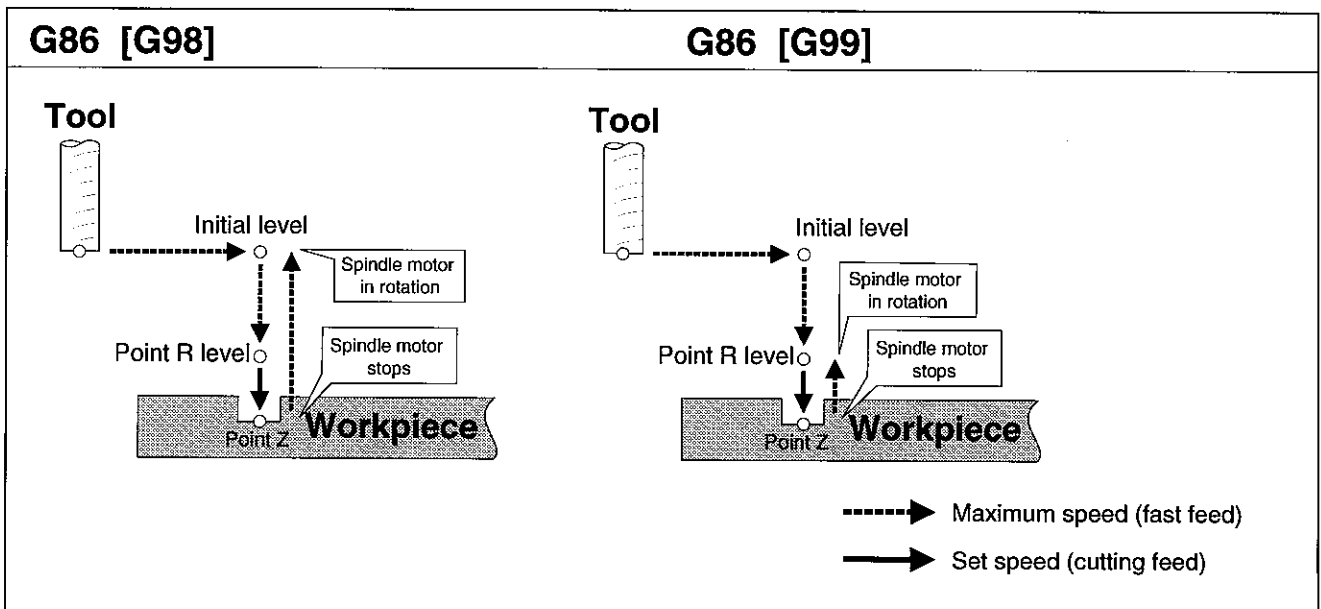
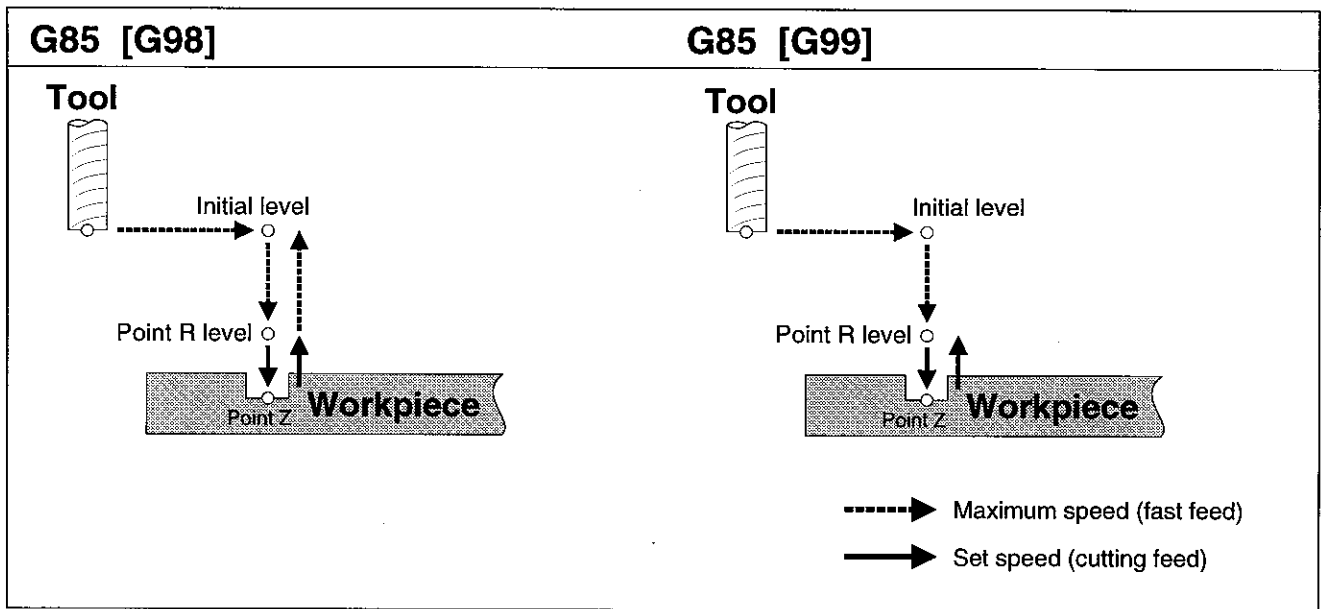
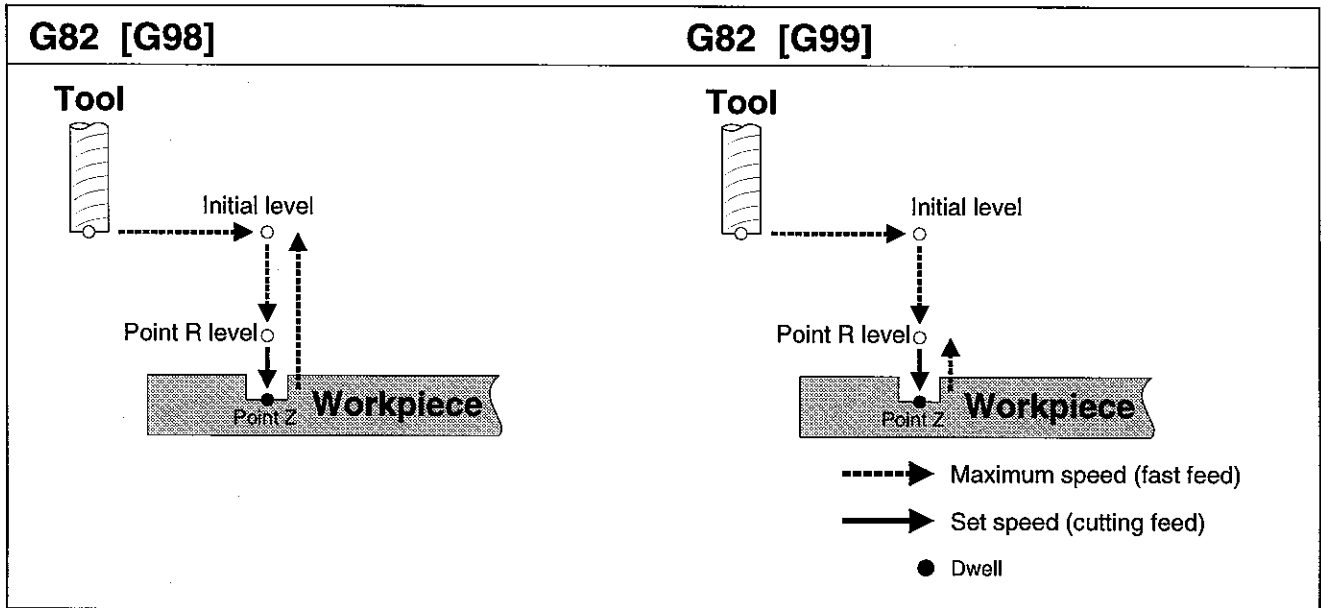

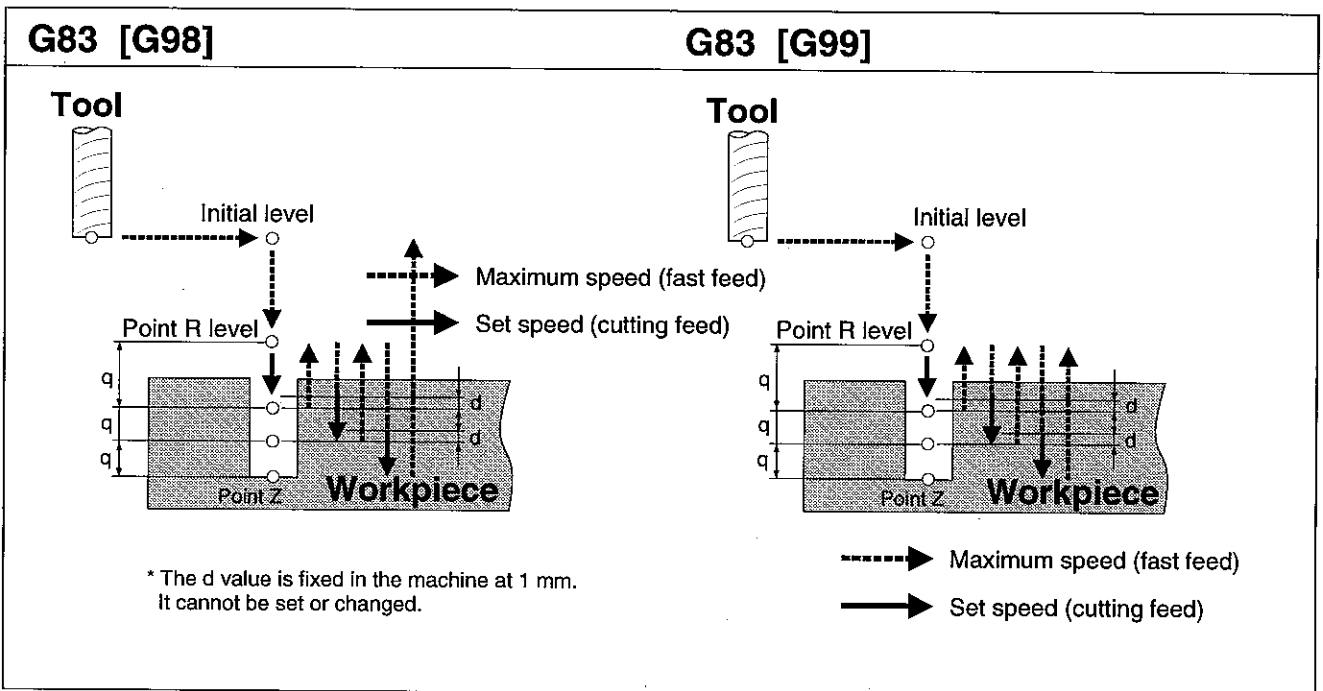
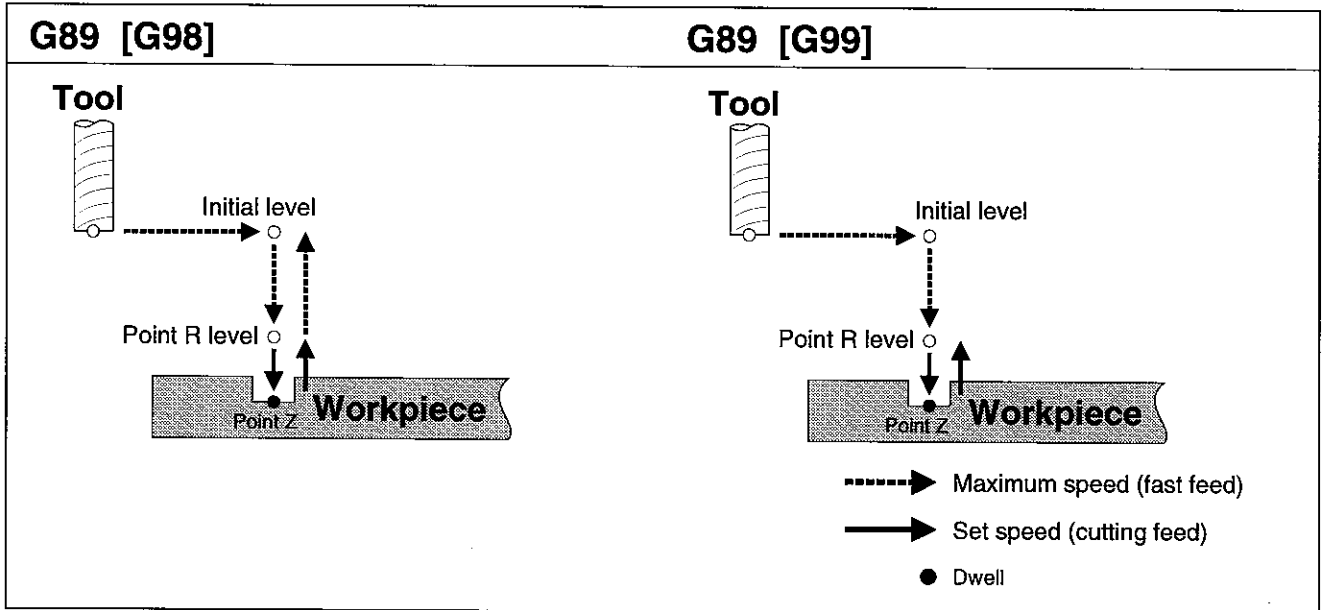

# G90 and G91

# Absolute and Incremental

## Format

G90

G91

## Description

There are two types of coordinate specifications: absolute and incremental.

The figure below shows the difference between absolute and incremental specifications on an X-Y plane. Absolute specifications indicate the position as the distance from the workpiece coordinate origin, whereas incremental specifications indicate the amount of movement from the current position.

Programming that specifies absolute coordinates is called "absolute programming," and programming which specifies incremental coordinates is termed "incremental programming."

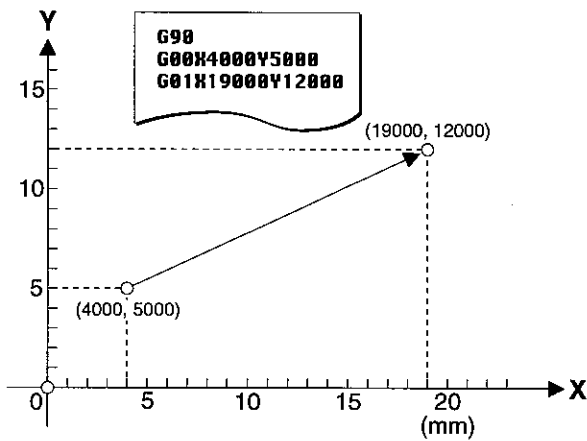

**Absolute**

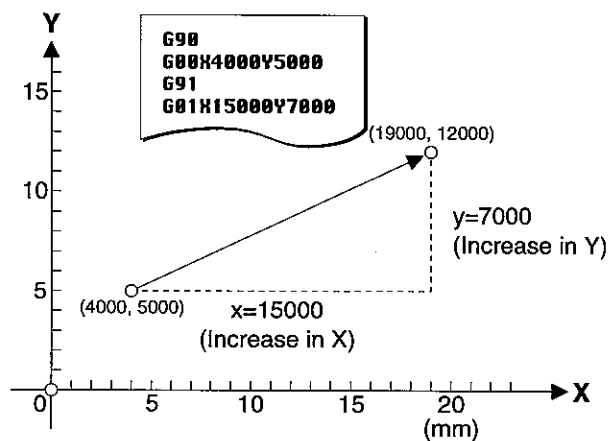

**Incremental**

The settings for G90 or G91 made on the MDX-650/500 remain in effect unless changed by programming.

There are no special rules for deciding when to use an absolute or incremental program. Examine the drawing and choose the one which makes for the simplest program.

**G92****Coordinate System****Format**

**G92**[X *x* ][Y *y* ][Z *z* ][A *a* ]

Parameter	Function	Acceptable range	Effective range
<i>x</i>	Workpiece coordinate (X axis)	Range 1	Maximum cutting range
<i>y</i>	Workpiece coordinate (Y axis)	Range 1	Maximum cutting range
<i>z</i>	Workpiece coordinate (Z axis)	Range 1	Maximum cutting range
<i>a</i>	Workpiece coordinate (A axis)	Range 1	Maximum cutting range

**Description**

This sets the present position of the tool to the specified workpiece coordinate.

This word is used to operate the machine to move the tool to a certain point on the workpiece and set the workpiece coordinate for that point. This changes the origin point for the workpiece coordinate system. Refer to "Part 1\_Coordinate Systems" for an explanation of workpiece coordinate systems.

G92 is a code effective only within the block. For this reason, only coordinate values specified in the same block as G92 are interpreted as the set workpiece coordinates.

In general, the workpiece coordinate origin is not changed during the course of program execution. Consequently, this word is used at the start of a program.

Executing **G92H20.0Y15.0Z10.0** sets the coordinate system taking this as the origin point.

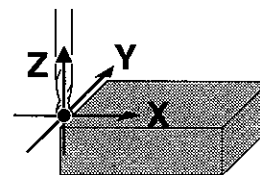
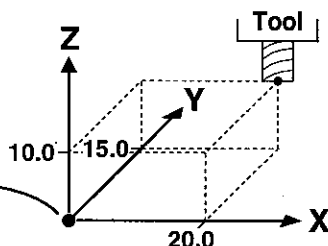

**G98****Initial Level Return****Format**

G98

**Description**

This specifies the tool position (along the Z axis) after the completion of a fixed cycle. G98 specifies a return to the initial level. The initial level is the Z-axis tool position in effect before the fixed cycle was specified. See "Fixed Cycle (Canned Cycle) G80, G81, G82, G83, G85, G86 and G89" for an explanation of fixed cycles.

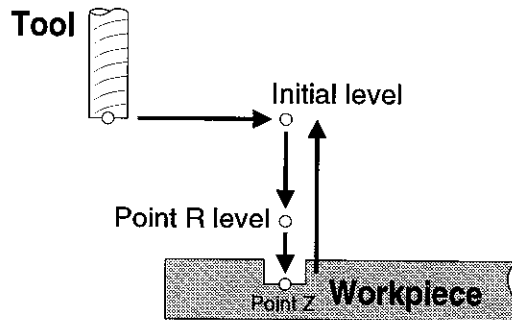
**G99****Point R Level Return****Format**

G99

**Description**

This specifies the tool position (along the Z axis) after the completion of a fixed cycle. G99 specifies return to the point R level. The point R level is set between the Z-axis position on the surface of the workpiece and the initial level. Point R is specified in order to increase the tool movement distance at maximum speed and reduced the cutting time. Refer to "Fixed Cycle (Canned Cycle) G80, G81, G82, G83, G85, G86 and G89" for an explanation of fixed cycles.

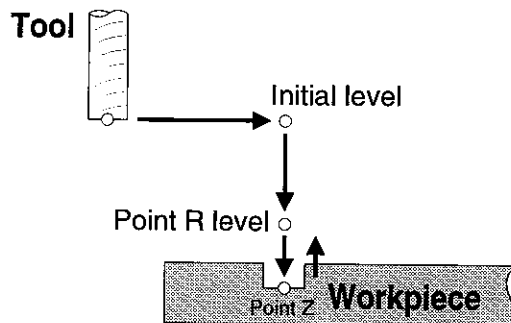



# [ Miscellaneous Functions (M Functions) ]

## ***M00***

## ***Program Stop***

### **Format**

**M00**

### **Description**

After the operations specified within the block have been completed, the spindle motor stops. The state of the spindle motor (rotating or stopped) does not change.

## ***M01***

## ***Optional Stop***

### **Format**

**M01**

### **Description**

In the same way as for M00, a stop takes place after the operations specified within the block have been completed. The state of the spindle motor (rotating or stopped) does not change.

## ***M02***

## ***End of Program***

### **Format**

**M02**

### **Description**

This indicates that the main program has ended.

## ***M03 and M05***

## ***Spindle Motor Start/Stop***

### **Format**

**M03**

**M05**

### **Description**

M03 instructs the machine to start the spindle motor, and M05 instructs the machine to stop it.

M03 is the only instruction that is available to start the spindle motor. Cutting instructions such as G01, G02, and G03 do not include the function for starting the spindle motor, so M03 must be given to start the motor before any cutting instruction is input to the machine.

If the motor is already turning, M03 is ignored and the motor continues to turn. Similarly, M05 is ignored if the motor is already stopped, and the motor remains stopped.

**M30****End of Program****Format****M30****Description**

This instructs the main program to end.

**M98****Subprogram Call****Format**

**M98 P** *times number* [When four-digit program numbers have been specified]

**M98 P** *number* [When eight-digit program numbers have been specified]

Parameter	Function	Acceptable range	Effective range
<i>times</i>	Number of calls	1–9999	1–9999
<i>number</i>	Program number	0001–9999 (four digits)	0001–9999 (four digits)
		00000001–99999999 (eight digits)	00000001–99999999 (eight digits)

**Description**

The subprogram of the specified number is called up and executed. A subprogram call can be made not only from a main program, but from another subprogram as well. However, attempting to call another subprogram from a fourth-level subprogram of a main program causes an error to be generated.

The *times* parameter specifies the number of times a subprogram is called, and it can be entered only when four-digit program numbers have been specified. The subprogram is called and executed the number of times specified by this parameter. When *times* is not specified, the subprogram is called once.

When eight-digit program numbers have been specified, nothing can be entered, and the number of calls is always fixed.

The *number* parameter indicates the program number of the subprogram. Be sure to specify a four-digit program number when four-digit program numbers have been specified, or an eight-digit program number when eight-digit program numbers have been specified. For example, if the program number is 2, specify “0002” when four-digit program numbers have been specified, or “00000002” when eight-digit program numbers have been specified. If a program of the specified number does not exist, an error is generated.

The number of digits employed to specify numbers is set before sending on the MDX-650/500. For more information on how to make the setting, refer to “User’s Manual 3 — Cutting Using NC Codes.”

Continued on the next page

**\* About Differences in How Four-digit and Eight-digit Specifications Are Interpreted**

Depending on the settings on the MDX-650/500, the program content may be interpreted differently, as shown in the following examples.

For this reason, programs with different specifications for the number of digits cannot be used together.

**M98P12345678**

Set to "8 digits": The subprogram with the program number "12345678" is called.

Set to "4 digits": The subprogram with the program number "5678" is called 1234 times.

[ When four-digit program numbers are specified ]

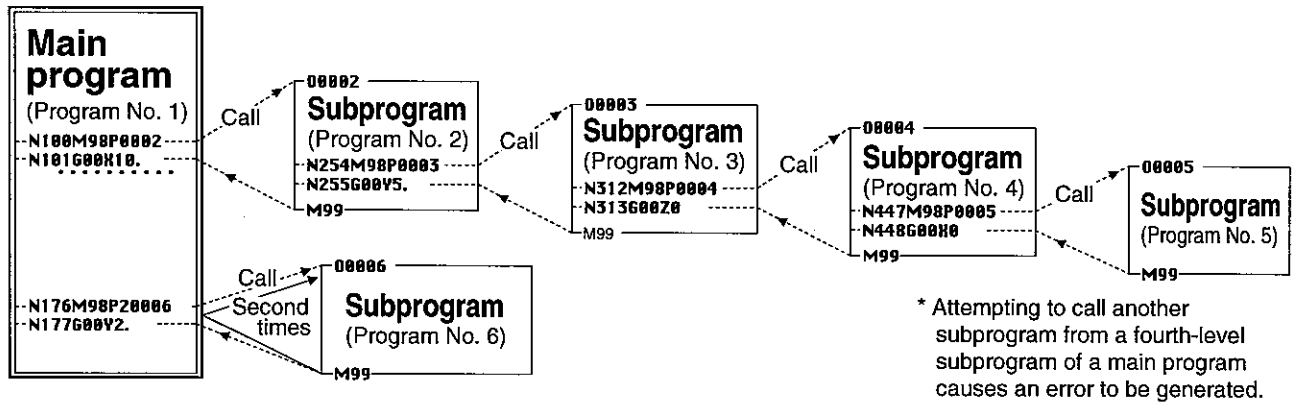

[ When eight-digit program numbers are specified ]

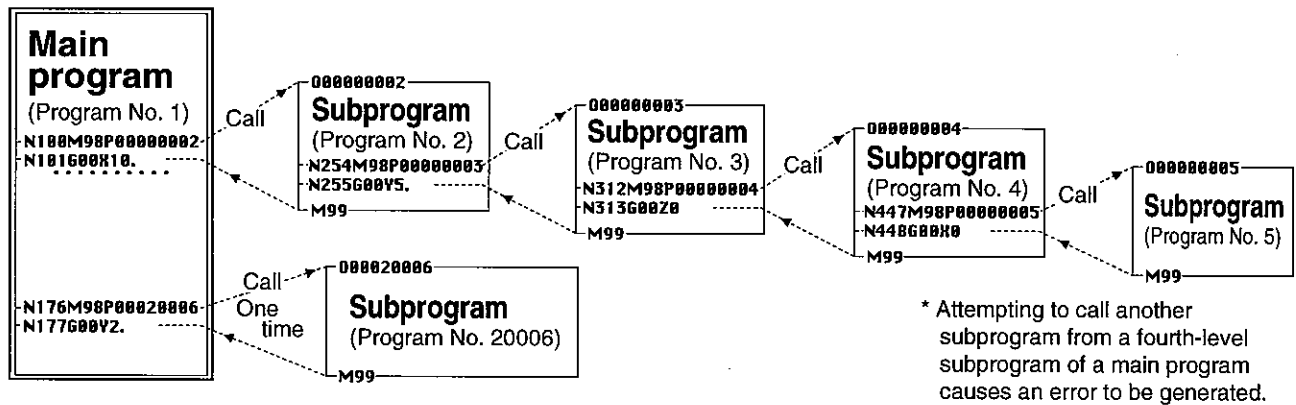

# M99

# End of Subprogram

## Format

M99

## Description

This indicates the end of a subprogram. Execution returns to the code after the call source (M98).

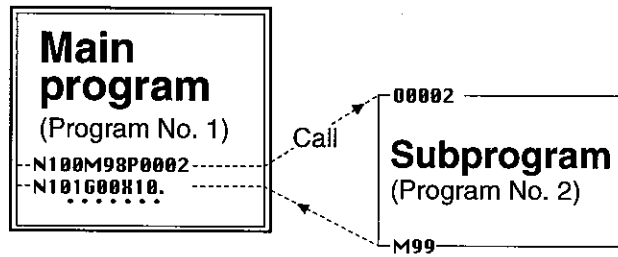

# [ Spindle Speed Function (S Function) ]

This specifies the speed of the spindle motor.

The S function does not include a function for starting the spindle motor. It is effective only when the spindle has been started with M03 or is otherwise already turning.

## Format

*S revolution speed*

Parameter	Function	Acceptable range	Effective range
<i>revolution speed</i>	Spindle speed	-65535 to 65535	Specifying the speed (in rpm) When [SPINDLE UNIT] is set to [HIGH TORQUE] : 3000 to 12000 When [SPINDLE UNIT] is set to [HIGH SPEED] : 5000 to 20000 Numerical code specification : 70 to 86

## Description

If specified when the spindle motor is already rotating, the operation is performed simultaneously with the specification. If specified when the spindle motor is stopped, the speed specified by the S function is enabled when M03 is given.

A numerical value for the speed is specified following S. The rotation speed may be specified as rpm or through the speed code specification.

## Specifying the speed (in rpm)

This method specifies the speed in units of rpm (revolutions per minute).

If the specified speed exceeds the maximum speed, the maximum speed is set. Similarly, the minimum speed is set if the specified speed is less than the minimum speed.

## Numerical code specification

With this method, speeds are pre-assigned to numerical codes from 01 to 99, and these numerical codes are specified to set the desired speed.

If the specified speed exceeds the maximum speed, the maximum speed is set. Similarly, the minimum speed is set if the specified speed is less than the minimum speed.

If a value of 0 (zero) is specified, the minimum speed is set.

If a real number is specified, any value to the right of the decimal point is truncated.

The speeds assigned to the numerical codes are shown in the table on the following page.

Part 2 Reference

Code	Spindle speed (rpm)	Code	Spindle speed (rpm)	Code	Spindle speed (rpm)	Code	Spindle speed (rpm)	Code	Spindle speed (rpm)
00	* (1)	20	10.0	40	100	60	1000	80	10000
01	1.12	21	11.2	41	112	61	1120	81	11200
02	1.25	22	12.5	42	125	62	1250	82	12500
03	1.40	23	14.0	43	140	63	1400	83	14000
04	1.60	24	16.0	44	160	64	1600	84	16000
05	1.80	25	18.0	45	180	65	1800	85	18000
06	2.00	26	20.0	46	200	66	2000	86	20000
07	2.24	27	22.4	47	224	67	2240	87	22400
08	2.50	28	25.0	48	250	68	2500	88	25000
09	2.80	29	28.0	49	280	69	2800	89	28000
10	3.15	30	31.5	50	315	70	3150	90	31500
11	3.55	31	35.5	51	355	71	3550	91	35500
12	4.00	32	40.0	52	400	72	4000	92	40000
13	4.50	33	45.0	53	450	73	4500	93	45000
14	5.00	34	50.0	54	500	74	5000	94	50000
15	5.60	35	56.0	55	560	75	5600	95	56000
16	6.30	36	63.0	56	630	76	6300	96	63000
17	7.10	37	71.0	57	710	77	7100	97	71000
18	8.00	38	80.0	58	800	78	8000	98	80000
19	9.00	39	90.0	59	900	79	9000	99	* (2)

- \* (1): Minimum spindle motor speed
- \* (2): Maximum spindle motor speed
- : Effective range of operation for MDX-650/500

# [ Feed Functions (F Functions) ]

This determines the feed rate for the workpiece and the spindle.

The feed rate generally varies according to the cutting parameters (such as the spindle speed, tool diameter, and workpiece material).

## Format

F *feed rate*

Parameter	Function	Acceptable range	Effective range
<i>feed rate</i>	Feed rate	Range 1	0 to 5100 [mm/min.] 0 to 200.78 [inch/min.]

## Description

The feed rate is specified as a real or integer value following the "F."

When an F function is specified, the operation is performed simultaneously with the specification.

For millimeter input

**F120.0** Feed rate set at 120 mm/min.

**F120000** Feed rate set at 120 mm/min. (in 0.001 mm/min. units)

For inch input

**F5.0** Feed rate set at 5 inch/min.

**F50000** Feed rate set at 5 inch/min. (in 0.0001 inch/min. units)

If a speed exceeding the maximum speed is specified, the maximum speed is set. In the same way, the minimum speed is set if the specified speed is less than the minimum speed.

The feed rate which is actually used is determined in a stepwise manner on the MDX-650/500. The actual feed rate is either 0.5 mm/sec., or from 1 to 85 mm/sec. (in steps of 1 mm/sec.). The equivalent per-minute speeds are 30 mm/min. and from 60 to 5,100 mm/min. (in steps of 60 mm/min.).

When the *feed rate* parameter is set to 0, operation is at a speed of 30 mm/min.

The specified value is rounded down to the nearest multiple of 60.

Examples:

Command	Operating speed (mm/min.)
<b>F70.0</b>	60
<b>F119.0</b>	60
<b>F120.0</b>	120

Operation is similar for inch input, except that the millimeter values are converted to inches.

When rotation of the rotation axis (axis A) is also performed, the rotation speed changes according to the present tool position and the distance of the center of rotation. For example, loading a workpiece having a diameter of 200 mm on the rotary axis unit and specifying "F300.0" when the tool tip is at the workpiece surface, the cutting speed is set so as to cut the workpiece surface at 300 mm/min. However, if instructions are given to perform rotation simultaneously with raising or lowering the tool, the speed of rotation does not change during tool movement, and so there is a chance that the cutting speed may change suddenly. At such times, we recommend setting a slower feed rate in advance.

# [ Other Functions ]

## N *Sequence Number*

### Format

N *number*

Parameter	Function	Acceptable range	Effective range
<i>number</i>	Sequence number	1 to 9999 (four digits)	1 to 9999 (four digits)
		1 to 99999999 (eight digits)	1 to 99999999 (eight digits)

### Description

A sequence number is an integer number for a block. It is specified at the start of the block. A sequence number may either be present or absent from any or all blocks. There is also no need for sequence numbers to be consecutive, or to be arranged in order from smaller to larger numbers. However, consecutive sequence numbers are customarily used to mark critical places within a program. For *number*, enter a four-digit integer value (1 to 9999) or an eight-digit integer value (1 to 99999999). The number of digits employed to specify numbers is set before sending on the MDX-650/500. For more information on how to make the setting, refer to "User's Manual 3 — Cutting Using NC Codes."

## O *Program Number*

### Format

O *number*

Parameter	Function	Acceptable range	Effective range
<i>number</i>	Program number	1 to 9999 (four digits)	1 to 9999 (four digits)
		1 to 99999999 (eight digits)	1 to 99999999 (eight digits)

### Description

Program numbers are sequential numbers for programs. A program begins with a program number and ends with either M02, M30, or M99. The program number is specified at the start of a program.

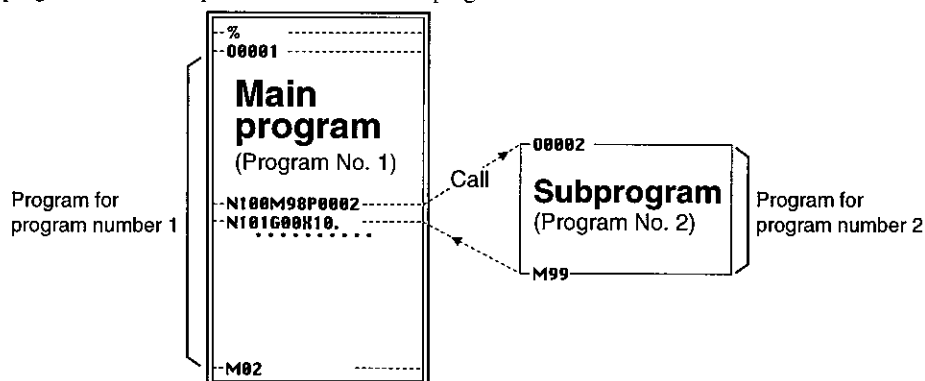

The number parameter is a program number, and is entered as an integer value of four digits (1 to 9999) or eight digits (1 to 99999999). Normally, you should specify the number of digits that is employed for specifying program numbers. (For example, if the program number is 2, specify "0002" when four-digit program numbers have been specified, or "00000002" when eight-digit program numbers have been specified.) You cannot enter "0" (0000 or 00000000) for a program number. Be careful to ensure that there are no duplicate program numbers or program numbers with different numbers of digits within a single program. A program number can be used to call a subprogram. The number of digits employed to specify numbers is set before sending on the MDX-650/500. For more information on how to make the setting, refer to "User's Manual 3 — Cutting Using NC Codes."



/

**Optional Block Skip****Format**

/

**Description**

This function makes it possible to skip over a desired block within a program. Optional block skip is specified at the start of the block.

```

.....
.....
G01Z-7.0
G01Y35.0
/M98P0002          ← Subprogram call is skipped (not called)
G03X15.0Y-15.0I15.0
.....
.....

```

Enter a "/" (slash) at the start of the block.

The setting for enabling or disabling block skip is made on the MDX-650/500. (Refer to "User's Manual 3 -- Cutting Using NC Codes.")

% or **ER****Program Start****Format**

```

%      (ISO or ASCII code)
or
ER   (EIA code)

```

**Description**

A block containing only a "%" must appear at the start of the data. No other word should be specified within a block in which "%" or "**ER**" is specified. This notifies the machine of the start of the data. When it is present at the end of the data, its effect varies according to the data-transmission method. The data start character is "%" if ISO or ASCII is in use as the character code system, of "**ER**" if EIA is in use.

Be sure to specify either "%" or "**ER**" at the beginning of the program and subprogram. All programs and subprograms are ignored until the data start is specified.

**EOB**

**End of Block**

**Description**

A program is a series of instructions (written commands) for the machine, expressed as symbols and numbers. These instructions are separated by **EOB** markers, with the information between two **EOB** markers forming one instruction. This single instruction between two **EOB** markers is called a block. Each block, in turn, is composed of words.

The character code systems supported by the machine are ASCII, ISO, and EIA. Each character of ASCII data has a length of 7 bits, whereas ISO and EIA characters are each 8 bits in length. The **EOB** marker differs according the code system. ASCII uses **LF** (line feed), or **NL** (new line). ISO uses **LF**, and EIA uses **CR** (carriage return).

Refer to "Character Code Table (ISO, EIA, and ASCII)" for a table of the character code systems. The character code system is selected from the machine. Refer to the User's Manual 3 Cutting Using NC-Codes for a description of the setting procedure.

**()**

**Comment**

**Format**

*( message )*

Parameter	Function	Acceptable range	Effective range
<i>message</i>	Comment (text string)	—	—

**Description**

Comments can be included within a program.

A text string appearing between a "(" and ")" is considered to be a comment and is skipped over during program execution. Comments can be useful for noting a program's revision history, describing the content of a program, indicating cautions regarding cutting time, and so on.

There is no restriction on the number of characters which a comment may contain.

```

%
G90
O0001
(,main program start)          ← This is a comment.
G00Z5.0
.....
.....
    
```

# Appendices

## Words Table

### Preparatory Functions (G Functions)

	Functions	Group (*)	Effective only within the block in which specified
<b>G 00</b>	Positioning	a	
<b>G 01</b>	Linear interpolation		
<b>G 02</b>	Clockwise circular interpolation		
<b>G 03</b>	Counterclockwise circular interpolation		
<b>G 04</b>	Dwell		○
<b>G 10</b>	Data setting		○
<b>G 17</b>	Specifies the X-Y plane	b	
<b>G 18</b>	Specifies the Z-X plane		
<b>G 19</b>	Specifies the Y-Z plane		
<b>G 20</b>	Inch input	c	
<b>G 21</b>	Millimeter input		
<b>G 39</b>	Corner-offset circular interpolation		○
<b>G 40</b>	Cancel cutter compensation	d	
<b>G 41</b>	Cutter compensation — left		
<b>G 42</b>	Cutter compensation — right		
<b>G 50</b>	Cancel scaling	e	
<b>G 51</b>	Scaling		
<b>G 54</b>	Selects workpiece coordinate system 1	f	
<b>G 55</b>	Selects workpiece coordinate system 2		
<b>G 56</b>	Selects workpiece coordinate system 3		
<b>G 57</b>	Selects workpiece coordinate system 4	g	
<b>G 58</b>	Selects workpiece coordinate system 5		
<b>G 59</b>	Selects workpiece coordinate system 6		
<b>G 80</b>	Cancel fixed cycle		
<b>G 81</b>	Fixed cycle		
<b>G 82</b>	Fixed cycle		
<b>G 83</b>	Fixed cycle		
<b>G 85</b>	Fixed cycle		
<b>G 86</b>	Fixed cycle		
<b>G 89</b>	Fixed cycle		
<b>G 90</b>	Absolute specifications	h	
<b>G 91</b>	Incremental specifications		
<b>G 92</b>	Coordinate system		○
<b>G 98</b>	Initial level return	i	
<b>G 99</b>	Point R level return		

The group indications "a" through "i" signify that the respective functions belong to the same group.

\* Maintained until another command is encountered in the same group.

### Miscellaneous Functions (M Functions)

Code	Functions	Function start	Function continue	
		Functions when specified	Maintained until canceled or changed	Effective only within the block in which specified
M 00	Program stop	○		○
M 01	Optional stop	○		○
M 02	End of program	○		○
M 03	Spindle start	○	○	
M 05	Spindle stop	○	○	
M 30	End of program	○		○
M 98	Subprogram Call	○		○
M 99	End of subprogram	○		○

M00, M01, M02, M30, M98, M99 should be specified in a discrete block.  
Do not include any other words or code in the block containing these.

### Spindle speed Functions (S Functions)

The operation is performed simultaneously with the specification.

### Feed Functions (F Functions)

The operation is performed simultaneously with the specification.

# Character Code Table (ISO, EIA, and ASCII)

Meaning	ISO			EIA			ASCII		
	Character	Hexadecimal	Decimal	Character	Hexadecimal	Decimal	Character	Hexadecimal	Decimal
Numeral 0	<b>0</b>	30	48	<b>0</b>	20	32	<b>0</b>	30	48
Numeral 1	<b>1</b>	B1	177	<b>1</b>	01	1	<b>1</b>	31	49
Numeral 2	<b>2</b>	B2	178	<b>2</b>	02	2	<b>2</b>	32	50
Numeral 3	<b>3</b>	33	51	<b>3</b>	13	19	<b>3</b>	33	51
Numeral 4	<b>4</b>	B4	180	<b>4</b>	04	4	<b>4</b>	34	52
Numeral 5	<b>5</b>	35	53	<b>5</b>	15	21	<b>5</b>	35	53
Numeral 6	<b>6</b>	36	54	<b>6</b>	16	22	<b>6</b>	36	54
Numeral 7	<b>7</b>	B7	183	<b>7</b>	07	7	<b>7</b>	37	55
Numeral 8	<b>8</b>	B8	184	<b>8</b>	08	8	<b>8</b>	38	56
Numeral 9	<b>9</b>	39	57	<b>9</b>	19	25	<b>9</b>	39	57
Address A	<b>A</b>	41	65	<b>a</b>	61	97	<b>A</b>	41	65
Address B	<b>B</b>	42	66	<b>b</b>	62	98	<b>B</b>	42	66
Address C	<b>C</b>	C3	195	<b>c</b>	73	115	<b>C</b>	43	67
Address D	<b>D</b>	44	68	<b>d</b>	64	100	<b>D</b>	44	68
Address E	<b>E</b>	C5	197	<b>e</b>	75	117	<b>E</b>	45	69
Address F	<b>F</b>	C6	198	<b>f</b>	76	118	<b>F</b>	46	70
Address G	<b>G</b>	47	71	<b>g</b>	67	103	<b>G</b>	47	71
Address H	<b>H</b>	48	72	<b>h</b>	68	104	<b>H</b>	48	72
Address I	<b>I</b>	C9	201	<b>i</b>	79	121	<b>I</b>	49	73
Address J	<b>J</b>	CA	202	<b>j</b>	51	81	<b>J</b>	4A	74
Address K	<b>K</b>	4B	75	<b>k</b>	52	82	<b>K</b>	4B	75
Address L	<b>L</b>	CC	204	<b>l</b>	43	67	<b>L</b>	4C	76
Address M	<b>M</b>	4D	77	<b>m</b>	54	84	<b>M</b>	4D	77
Address M	<b>N</b>	4E	78	<b>n</b>	45	69	<b>N</b>	4E	78
Address O	<b>O</b>	CF	207	<b>o</b>	46	70	<b>O</b>	4F	79
Address P	<b>P</b>	50	80	<b>p</b>	57	87	<b>P</b>	50	80
Address Q	<b>Q</b>	D1	209	<b>q</b>	58	88	<b>Q</b>	51	81
Address R	<b>R</b>	D2	210	<b>r</b>	49	73	<b>R</b>	52	82
Address S	<b>S</b>	53	83	<b>s</b>	32	50	<b>S</b>	53	83
Address T	<b>T</b>	D4	212	<b>t</b>	23	35	<b>T</b>	54	84
Address U	<b>U</b>	55	85	<b>u</b>	34	52	<b>U</b>	55	85
Address V	<b>V</b>	56	86	<b>v</b>	25	37	<b>V</b>	56	86
Address W	<b>W</b>	D7	215	<b>w</b>	26	38	<b>W</b>	57	87
Address X	<b>X</b>	D8	216	<b>x</b>	37	55	<b>X</b>	58	88
Address Y	<b>Y</b>	59	89	<b>y</b>	38	56	<b>Y</b>	59	89
Address Z	<b>Z</b>	5A	90	<b>z</b>	29	41	<b>Z</b>	5A	90
Delete	<b>DEL</b>	FF	255	<b>Del</b>	7F	127	<b>DEL</b>	7F	127
Back Space	<b>BS</b>	88	136	<b>BS</b>	2A	42	<b>BS</b>	08	8
Tab	<b>HT</b>	09	9	<b>Tab</b>	3E	62	<b>HT</b>	09	9
End of Block	<b>LF or NL</b>	0A	10	<b>CR</b>	80	128	<b>LF</b>	0A	10
Carriage Return	<b>CR</b>	8D	141				<b>CR</b>	0D	13
Space	<b>SP</b>	A0	160	<b>SP</b>	10	16	<b>SP</b>	20	32
Program Start	<b>%</b>	A5	165	<b>ER</b>	0B	11	<b>%</b>	25	37

## MEMO



