

# PICZA

## **3D LASER SCANNER**

# LPX-250

## USER'S MANUAL

Thank you very much for purchasing the LPX-250.

- To ensure correct and safe usage with a full understanding of this product's performance, please be sure to read through this manual completely and store it in a safe location.
- Unauthorized copying or transferral, in whole or in part, of this manual is prohibited.
- The contents of this operation manual and the specifications of this product are subject to change without notice.
- The operation manual and the product have been prepared and tested as much as possible. If you find any misprint or error, please inform us.
- Roland DG Corp. assumes no responsibility for any direct or indirect loss or damage which may occur through use of this product, regardless of any failure to perform on the part of this product.
- Roland DG Corp. assumes no responsibility for any direct or indirect loss or damage which may occur with respect to any article made using this product.



CLASS 1 LASER PRODUCT

**For the USA**

**FEDERAL COMMUNICATIONS COMMISSION  
RADIO FREQUENCY INTERFERENCE  
STATEMENT**

This equipment has been tested and found to comply with the limits for a Class A digital device, pursuant to Part 15 of the FCC Rules.

These limits are designed to provide reasonable protection against harmful interference when the equipment is operated in a commercial environment.

This equipment generates, uses, and can radiate radio frequency energy and, if not installed and used in accordance with the instruction manual, may cause harmful interference to radio communications.

Operation of this equipment in a residential area is likely to cause harmful interference in which case the user will be required to correct the interference at his own expense.

Unauthorized changes or modification to this system can void the users authority to operate this equipment.

The I/O cables between this equipment and the computing device must be shielded.

**For Canada**

**CLASS A NOTICE**

This Class A digital apparatus meets all requirements of the Canadian Interference-Causing Equipment Regulations.

**CLASSE A AVIS**

Cet appareil numérique de la classe A respecte toutes les exigences du Règlement sur le matériel brouilleur du Canada.



**ROLAND DG CORPORATION**

**1-6-4 Shinmiyakoda, Hamamatsu-shi, Shizuoka-ken, JAPAN 431-2103**

**MODEL NAME** : See the MODEL given on the rating plate.

**RELEVANT DIRECTIVE** : **EC LOW VOLTAGE DIRECTIVE (73/23/EEC)**

**EC ELECTROMAGNETIC COMPATIBILITY DIRECTIVE (89/336/EEC)**

This system (including the housing and safety device) is a Class 1 laser product. However, the laser light emitted internally is Class 2. Laser specifications of this system (including the housing)

Wavelength: 600 to 700 nm, maximum output: 0.39  $\mu$ W, pulse width 350  $\mu$ s, pulse frequency: 2,875 Hz

This product complied with 21 CFR Chapter I Subchapter J  
Complied with IEC Publication 60825-1, Amendment 1, 1997

**CAUTION**



Use of controls or adjustments or performance of procedures other than those specified herein may result in radiation exposure.

# To Ensure Safe Use





Please read this document completely before operating the machine. It contains safety cautions and information essential in assuring safe operation. Observe all cautions in operation.

Cautions related to the safe operation of this machine are indicated as shown below.

## About ⚠ WARNING and ⚠ CAUTION Notices

 <b>WARNING</b>	Used for instructions intended to alert the user to the risk of death or severe injury should the unit be used improperly.
 <b>CAUTION</b>	Used for instructions intended to alert the user to the risk of injury or material damage should the unit be used improperly. * Material damage refers to damage or other adverse effects caused with respect to the home and all its furnishings, as well to domestic animals or pets.

## About the Symbols

	The  symbol alerts the user to items that must never be carried out (are forbidden). The specific thing that must not be done is indicated by the design contained within the circle. The symbol at left means the unit must never be disassembled.
	The  symbol alerts the user to things that must be carried out. The specific thing that must be done is indicated by the design contained within the circle. The symbol at left means the power-cord plug must be unplugged from the outlet.

The following symbols are also used.

**NOTICE** : Indicates information to prevent machine breakdown or malfunction and ensure correct use.



: Indicates a handy tip or advice regarding use.

## WARNING



### **Do not disassemble, repair, or modify.**

Doing so may lead to fire or abnormal operation resulting in injury.

Class 2 laser light may be emitted outside the machine. Staring directly into the laser beam for an excessive length of time may result in eye injury.



### **Do not use while in an abnormal state (i.e., emitting smoke, burning odor, unusual noise, or the like).**

Doing so may result in fire or electrical shock. Immediately unplug the power-cord plug from the electrical outlet, and contact your authorized Roland DG Corp. dealer or service center.



### **Do not use with any electrical power supply that does not meet the ratings displayed on the AC adapter.**

Use with any other power supply may lead to fire or electrocution.



### **Use only with the power cord included with this product.**

Use with other than the included power cord may lead to fire or electrocution.



### **Do not use with any power supply other than the dedicated AC adapter.**

Use with any other power supply may lead to fire or electrocution.

## CAUTION



### **Do not use with a damaged AC adapter, power cord, or power-cord plug or with a loose electrical outlet.**

Use with any other power supply may lead to fire or electrocution.

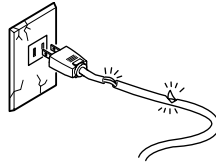

### **Do not injure or modify the electrical power cord, nor subject it to excessive bends, twists, pulls, binding, or pinching, nor place any object of weight on it.**

Doing so may damage the electrical power cord, leading to electrocution or fire.

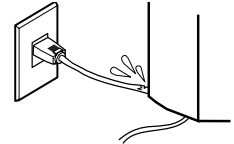

### **When not in use for several hours, unplug the power-cord plug from the electrical outlet.**

Failure to do so may result in danger of shock, electrocution, or fire due to deterioration of the electrical insulation.

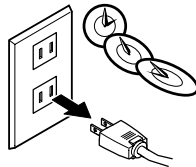

### **When unplugging the electrical power cord from the power outlet, grasp the plug, not the cord.**

Unplugging by pulling the cord may damage it, leading to fire or electrocution.



### **Do not attempt to unplug the power-cord plug with wet hands.**

Doing so may result in electrical shock.

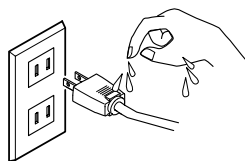

### **Install on a stable surface.**

Failure to do so may result in falling of the unit, leading to injury.

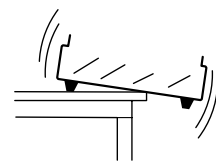

---

## CAUTION



**Do not insert metal objects, flammable objects, or any other foreign object into interior areas other than the top of the table. Also, do not place water or other liquids on any area, including the table.**

Doing so may cause fire.



**Do not use if the housing or window area is cracked or deformed.**

In such cases, there is danger of external emission of Class 2 laser light. Staring at externally emitted laser light may cause eye injury.



**Lifting and carrying are operations that must be carried out by two persons, by grasping the bottom of the machine.**

Failing to do so may result in injury.



**Securely fasten the object to be scanned to the table so that it does not slip or topple over.**

The table rotates during scanning. Tipover or contact by the scan object may cause damage. Scan-object damage is not covered by warranty.



**Do not attempt to scan objects that are highly reflective or refractive, such as mirrors, prisms, or lenses.**

In such cases, there is danger of external emission of Class 2 laser light. Staring at externally emitted laser light may cause eye injury.

## ■ Important Cautions Regarding Laser Light

This machine uses a laser beam to scan objects, but dangerous laser radiation is not emitted outside the machine. It is safe to view the laser light through the window.

However, this may not be the case if the machine is disassembled or if its cover or safety devices are broken or disabled. Please observe the cautionary notes in this documentation and never attempt to use this machine if the machine is in an abnormal state.

The natural blink reflex protects the eye in the event that laser light from the machine directly enters the eye due to incorrect use or the like, but staring directly into the laser beam may result in eye injury. Direct contact with the laser beam will not cause burns or fire.

---

## Items That may Not Be Copied

Unauthorized reproduction of a copyrighted item for any purpose other than personal use may be a violation of copyright. Roland DG Corp. will not be responsible for any violation of third-party copyright by any article made through use of this product.

## About the Labels Affixed to the AC Adapter and Unit

This machine bears caution labels. These are intended to ensure the safety of the operator. They must be affixed at the appropriate locations. Do not allow them to become soiled or attempt to peel them off. Also, be sure to observe the stated cautions during use.

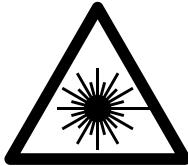

This product complies with 21 CFR chapter I Subchapter J.



Model name

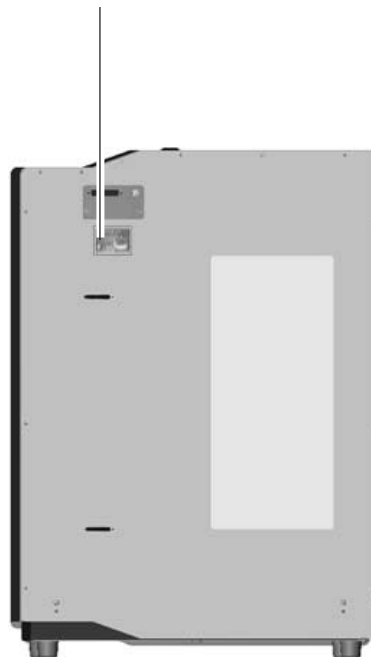

<p><b>▲ CAUTION</b> DISCONNECT MAIN PLUG FROM SUPPLY SOCKET WHEN NOT IN USE MAIN LEADS COLOR CODE: BROWN: LIVE, BLUE: NEUTRAL</p> <p><b>▲ ATTENTION</b> Quand la machine n'est pas utilisée déconnecter le câble de la prise de courant Code des couleurs Marron: Phase, Bleu: Neutre</p>	<p><b>▲ ACHTUNG</b> Lösen Sie den Netzanschluß, wenn das Gerät nicht verwendet wird. Die Farbkodierung des Netzkabels lautet folgendermaßen: Braun: Spannung, Blau: Masse</p> <p><b>▲ 注意</b> 長時間使用しない場合は、ACアダプタをコンセントから抜いて下さい。</p>
---	--

Rating label

Do not use with any electrical power supply that does not meet the ratings displayed on the AC adapter.

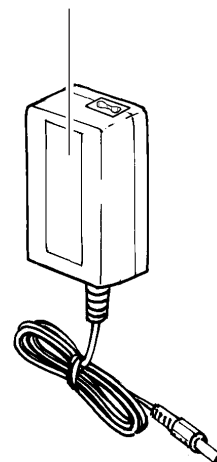
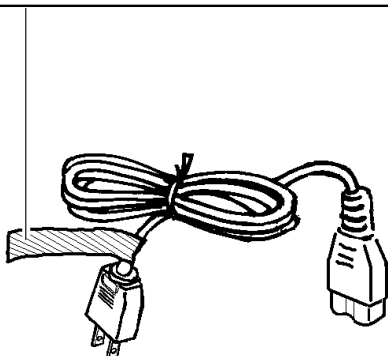

# Table of Contents

<b>Part 1 Startup</b>	
1. Checking the Accessories .....	1
2. Three Manuals for Using the LPX-250 .....	2
3. LPX-250 System Configuration .....	3
4. Names and Functions .....	4
5. Installation and Cable Connections .....	5
Removing the Head Retainers and Installing .....	5
Connect the Cable .....	6
6. Switching the Power On and Off	
<b>and Opening and Closing the Door</b> .....	8
Steps for Switching On the Power .....	8
Switching Off the Power .....	8
Opening and Closing the Door .....	8
7. Preparing the Programs .....	9
Programs Installed and Set Up .....	9
System Requirements .....	9
Steps for Installing and Setting Up the Programs .....	10
Starting Dr. PICZA3 .....	10
Selecting the Communication Port .....	10
<b>Part 2 Basics of the LPX-250</b>	
1. Scanning System .....	11
2. Suitable and Unsuitable Objects for Scanning .....	12
3. Plane Scanning .....	13
Feature of Plane Scanning .....	13
Mounting Orientation for the Scan Object .....	13
4. Rotary Scanning .....	14
Features of Rotary Scanning .....	14
Finishing by Rescanning .....	14
5. Mounted Position of the Object	
<b>and the Scannable Area</b> .....	15
Plane Scanning .....	15
Rotary Scanning .....	16
Effective Sensor Area .....	16
<b>Part 3 Basic Operation</b>	
1. Getting Ready to Scan .....	17
Selecting a Scan Object .....	17
Deciding on the Scanning Mode .....	17
Mounting the Scan Object .....	17
2. Scanning Operation .....	18
3. Viewing the Results of Scanning .....	19
Manipulating the Perspective and the Zoom Rate .....	19
Changing the Display Method .....	19
4. Saving Data .....	20
Saving in Dr. PICZA Format .....	20
Exporting Data .....	20
<b>Part 4 Features for Better Scanning</b>	
1. Detailed Settings for Plane Scanning .....	21
Scanning Using Manual Settings .....	21
Detailed Scanning Conditions .....	22
2. Detailed Settings for Rotary Scanning .....	23
Scanning Using Manual Settings .....	23
Detailed Scanning Conditions .....	24
3. Finishing Detailed Areas Using Rescanning .....	25
Finishing Areas That Could Not Be Scanned .....	25
Scanning a Specific Area in Greater Detail .....	27
4. Case Studies for Better Scanning .....	28
Scanning Results for Objects That Are Difficult to Scan .....	28
Choosing the Scanning Mode .....	28
The Scanning-start Direction for Plane Scanning .....	30
Object Mounting Location for Rotary Scanning .....	31
<b>Part 5 Editing Scanning Results - Using 3D Editor</b>	
1. What You Can Do Using 3D Editor .....	32
2. Importing and Exporting Data .....	32
Importing Scanning Results Immediately .....	32
Importing More Than One Set of Data .....	33
Exporting Data in Other Formats .....	33
3. Basic Operations for Objects .....	34
How to View the 3D Editor Window .....	34
Let's Try Editing Data with 3D Editor .....	35
<b>Part 6 Troubleshooting</b> .....	37
<b>Part 7 Appendix</b>	
1. Sample Data Sheet .....	39
2. Table Dimensional Drawing .....	40
3. Specifications .....	41

Windows® and Windows NT® are registered trademarks or trademarks of Microsoft® Corporation in the United States and/or other countries.

Adobe and Acrobat are trademark of Adobe Systems Incorporated.

Pentium is registered trademark of Intel Corporation in the United States.

IBM is trademark of International Business Machines Corporation.



Other company names and product name are trademarks or registered trademarks of their respective holders.

# Part 1

## Startup

### 1. Checking the Accessories

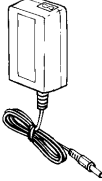
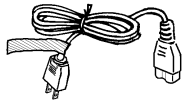
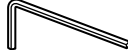
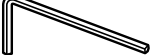
The following included items are packed with the LPX-250. Check first to make sure that all items are present.

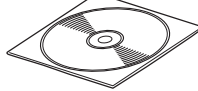
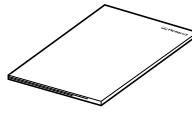
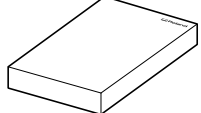
 <p>AC adapter : 1</p>	 <p>Power cord : 1</p>	 <p>Hexagonal wrench (size : 2.5 mm) : 1</p>	 <p>Hexagonal wrench (size : 3 mm) : 1</p>
 <p>Caps : 3</p>	 <p>CD-ROM (Roland Software Package) : 1</p>	 <p>User's Manual : 1</p>	 <p>Roland Pixform™ : 1</p>



#### The Contents of the CD-ROM

The included CD-ROM contains the following items.

- Dr. PICZA3 program
- 3D Editor program
- Dr. PICZA3 User's Manual (PDF)
- 3D Editor User's Manual (PDF)
- Adobe Acrobat Reader ver. 4 program

Also included are programs and documentation for MODELA series modeling machines from Roland DG Corp., but they are not for use with the LPX-250.

## 2. Three Manuals for Using the LPX-250

Three manuals are included with this machine.

<b>LPX-250 User's Manual (this manual)</b>	Read this first. This describes important notes, setup, operation, troubleshooting, and other matters related to using the LPX-250.
<b>Dr. PICZA3 User's Manual (electronic-format manual)</b>	Refer to these as required. They describe in detail all the functions of the included Dr. PICZA3 and 3D Editor programs.
<b>3D Editor User's Manual (electronic-format manual)</b>	These manuals are in electronic (PDF) format, and printed versions are not included. They are found on the included "Roland Software Package" CD-ROM. You can easily view them or even print them out by following the steps below. You can also view the same information from the online help for each program.



### Viewing the Included Electronic Documentation (PDF Format)

1. Insert the included CD-ROM into the computer's CD-ROM drive. A menu window appears automatically.
2. Click the place that says "Click here," then select "LPX-250."
3. Click the [?] button to the right of the program name. Acrobat Reader starts and the window for choosing the manual appears. Click the item you want to view.

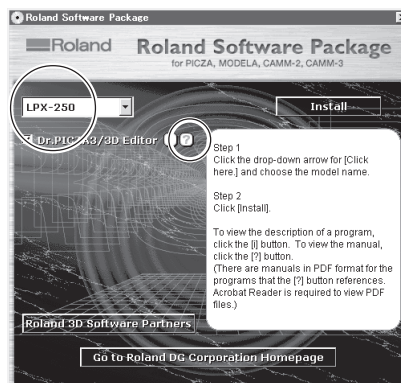

4. When you are viewing for the first time, installation and setup of Acrobat Reader may start. If this happens, follow the on-screen instructions to proceed with installation and setup.
5. You can go on to the next page or go back to the previous page by pressing the left and right arrow keys on the keyboard. (You can also do this using the on-screen [◀] and [▶] buttons.)

### About Adobe Acrobat Reader

Acrobat Reader is a program required to view files in PDF format. Acrobat Reader is found on the included CD-ROM. If Acrobat Reader is not set up on the computer you're using, then it is installed automatically to enable you to view the manual easily, no matter what kind of computer you're using.

\* Acrobat Reader is a product of Adobe Systems Incorporated. For detailed information on how to use it, go to the Acrobat Reader menu and select [Help] to view the online help.

# 3. LPX-250 System Configuration

The LPX-250 system is made up of the 3D scanner unit, a computer running Windows (available separately), a scanning program, and a program for editing 3D data.

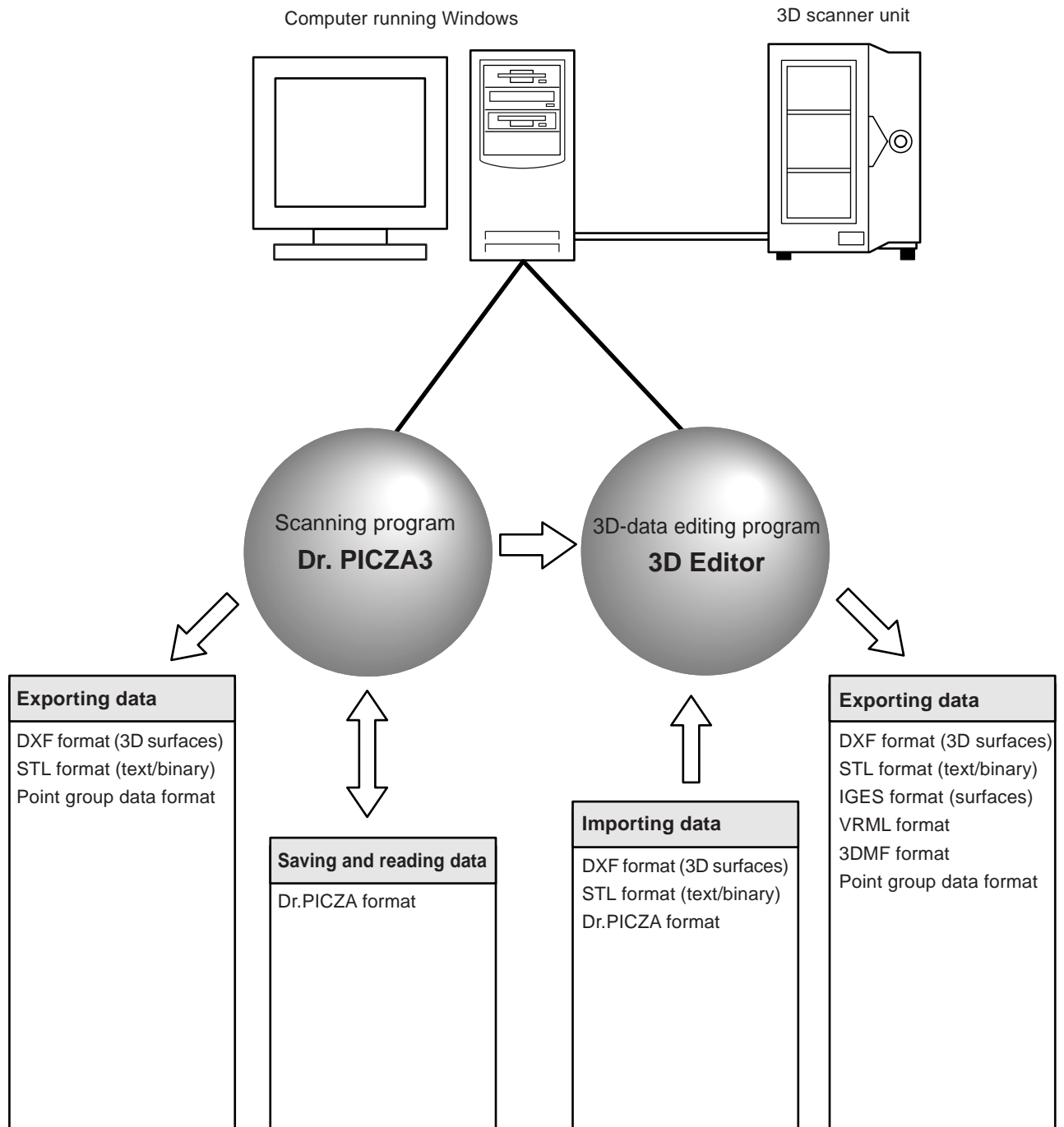

## 4. Names and Functions

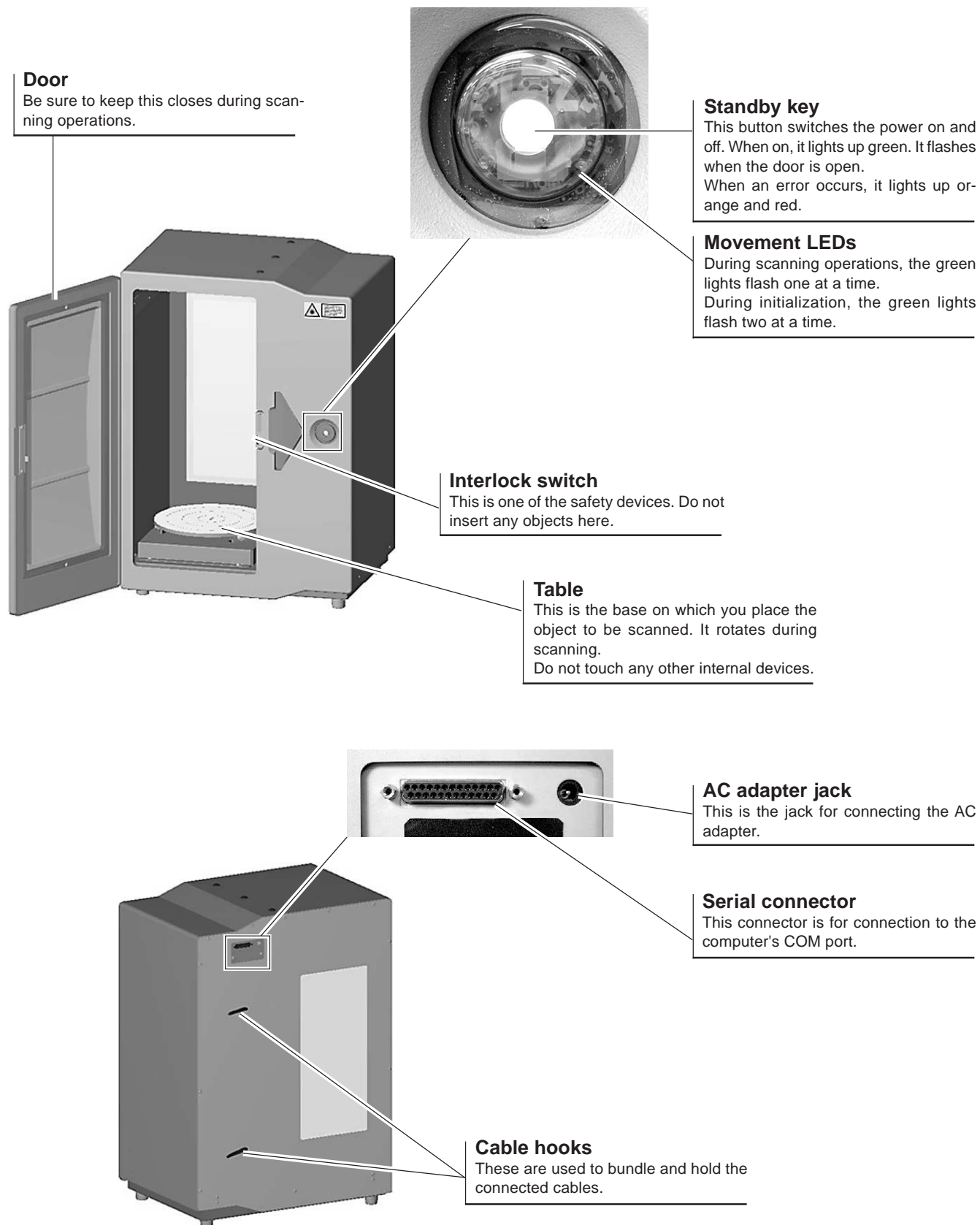

# 5. Installation and Cable Connections

## Removing the Head Retainers and Installing

### CAUTION



Lifting and carrying are operations that must be carried out by two persons, by grasping the bottom of the machine. Failing to do so may result in injury.

### NOTICE

Be sure to remove the head retainers before use. Failure to remove them may not only impede operation, but may cause breakdown.

Do not attempt to touch any internal area other than the items described below, or to use excessive force to move any item. Doing so may result in breakdown.

After you take the machine out of the carton, the first thing you need to do is to remove the head retainers. Carry out this operation before you connect the AC adapter. When transporting the machine, reattach the head retainers. Store the head retainers in a safe place so that they do not get lost.

1. Use the hexagonal wrench (3 mm) to remove the three screws, then detach head retainer 1.
2. Attach the three included caps.
3. Open the door. The blue panel visible to the right of the table at the back is head retainer 2. Use the hexagonal wrench (2.5 mm) to remove the five screws, then detach head retainer 2.
4. Remove head retainer 3, which is blue and located at the top of the head unit. Use the hexagonal wrench (3 mm) to remove one screw, then pull head retainer 3 up and out to extract it. Take care not to drop the retainer when extracting it.

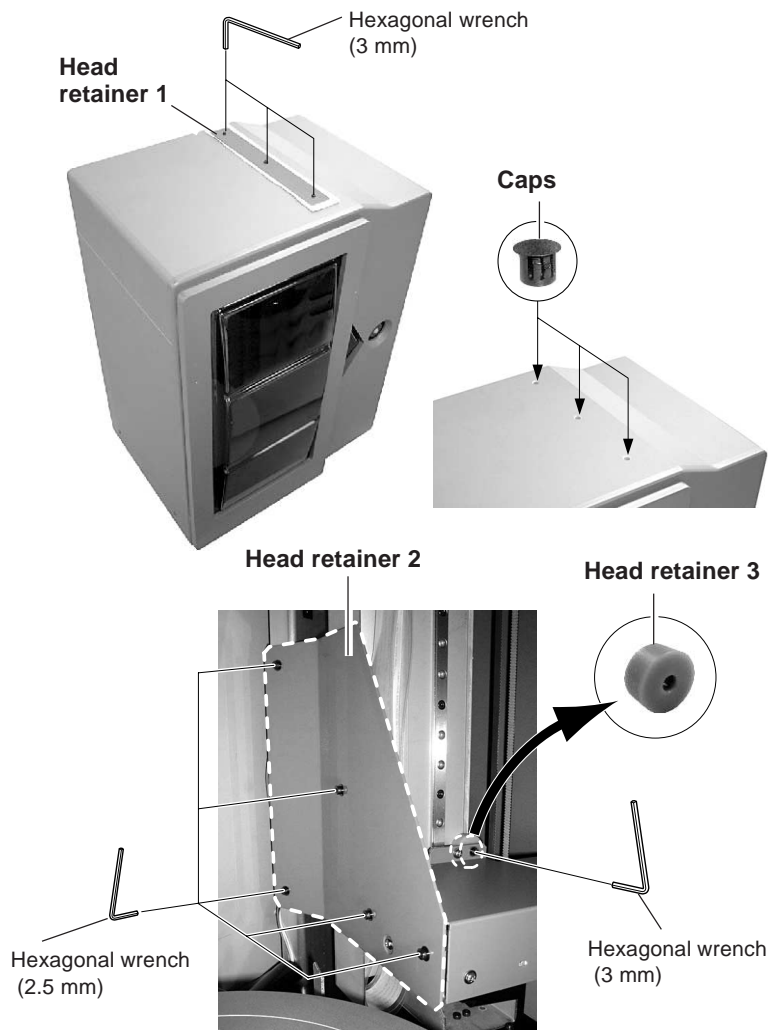



### NOTICE

When installing, be careful of the following points.



- Do not install in an unstable location. Doing so may not only lead to danger of falling, but may result in breakdown or malfunction.
- Avoid use in locations exposed to large amounts of electrical noise, such as areas near motors.
- Do not install in a location exposed to high humidity or dust.
- Because the machine generates heat when in use, do not install in a location where heat radiation is poor.
- Do not install in locations exposed to severe vibration.
- Use in an environment where temperature is between 10 °C and 40 °C (between 50 °F and 104 °F) and relative humidity is between 35 % and 85 % (with no condensation).
- Avoid using in an environment exposed to severe changes in temperature. Such use may affect scanning accuracy.

## Connect the Cable

### **WARNING**

-  Do not use with any power supply other than the dedicated AC adapter.  
Use with any other power supply may lead to fire or electrocution.
-  Do not use with any electrical power supply that does not meet the ratings displayed on the AC adapter.  
Use with any other power supply may lead to fire or electrocution.
-  Use only with the power cord included with this product.  
Use with other than the included power cord may lead to fire or electrocution.

### **CAUTION**

-  Do not injure or modify the electrical power cord, nor subject it to excessive bends, twists, pulls, binding, or pinching, nor place any object of weight on it.  
Doing so may damage the electrical power cord, leading to electrocution or fire.
-  Do not attempt to unplug the power-cord plug with wet hands.  
Doing so may result in electrical shock.

Connect the power cord and the AC adapter.

Also make the connection to the computer's COM port (RS-232C port, serial port). The computer may have two or more COM ports, so make sure of the number of the connected COM port.

Use a serial cable from Roland DG Corp. sold separately (for an IBM-compatible computer, use a crossover cable such as the XY-RS-34). Straight-wired cables like those used mainly for modem connections cannot be used for operation.

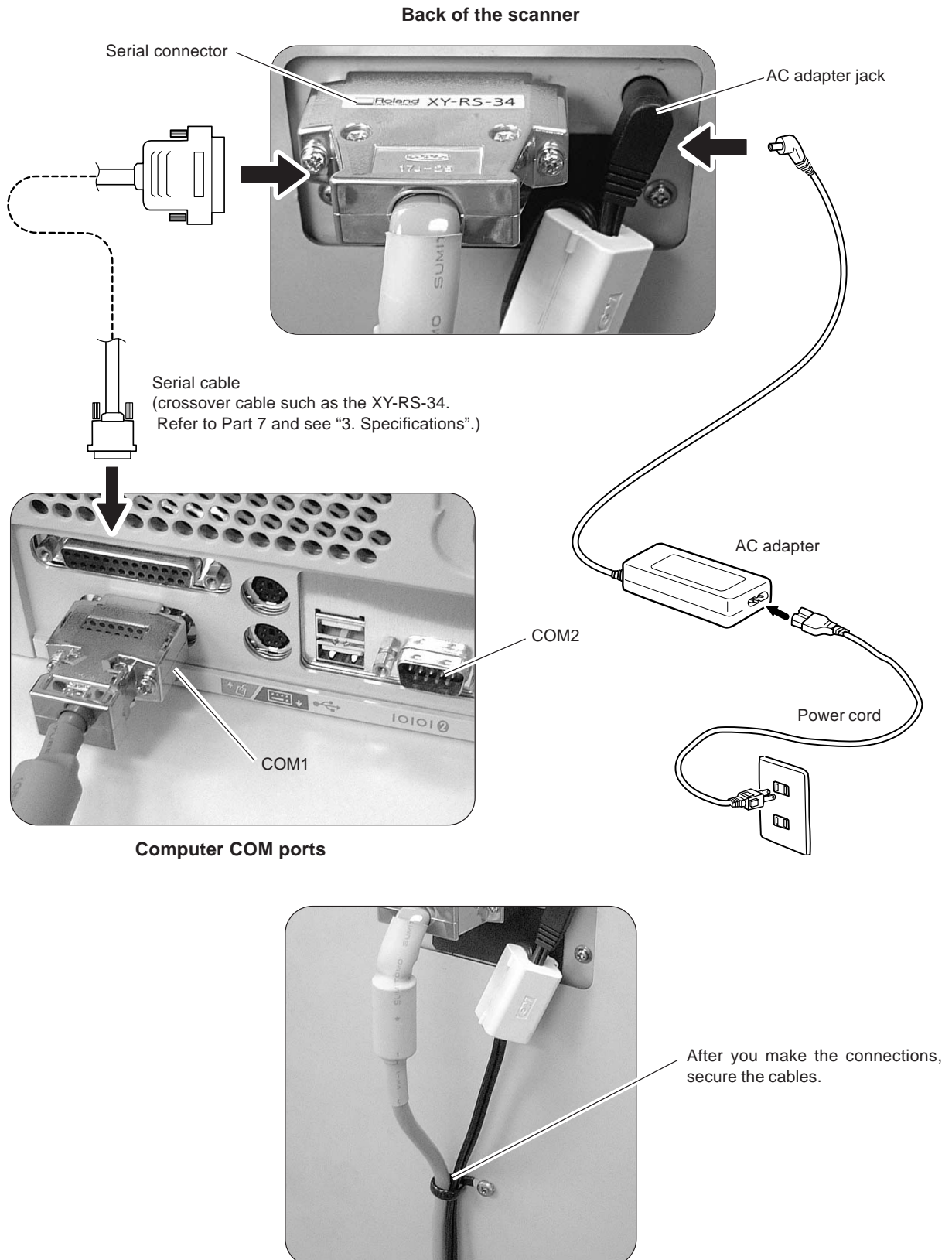
**NOTICE**

Connect the AC adapter and power cord securely so that they do not come loose or experience faulty connection. Failure to do so may result in breakdown or malfunction.

Switch off the power to the computer and the machine before you make the cable connections.

Be sure to make the connection to a COM port. Connection to an incorrect port such as a printer port, may not only result in the system failing to operate, but may lead to breakdown.

## 6. Switching the Power On and Off and Opening and Closing the Door

### Steps for Switching On the Power

There is a proper procedure for switching on the power to the machine. Follow the steps below.

1. Close the door.
2. Press the Standby key.
3. The Movement LEDs flash. Keep the door closed until the flashing stops. During this interval, the machine is performing initialization.
4. When initialization ends, the Standby key lights up green and the Movement LEDs go dark. Scanning is now possible.

Movement LEDs

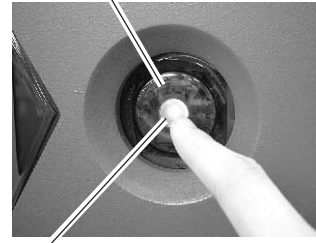

Standby key

#### NOTICE

Initialization may take up to about 40 seconds. If the door is opened during initialization, operation is interrupted to ensure safety. In such cases, correct scanning cannot be performed. Switch off the power, close the door, then switch the power on again. Also, sound that is different from what you usually hear may be heard for several seconds during initialization, but this does not indicate a malfunction.

Starting the computer after switching on the machine may make it impossible to perform scanning. This may occur depending on the computer, but does not indicate a malfunction. If this happens, start the computer first, and then switch on the power to the machine. Also, if the computer is restarted, reset the power to the machine as well.

### Switching Off the Power

#### CAUTION



When the machine will not be in use for a prolonged period, unplug the power cord from the electrical outlet. Failure to do so may result in deterioration of the insulation, leading to electrical shock, short circuit, or fire.

Hold down the Standby key for 1 second or longer.

### Opening and Closing the Door

When you open the door, the Standby key flashes green. Scanning cannot be performed while in this state. Close the door, then start scanning.

To ensure safety, an emergency stop occurs when the door is opened while scanning is in progress. Scanning cannot be resumed even after the door is closed.

#### NOTICE

If the Standby key does not flash when you open the door, the safety device may have failed. If this happens, immediately stop use and contact your authorized Roland DG Corp. dealer or service center.

# 7. Preparing the Programs

## Programs Installed and Set Up

Dr. PICZA3 and 3D Editor are both installed and set up.

## System Requirements

The computer's system requirements for Dr. PICZA3 and 3D Editor are as follows.

<b>Operating system</b>	Windows 95, Windows 98, Windows Me, Windows NT 4.0, and Windows 2000
<b>Processor</b>	Pentium or higher recommended
<b>Memory (RAM)</b>	64 MB or more recommended
<b>Free hard-disk space for installation</b>	10 MB (for both Dr. PICZA3 and 3D Editor)
<b>Monitor</b>	640 x 480 resolution, 256 colors or higher (800 x 600 resolution or higher, 16-bit color (High Color) or higher, and OpenGL-compatible or more recommended)
<b>Interface</b>	COM port (Serial port)

\* Memory requirement are affected by scanning conditions and the like. Larger scanning areas and finer scanning pitches require increasingly more memory. We recommend installing enough memory to match your usage conditions.

## Steps for Installing and Setting Up the Programs

1. Insert the included CD-ROM (Roland Software Package) into the computer's CD-ROM drive. The setup menu appears automatically.
2. Click the place that says "Click here," then select "LPX-250."
3. Click the [Install] button.



4. Follow the on-screen setup instructions, clicking the [Next] button to proceed. If you want to specify a particular folder for installation, do it here. In most cases you can simply click [Next] to proceed. Installation starts.
5. When all installation and setup finishes, the final window appear. Click [Close] to finish setup.

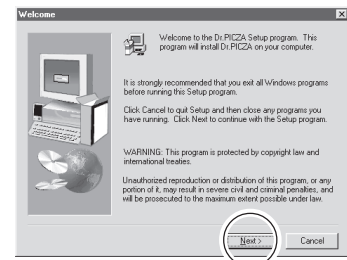

## Starting Dr. PICZA3

1. First switch on the power to the LPX-250.
2. Next, in Windows, click the [Start] button, then click [Programs], then [Roland PICZA], then [Dr. PICZA3].



When Dr. PICZA3 starts, it attempts to verify the name of the model of the 3D scanner that is connected. Be sure to turn on the LPX-250 before you run Dr. PICZA3.

With this system, the [Run MODELA Player] and [Run 3D Engrave] buttons in Dr. PICZA3 are not used. Use them when you are using together with the MODELA series or the like.

## Selecting the Communication Port

1. In Dr. PICZA3, go to the [File] menu and click [Preferences].
2. For [Port], select the number of the COM port on the computer to which the LPX-250 is connected.
3. Click [OK]. The LPX-250 can now perform scanning.

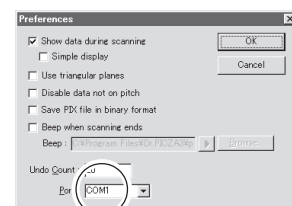

### Special Notes for Windows NT 4.0/2000

Care is required when another printer driver or the like is set to use a COM port. Scanning cannot be performed when the same COM port is selected for the other driver and Dr. PICZA3. Take action such as connecting to a different COM port to avoid conflicts with the other driver.

### Checking the Connection

In Dr. PICZA3, go to the [Help] menu and display [About]. If the firmware version and model name are displayed, the connection is correct.

## Part 2

# Basics of the LPX-250

## 1. Scanning System

The LPX-250 scans objects using laser light. It emits a spot beam onto the scan object and detects reflected light from the object with sensors. It performs scanning as it rotates the scan object and moves the laser beam from bottom to top.

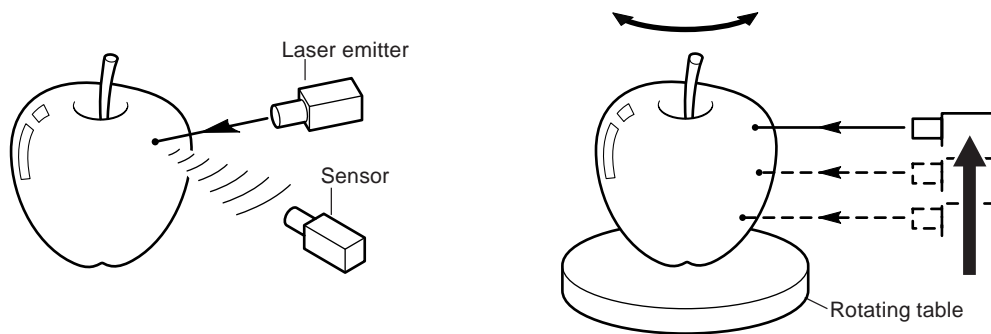

The LPX-250 has two scanning modes. Each has its own features, so you can choose the optimal scanning mode for the object to be scanned.

## 2. Suitable and Unsuitable Objects for Scanning

The LPX-250 cannot scan every single kind of object. Adequate thought must be given to the material of an object, because it greatly affects the scanning results.

<b>Yes</b>	Objects that do not pass light
<b>No</b>	Clear or transparent objects
* Applying white surfacer (primer) may produce better results.	

<b>Yes</b>	Relatively smooth-surfaced objects
<b>No</b>	Fabric or fuzzy objects

<b>Yes</b>	Brightly colored objects (white, yellow, red, etc.)
<b>No</b>	Dark-colored objects (black, blue, green, etc.)
* Applying white surfacer (primer) may produce better results.	

<b>Yes</b>	Objects of a nonglossy material such as plaster, wood, or modeling clay
<b>No</b>	Glossy and highly reflective objects (metals, mirrors, etc.)
* Applying white surfacer (primer) may produce better results. * Avoid highly reflective objects because of danger of eye injury.	

<b>No</b>	Areas where the angle of the laser beam is too shallow

# 3. Plane Scanning

## Features of Plane Scanning

This mode uses parallel laser beams to scan while rotating the table and laser head in synchronization. Because this mode can obtain comparatively stable scanning results regardless of the shape of the object, you can use it as an all-purpose mode. You can use it to scan up to six surfaces at one time (multi-plane composition).

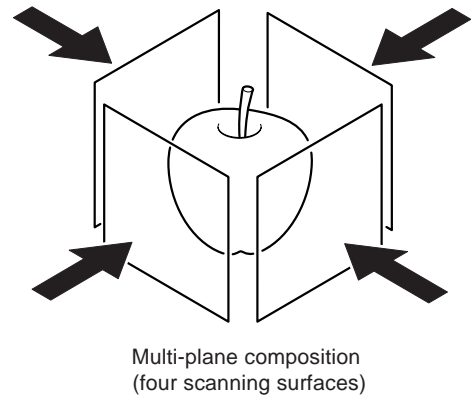
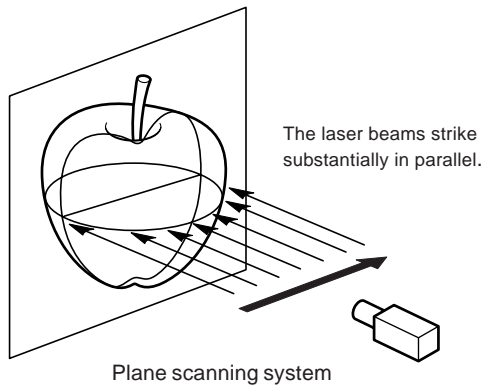

## Mounting Orientation for the Scan Object

When the object to be scanned has areas with cavities or voids, plane scanning, which uses parallel laser beams, is effective. This is because the laser light can easily pass through the voids. However, if the laser light is blocked by another area, it becomes impossible to determine that the void exists. This means the direction from which the laser light is beamed is very important.

If you are scanning a doll, for instance, you can capture the voids between the legs and under the arms by aiming the laser light in the direction shown in figure A. If the orientation in figure B is used, the laser light is blocked and so the two legs end up joined.

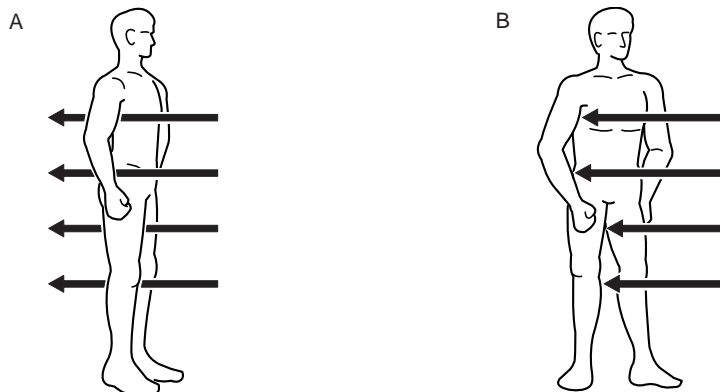

The laser light is emitted from the right side. This means that if your aim is to capture the void between the legs, for example, it is best to mount the doll so that it faces right. The direction in which the laser light is incident is decided by the orientation of the scan object mounted on the table. With multi-plane composition, this orientation is the first surface for scanning.

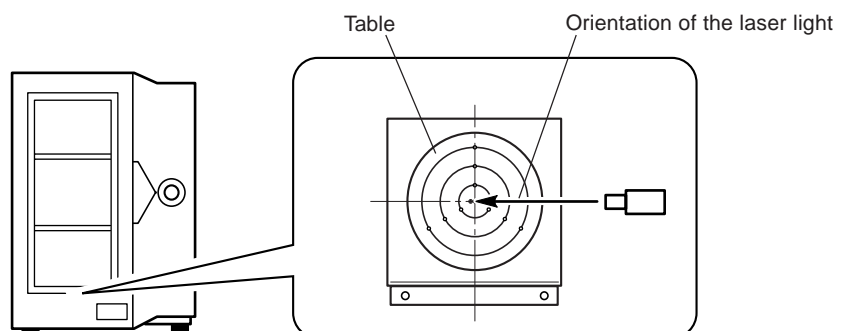

In general, increasing the number of scanning surfaces results in greater scanning precision with correspondingly fewer conspicuous seams. In the example of the doll, however, only one of the five scanning surfaces can capture the voids. From the standpoint of capturing voids, two surfaces are more effective.

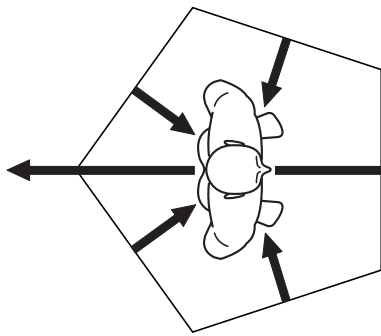

Scanning surfaces: 5

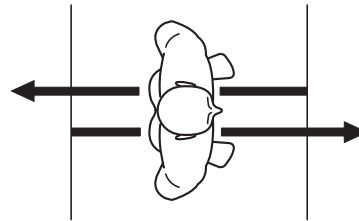

Scanning surfaces: 2

## 4. Rotary Scanning

### Features of Rotary Scanning

This mode scans the outer perimeter of the scan object while rotating the table in one direction. This is suited to scanning objects that have relatively little unevenness and are close in shape to a sphere or cylinder, and lets you perform smooth scanning for curved surfaces. It is more selective of the shape of the object than plane scanning, but conversely reproduces smooth curves even at relatively coarse pitches, and also takes less time. Capturing cavities and voids in objects is more difficult than with plane scanning.

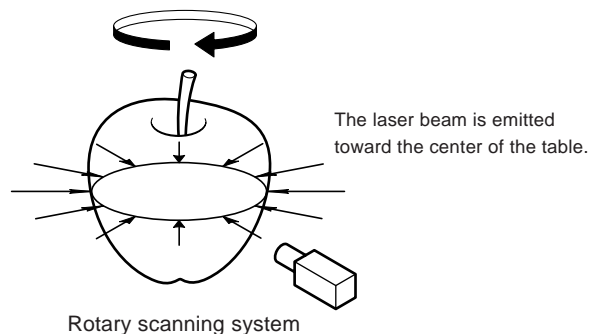

### Finishing by Rescanning

If the object is highly uneven, there may be many areas that the laser light does not reach. Rotary scanning is more likely to be affected by this than plane scanning, and may result patches that are not scanned. With rotary scanning, you can finish such areas by rescanning. Perform rotary scanning for the entire object, then rescan only the areas you want to finish. This enables scanning with an attractive finish even for detailed portions while smoothly reproducing the curved features of the entire object.

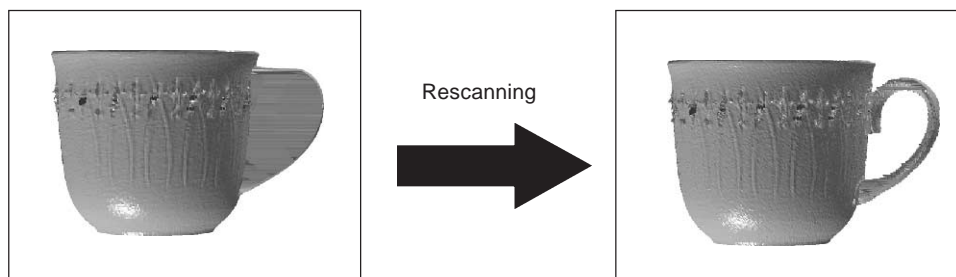

## 5. Mounted Position of the Object and the Scannable Area

The scannable area may differ slightly according to the scanning mode. The area that you can actually scan is affected by the mounted position of the object. Also, mount the object so that it does not extend beyond the table.

### Plane Scanning

#### Multi-plane Composition (Two to Six Scanning Surfaces)

For multi-plane composition, mount the object near the center of the table. If it is mounted at the edge of the table it will fall outside the effective sensor area, making correct scanning impossible.

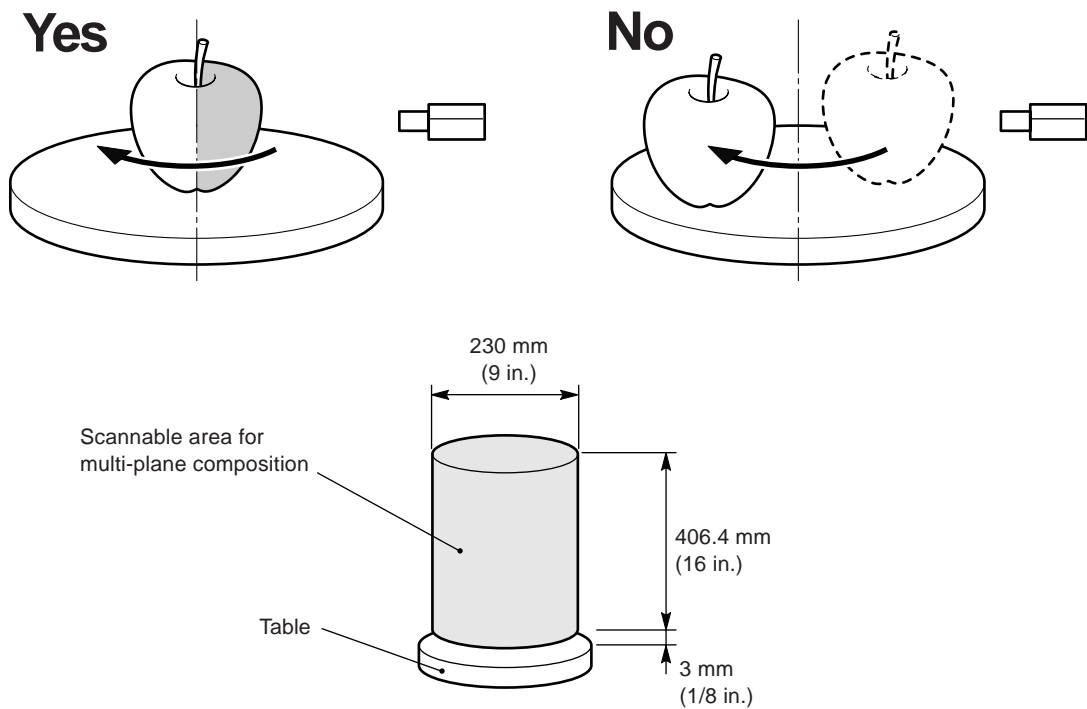

#### When There Is a Single Scanning Surface

When you are scanning only one surface, mount the object so that the surface you want to scan lies to the right of the center of the table.

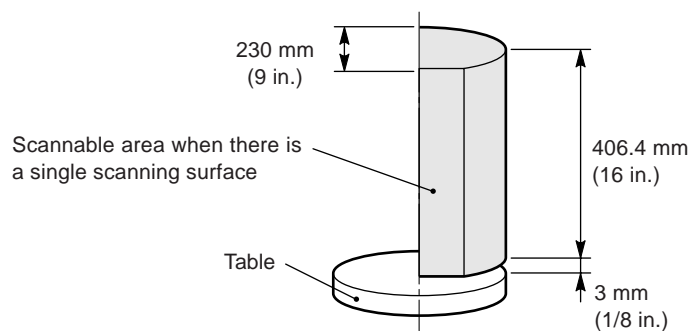

## Rotary Scanning

The basic principle is to mount the object to be scanned at the center of the table. All areas to be scanned must be at the table center. The area away from the center of the base (the shaded portion in the figure) cannot be scanned correctly.

**Yes**

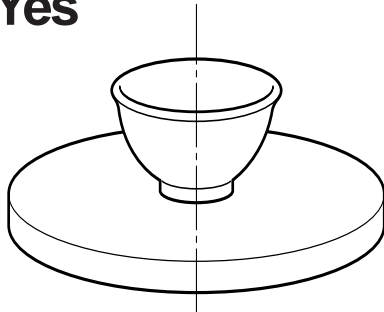

**No**

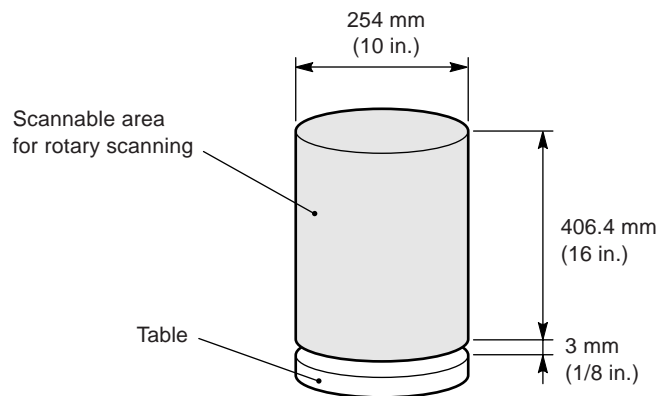
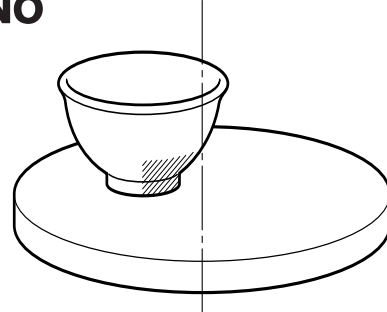

## Effective Sensor Area

The area where the laser sensor detects reflected laser light is to the right of the center of the table. This is the effective sensor area. When laser light is reflected from the area to the left of the table center, the LPX-250 decides that there is no object to scan. The surface of an object mounted at the table center always passes within the effective sensor area, and the laser light is always reflected from the area to the right. This effective sensor area must also be taken into account when the object has large depressions or shelf-shaped areas.

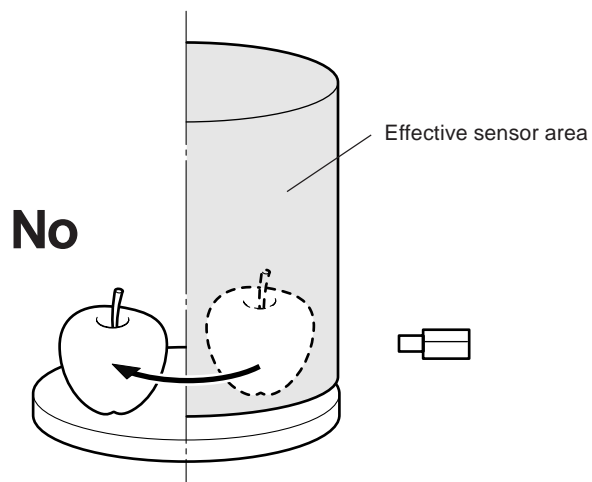

## Part 3

# Basic Operation

## 1. Getting Ready to Scan

### Selecting a Scan Object

Before you start scanning, give thought to what objects are suited to scanning.

	Conditions for suitable scanning	Remedies when unsuitable
<b>Object material and color</b>	Does the objects not pass light? Is the object a bright color such as white or yellow? Is the object of a nonglossy material?	Consider applying a white surfacer (primer).
<b>Object size</b>	Does the object fit on the table?	Think about whether you can break down the object into separate parts.
<b>Object shape</b>	Can the object be placed on the table in a stable way? Does the object have many areas that laser light cannot reach?	Consider using a fixing frame or clay to secure in place. Think about whether you can break down the object into separate parts.

### Deciding on the Scanning Mode

Give thought to whether to perform scanning in the plane scan mode or the rotary scan mode. In general, it is a good idea to select rotary scanning for objects that are nearly cylindrical and have relatively little unevenness, and plane scanning for other objects.

If an object is nearly cylindrical overall but has one or more areas that are not suited to rotary scanning (such as the handle of a coffee cup), you may consider using rotary scanning to scan the entire object, then using rescan for finishing. For detailed information about rescanning, go to Part 4 and refer to "3. Finishing Detailed Areas Using Rescanning."

### Mounting the Scan Object

#### CAUTION



Do not insert metal objects, flammable objects, or any other foreign object into interior areas other than the top of the table. Also, do not place water or other liquids on any area, including the table. Doing so may cause fire.



Securely fasten the object to be scanned to the table so that it does not slip or topple over. The table rotates during scanning. Tipover or contact by the scan object may cause damage. Scan-object damage is not covered by warranty.

Mount the scan object near the center of the table. For Rotary scanning in particular, mounting the object away from the center may make it difficult to obtain good scanning results.

The table rotates during scanning, so secure the object in place using double-sided tape, clay, or an optionally available vise to keep the object from falling over or slipping.

**NOTICE**

Do not touch any internal components other than the table. Doing so may result in breakdown.

Do not attempt to move the table, laser head, or any other working parts by hand. Doing so may result in breakdown.

Make sure the scan object does not extend beyond the table. The object may touch the interior of the machine, causing breakdown or damaging the scan object.

## 2. Scanning Operation

**NOTICE**

Do not open the door while scanning operations are in progress. To ensure safety, an emergency stop of scanning operations occurs. Scanning cannot be resumed even after the door is closed.

This section describes how to set the scanning conditions automatically. You can also set detailed scanning conditions manually. For more information, see Part 4.

1. In Dr. PICZA3, click the [SCAN] button. The [Scan] dialog box appears.

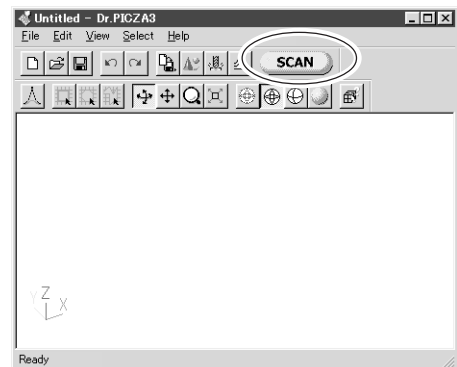

2. Click either the Plane Scanning or the Rotary Scanning button. Scanning starts.
3. Examine the results of scanning. As required, perform finishing by rescanning (for rotary scanning only), or modify the scanning conditions and do scanning over from the beginning. For more information about viewing the scanning results, refer to the following section, "3. Viewing the Results of Scanning." For information about rescanning and changing the scanning conditions, see Part 4.

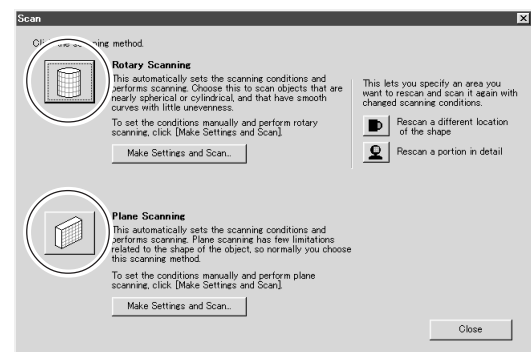

### Automatic Setting of Scanning Conditions

In this operation, the size of the scan object is detected and the scanning area is set automatically. The scanning pitch is also automatically adjusted according to the size of the object. For plane scanning, the number of scan surfaces is always four.

If the object has a highly irregular shape or long, narrow protrusions, the size may not be detected correctly. If this happens, then perform scanning using settings made manually, as described in Part 4.

### Verifying the Scanning Conditions

You can check and verify the scanning conditions that were set automatically. After scanning has finished, go to the [Scan] dialog box and click the [Make Settings and Scan] button. Here you can revise the scanning conditions and redo scanning using new conditions. For detailed information about scanning conditions, go to Part 4 and refer to "1. Detailed Settings for Plane Scanning" and "2. Detailed Settings for Rotary Scanning."

## 3. Viewing the Results of Scanning

You can check the scanning results while viewing the results in various ways.

### Manipulating the Perspective and the Zoom Rate

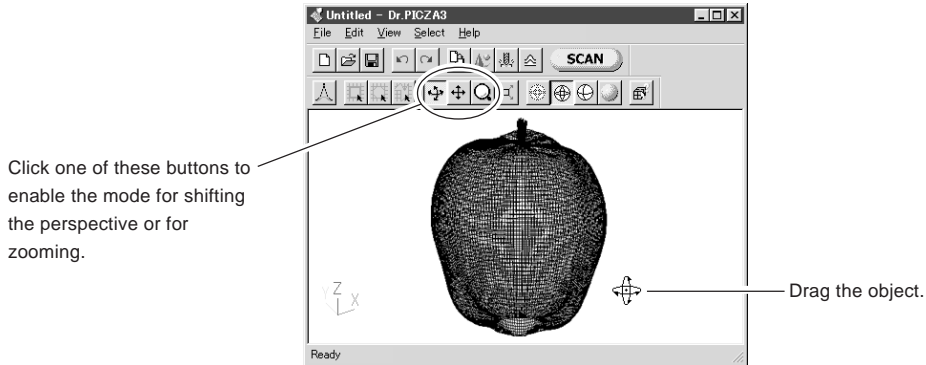

### Changing the Display Method

Clicking these buttons changes the display method.

- [Point Group] button** This displays the scanning points as points.
- [Wire Frame] button** This displays the scanning results using wire-frame lines.
- [Hide Lines] button** This uses wire-frame lines but does not show areas that are in shadow.
- [Rendering] button** This displays surfaces and provides a view that most closely resembles the actual article.

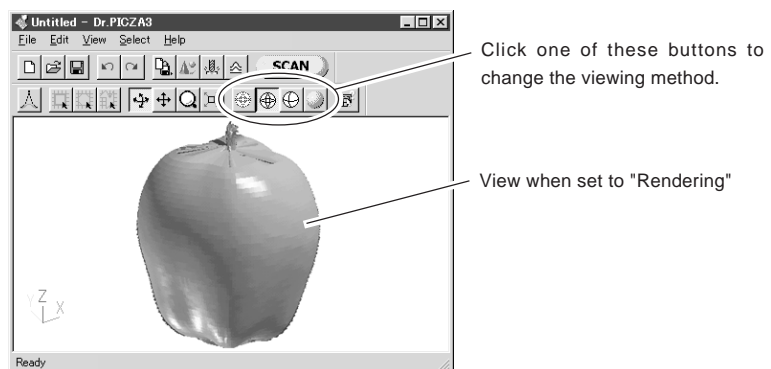

#### Speeding Up Screen Display

If the operating system and graphics card support OpenGL and the like, it may be possible for you to speed up the screen display. Make the settings as follows.

1. In Dr. PICZA3, go to the [View] menu and click [Options].
2. For [Drawing Method], select OpenGL or the like, then click [OK].
3. If the screen display is corrupted, it means the selected method is not supported. If that happens, return the [Drawing Method] setting to [Software].

## 4. Saving Data

### Saving in Dr. PICZA Format

You can save scanning results in Dr. PICZA format. In Dr. PICZA3, go to the [File] menu and click [Save As]. In addition to Dr. PICZA3, the 3D Editor program for editing 3D data can also open files in this format.

### Exporting Data

In addition to Dr. PICZA format, you can save (export) scanning results in DXF format (3D surfaces), STL format (text or binary), or Point Group format. These are commonly used formats, so you can make use of them to share data with other programs.

1. In Dr. PICZA3, click the [Export] button. Click the file format you want to use for exporting.
2. For STL format, select either text STL or binary STL, then click [OK]. For Point Group format, select the separator character, then click [OK]. Select one supported by the program with which you want to share the data.

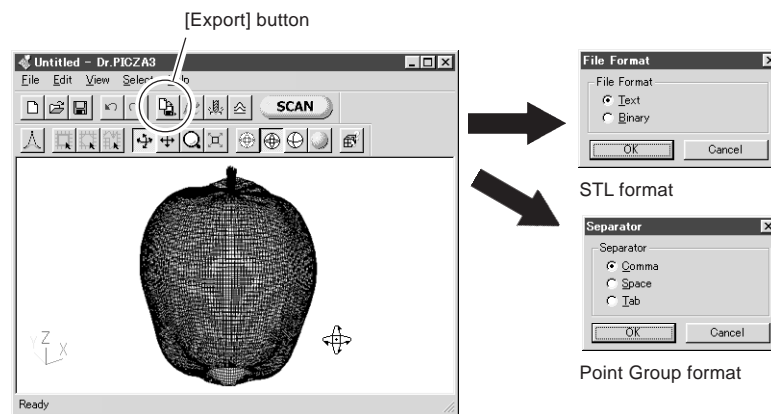

3. Type in the name of the file to export, then click [Save].



In addition to these, the LPX-250 also supports exporting in VRML format, 3DMF format, and (with some restrictions) IGES format. You perform exporting in these formats using the 3D Editor program for editing 3D data.

When you export the results of multi-plane composition, a number of sets of scanning data are merged. When you view data with Dr. PICZA3, however, to speed up the screen display time, this processing is not performed. There is nearly no difference in the display before and after processing, but if you want to check the appearance after merging, open the scanned data in 3D Editor. For more information about 3D Editor, see Part 5 and the 3D Editor User's Manual (electronic-format manual) .

## Part 4

# Features for Better Scanning

## 1. Detailed Settings for Plane Scanning

In addition to the automatic scanning-condition settings, you can also make the settings manually, to any values you like.

### Scanning Using Manual Settings

1. In Dr. PICZA3, click the [SCAN] button. The [Scan] dialog box appears.
2. Click the [Make Settings and Scan] button for plane scanning. The [Settings for Scanning] dialog box appears.
3. Set the scanning conditions, then click the [Scan] button. Scanning starts.

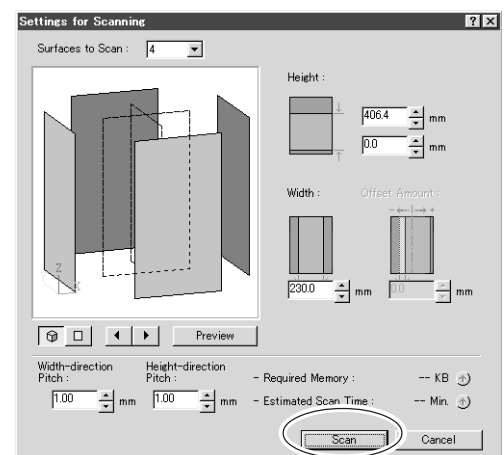
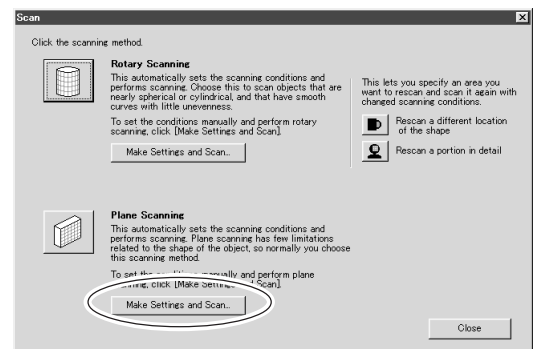

## Detailed Scanning Conditions

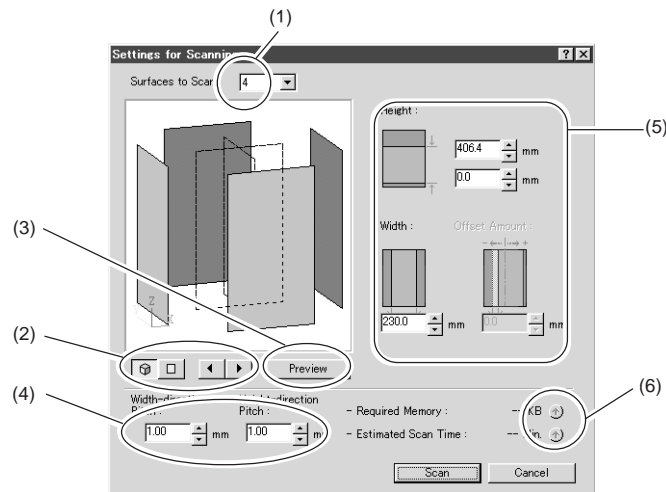

- (1) This sets the number of scanning surfaces. For multi-plane composition, select a number from [2] to [6]. The preview window shows the scanning surfaces.
- (2) This manipulates the orientation that the preview window displays. You can do things like rotating the preview or displaying a three-dimensional view.
- (3) Click this to display a preview of the object. Use this as a guide for setting the scanning area.
- (4) These set the height-direction and width-direction scanning pitch.
- (5) This sets the scanning area. You can make the setting for [Offset Amount] only when the number of surfaces to scan is set to [1].
- (6) Clicking this button displays estimates of the amount of memory required for scanning and the scanning time. Whenever you change the scanning conditions, click this button again.  
Performing scanning that exceeds the amount of free memory of the computer may greatly reduce performance for such tasks as updating the screen display. We recommend installing sufficient memory in the computer when you are performing large-size scanning.



### The Important Point Is to Use the Minimum Required Scanning Area

The smaller the scanning area is, the sooner scanning finishes. You can achieve efficient scanning by making the setting for the minimum area that is required. If you don't actively set the scanning area, the entire scannable area is scanned.

#### Tips for Setting the Scanning Pitch

This settings determines the extent to which detailed portions are reproduced. Smaller (finer) pitches do not make for correspondingly greater smoothness. When extreme detail is not necessary, it can actually be more effective to set a coarse pitch.

#### Units Used by Dr. PICZA3

Dr. PICZA3 can display values in either millimeters or inches. The settings for Windows determine which are used. To change the unit of measurement, follow the steps below. In Windows, open [Control Panels], then double-click [Regional Settings]. At the [Number] tab, select [Measurement system]. Restart Dr. PICZA3.

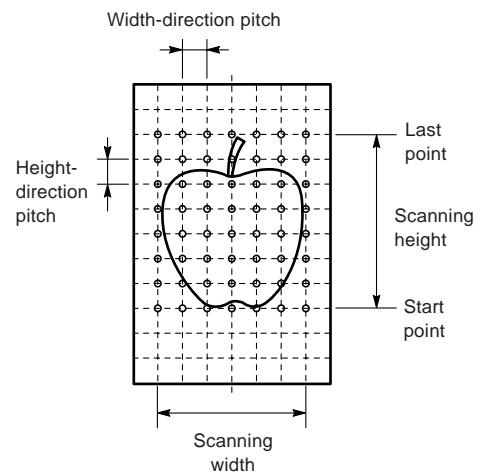

## 2. Detailed Settings for Rotary Scanning

### Scanning Using Manual Settings

1. In Dr. PICZA3, click the [SCAN] button. The [Scan] dialog box appears.
2. Click the [Make Settings and Scan] button for rotary scanning. The [Settings for Scanning] dialog box appears.

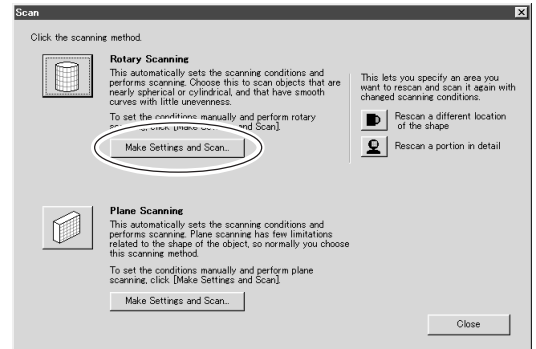

3. Set the scanning conditions, then click the [Scan] button. Scanning starts.

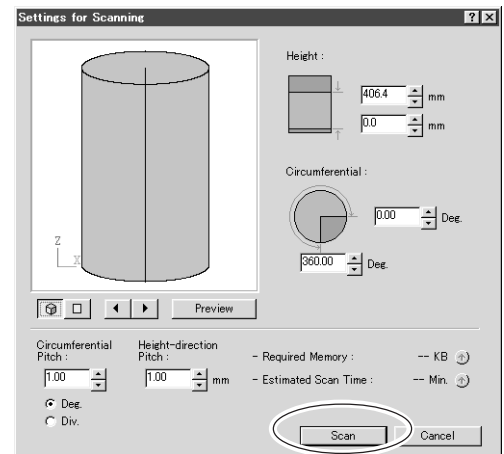

## Detailed Scanning Conditions

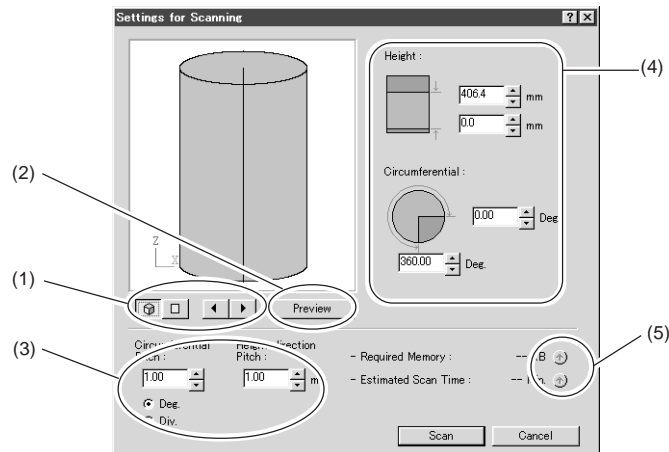

- (1) This manipulates the orientation that the preview window displays. You can do things like rotating the preview or displaying a three-dimensional view.
- (2) Click this to display a preview of the object. Use this as a guide for setting the scanning area.
- (3) These set the circumferential and height-direction scanning pitch. For the unit of measurement for circumferential pitch, you can select either degrees or the number of segments of the circumference (360 degrees).
- (4) This sets the scanning area. Setting [Circumferential] to either [0] or [360] results in scanning of the entire 360-degree circumference.
- (5) Clicking this button displays estimates of the amount of memory required for scanning and the scanning time. Whenever you change the scanning conditions, click this button again.  
 Performing scanning that exceeds the amount of free memory of the computer may greatly reduce performance for such tasks as updating the screen display. We recommend installing sufficient memory in the computer when you are performing large-size scanning.



### Scanning Area and Scanning Pitch

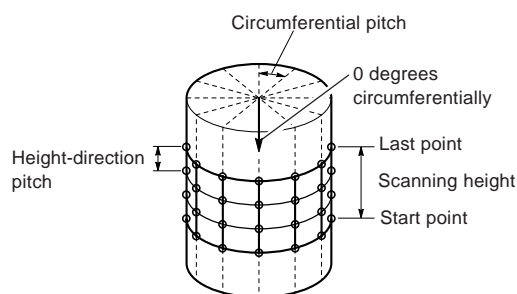

Oriented 0 degrees circumferentially

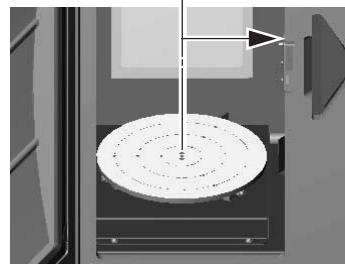

## 3. Finishing Detailed Areas Using Rescanning

After you have scanned an entire object, this feature rescans just one portion with changed conditions. Basic scanning should always be performed using the best possible conditions, of course, but by using rescan to finish detailed portions you can make the data even more highly finished. Rescanning is effective only when you used rotary scanning to perform the basic scanning.

### Finishing Areas That Could Not Be Scanned

Depending on the conditions, rotary scanning may produce results like those described below. However, you can perform finishing by using rescanning. This is a feature that lets you do scanning over again in the plane-scanning mode for the portion you want to finish. Note that you cannot expect any benefits from rescanning in cases such as those where the shape of the object blocks the laser beam no matter how the object is oriented.

#### Areas joined because the laser light does not reach

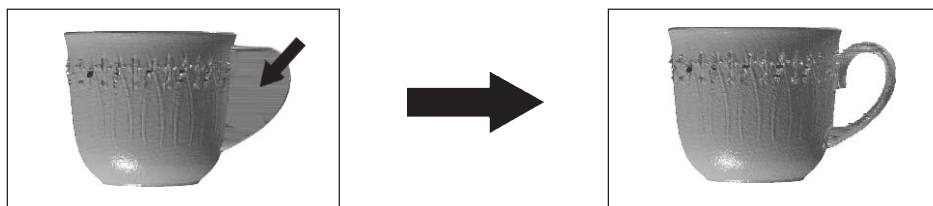

#### Areas with holes due to surface drop-out

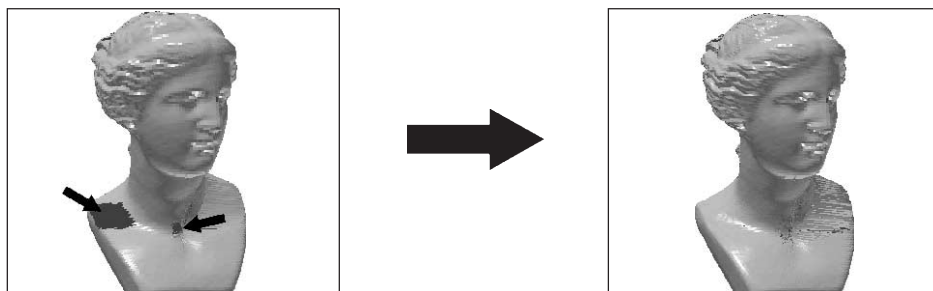

1. First, use rotary scanning to scan the entire object. From this point on, until rescanning is finished, the mounted position of the scan object must not be moved.
2. When you have finished scanning the entire object, click the [Scan] button. A dialog box appears.
3. Click [Rescan a different location of the shape]. The Controller appears.

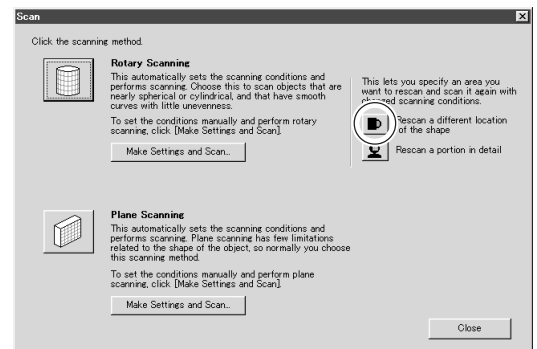

4. Hold down the SPACE key and drag to position the area you want to rescan at the front. This makes the front surface the direction of laser-beam emission. As you determine the orientation, try to angle it so that the laser light can penetrate sufficiently (or so that the laser light passes through).

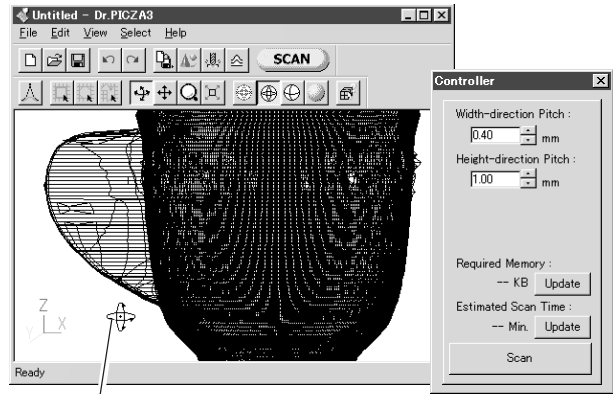

SPACE key + drag left or right to shift the perspective.

5. Drag (without holding down any keys) to specify the rescanning area. The direction of plane scanning is determined by the on-screen orientation at this time.
6. You can specify more than one rescanning area. To do this, repeat steps 4 and 5. The scanning orientations are as you specify in step 5, resulting in scanning in more than one direction. (Note, however, that the scanning pitch is identical for all directions.)
7. Enter a finer scanning pitch as required, then click [Scan].

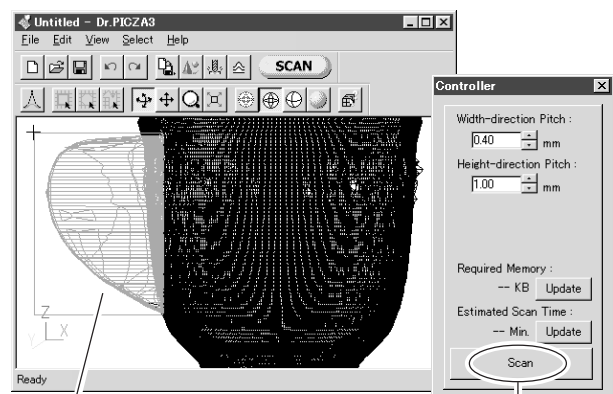

Drag to select the area to rescan.

This executes rescanning.



#### Shortcut Keys for Shifting the Perspective

You can also use the arrow keys to shift the perspective when specifying the rescanning area. Also, you can shift in parallel or zoom in or out by holding down the CTRL key or the SHIFT key while dragging.

#### Specifying an Area and Rescanning

Clicking anywhere on the object after you have specified the rescanning area releases the area you specified. Also, even if you have performed rescanning, you can return to the state before rescanning by using the [Undo] button.



[Undo] button

#### Rescanning and the Scanning Pitch

When you are creating a void, as in the example of the coffee cup, it may be a good idea to make the scanning pitch somewhat finer. When you want to a void or cavity in detail, it is effective to make the scanning-pitch values smaller than the size of the void.

## Scanning a Specific Area in Greater Detail

You perform coarse scanning of the entire object using rotary scanning, then rescan just the required areas at a finer pitch. This can reduce the size of the data and also shorten the scanning times. This feature is for rescanning a portion in the rotary-scanning mode.

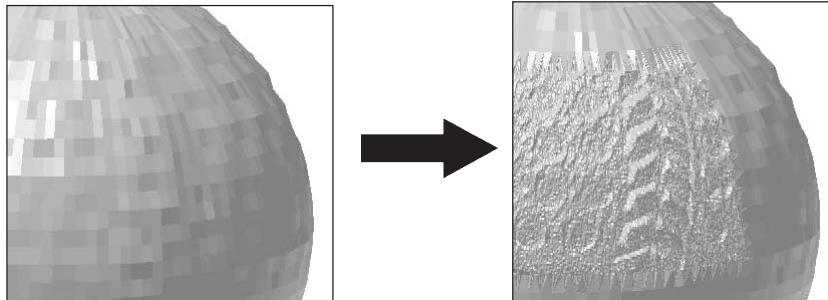

1. First, use rotary scanning to scan the entire object. From this point on, until rescanning is finished, the mounted position of the scan object must not be moved.
2. When you have finished scanning the entire object, click the [SCAN] button. A dialog box appears.
3. Click [Rescan a portion in detail]. The Controller appears.
4. Hold down the SPACE key and drag to position the area you want to rescan at the front.
5. Drag (without holding down any keys) to specify the rescanning area. You can specify more than one scanning area.
6. Enter a finer scanning pitch, then go to the Controller and click [Scan]. Rescanning starts.

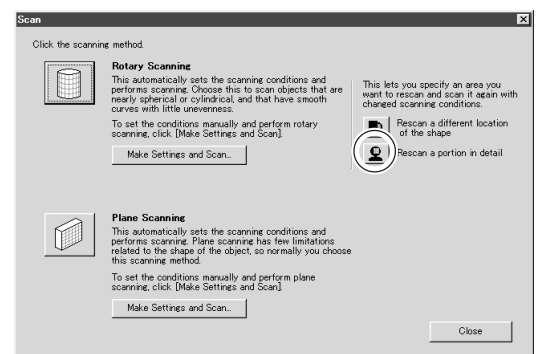

7. You can check and verify the scanning results in greater detail by using 3D Editor. Click [Run 3D Editor] to start the program and display the scanning results.

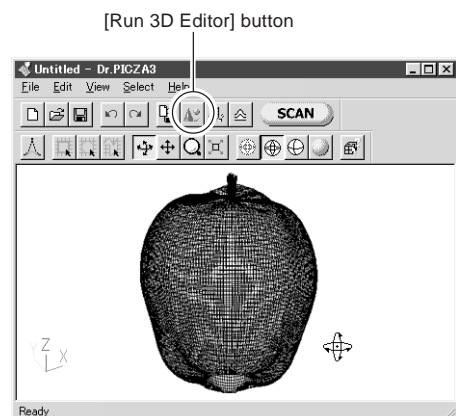

### Viewing Scanning Results Using 3D Editor

Processing to merge multiple sets of scanning data is performed when you export these scanning results, but to speed up display, no processing is performed when you display the results with Dr. PICZA3. This means that the view that Dr. PICZA3 shows may differ slightly from the results after merging. If you want to check the appearance after merging, use 3D Editor to open the data you scanned. For more information about 3D Editor, see Part 5 and the 3D Editor User's Manual (electronic-format manual).

## 4. Case Studies for Better Scanning

### Scanning Results for Objects That Are Difficult to Scan

These are some examples of scans of difficult materials. (The plated object was specially scanned for experimental purposes only. Avoid highly reflective objects because of danger of eye injury.)

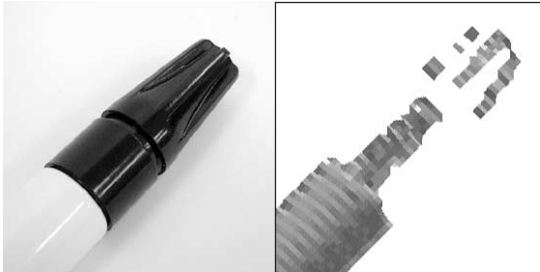

**Black marker pen**  
Plane scanning  
Pitch: 1.0 mm x 1.0 mm

Scanning errors occurred at black areas.



**Plated object**  
Rotary scanning  
Pitch: 1.0 mm x 3 degrees

\* In these cases, applying a white surfacer (primer) or the like may yield good results.

### Choosing the Scanning Mode

This example involves using the two scanning modes to scan an object that has cavities and a complex shape. Plane scanning is suited to objects like this.

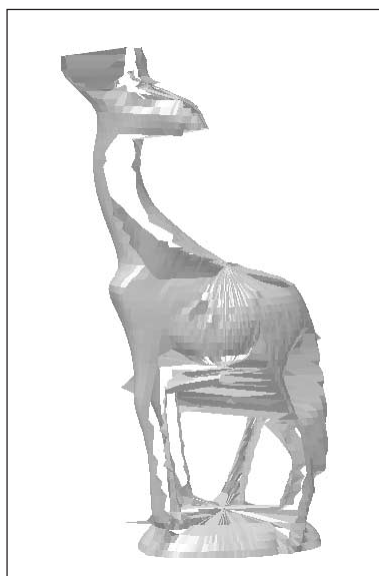

**Rotary Scan**

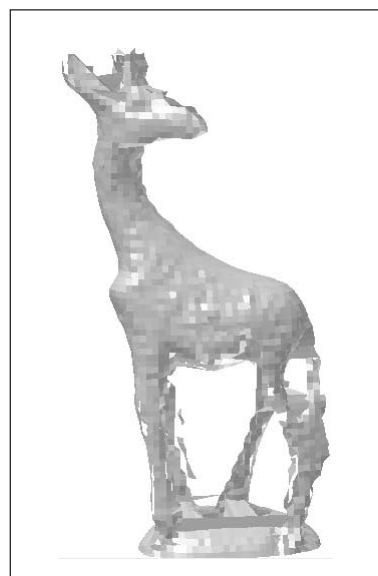

**Plane Scan**

This example involves using the two scanning modes to scan an object that has a nearly cylindrical shape. You can use either mode for scanning, but rotary scanning achieves the shortest scanning times. The scanning pitch is equivalent for both, but rotary scanning produces smoother surfaces.



**Rotary scanning**

Pitch of 1.4 mm x 1.6 degrees  
Scanning time of 3 minutes 30 seconds



**Plane scanning**

Pitch of 1.4 mm x 1.4 mm  
Scanning time of 6 minutes

This is an example of an object finished using rescanning after rotary scanning and an object scanned using plane scanning. To determine which of the two modes to use, you should decide how much you want to take advantage of the features of rotary scanning. Using plane scanning eliminates the need to perform rescanning, but if smooth curves are important, then rotary scanning may be more effective.



**Rotary scanning  
(with finishing by rescanning)**



**Plane scanning  
(four scanning surfaces)**

## The Scanning-start Direction for Plane Scanning

This is an example where the scanning-start direction is changed with plane scanning. It is a good idea to give thought to the direction in which cavities and voids can be most easily captured (that is, the direction in which the laser beam passes), and also to keep in mind what area of the object is most important.



Example of starting from the front surface  
(two scanning surfaces)

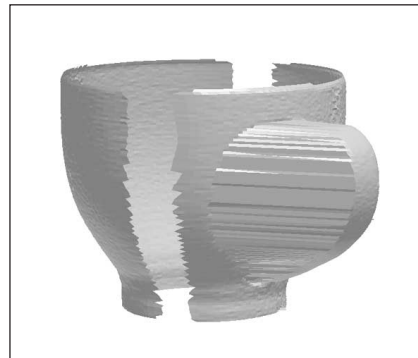

Example of starting from the front at an angle  
(two scanning surfaces)

## Object Mounting Location for Rotary Scanning

In rotary scanning, the laser light is beamed toward the center of the table. This means that when the object is uneven, the penetration of the laser light varies greatly according to the object's mounting location. This case takes this point into account and deliberately shifts the mounted position away from the center. Note that plane scanning may be better suited to an object like this one. At this mounted position, the back portion is not scanned correctly.

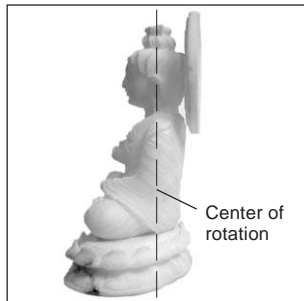

**Plaster figure**

Rotary scanning  
Pitch: 0.6 mm x 1.0 degree

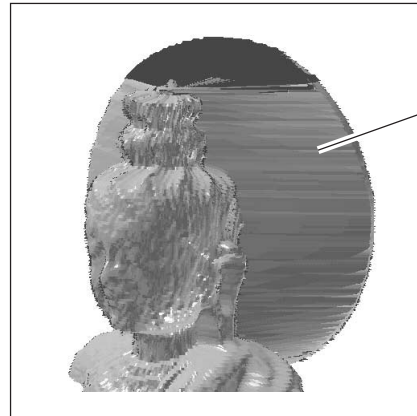

Depression is a dead angle for laser light, and so is not scanned.

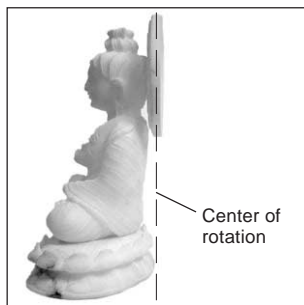

**Plaster figure**

Mounting position changed under the same conditions.

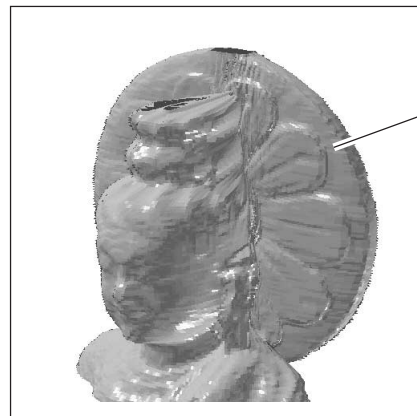

Scanning of the depression is enhanced.

# Part 5

## Editing Scanning Results–Using 3D Editor

### 1. What You Can Do Using 3D Editor

3D Editor lets you do things like the following.

<b>Enlarge and reduce</b>	Deforming operations such as stretching in one direction are also possible.
<b>Move and rotate</b>	Specifying numerical values for the movement distance and angle of rotation is also possible.
<b>Sever</b>	You can divide an object into parts. Filling cut surfaces is also possible.
<b>Delete</b>	You can delete unneeded objects.
<b>Merge</b>	You can unite a number of objects. There is even an alignment feature for doing this.
<b>Reduce the number of polygons</b>	This reduces the amount of data while keeping detail. This is an essential feature of 3D scanners.
<b>Smoothing feature</b>	This smooths the surfaces of objects.
<b>Export</b>	Data can be saved in such formats as DXF, STL, IGES, VRML, and Point Group.

The features of 3D Editor are described in detail in the "3D Editor User's Manual" (electronic-format manual). Refer to it as well. Note that 3D Editor can only work with surface models.

### 2. Importing and Exporting Data

#### Importing Scanning Results Immediately

In Dr. PICZA3, clicking the [Run 3D Editor] button starts 3D Editor and simultaneously imports the displayed scanning results.

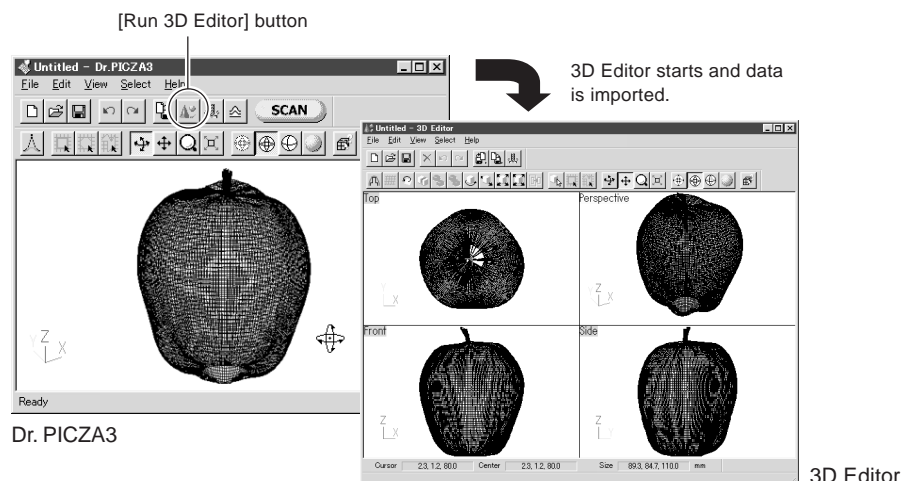

## Importing More Than One Set of Data

You can use the [Import] button to import more than one set of data and place a number of object in the 3D Editor window. You can import Dr. PICZA-format files, DXF-format files (3D surface models only), and STL-format files.

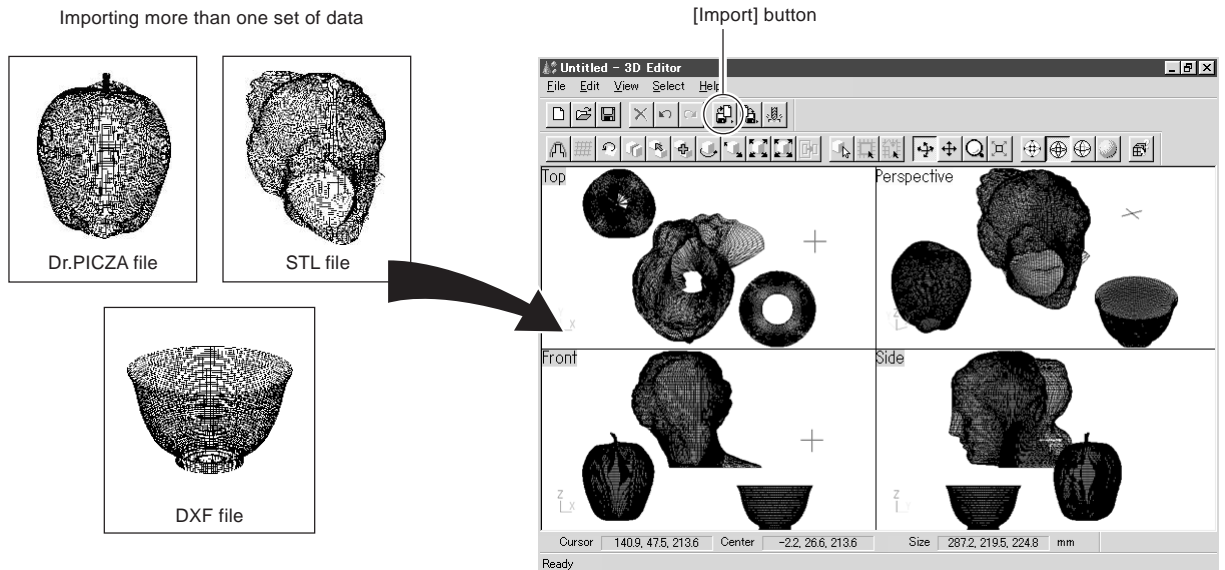

3D Editor, Dr. PICZA3 also supports importing for Dr. PICZA-format files from Dr. PICZA versions 1 through 2.

## Exporting Data in Other Formats

You can use the [Export] button to save data in a wide variety of formats, including DXF, STL, IGES, VRML, and Point Group.

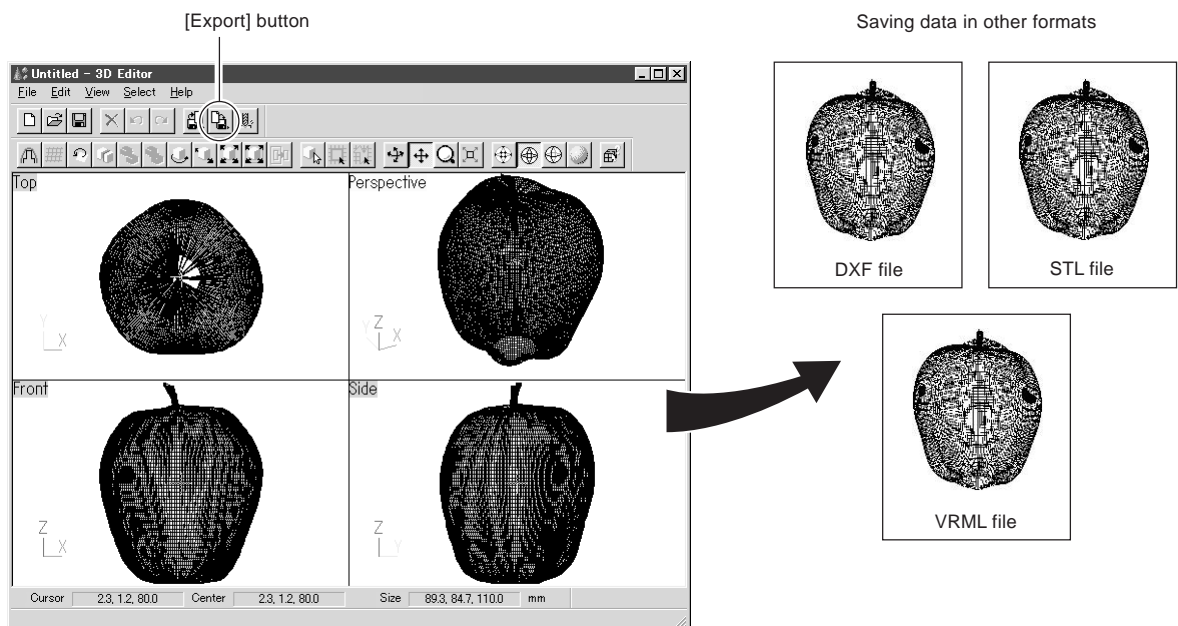

## 3. Basic Operations for Objects

### How to View the 3D Editor Window

3D Editor displays an object from four different perspectives at the same time. You can manipulate any one of these at any time. The important point is that you get four different views from four angles. However, each of the four windows has its own features.

#### Top

This is a view of the object seen from directly above. You can move only in the X and Y directions; there is no movement in the Z-axis direction. Use this at times such as when you want accurate movement in only the X and Y directions.

#### Perspective

You can move in all three directions (X, Y, and Z). Operations such as accurate movement in the X-axis direction are difficult, and there is no way to tell how much movement is made in the X, Y, and Z directions. It may be a good idea to use this mainly as a viewer to visualize the entire object.

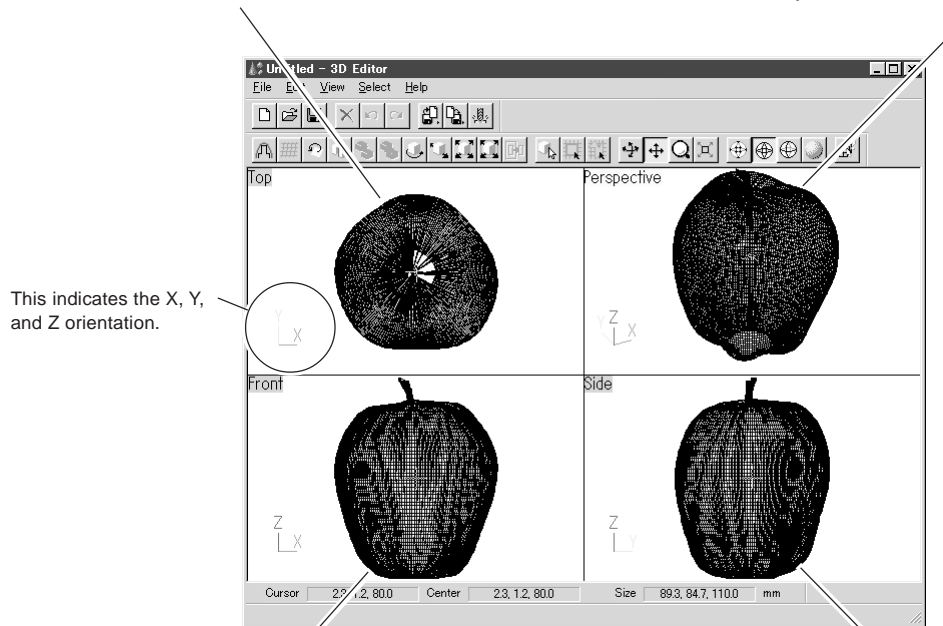

#### Front

This is a view of the object seen from directly in front. You can move only in the X and Z directions; there is no movement in the Y-axis direction. Use this at times such as when you want an accurate view of movement along the Z axis.

#### Side

This is a view of the object seen directly from the side. You can move only in the Y and Z directions; there is no movement in the X-axis direction. Use this at times such as when you want an accurate view of movement along the Z axis.

## Let's Try Editing Data with 3D Editor

Let's try some simple editing. We'll scan an apple with the LPX-250, then try cutting and moving it.

1. First, do a scan of an apple. Then, in Dr. PICZA3, click the [Run 3D Editor] button. When 3D Editor starts, the data for the apple is imported at the same time.

[Run 3D Editor] button

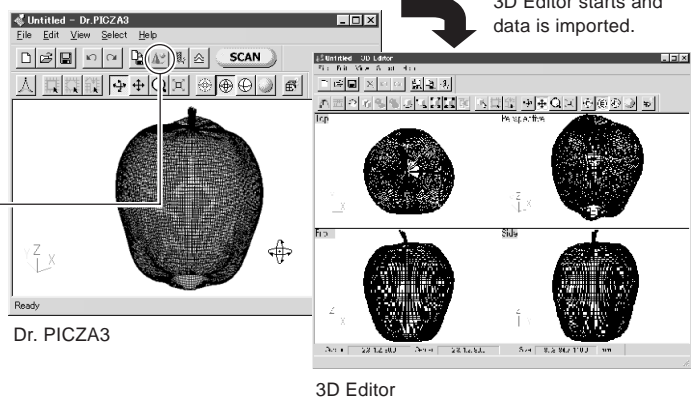

2. Try cutting the apple vertically. Clicking the [Cut at Plane] button displays the cut surface and a dialog box.

[Cut at Plane] button

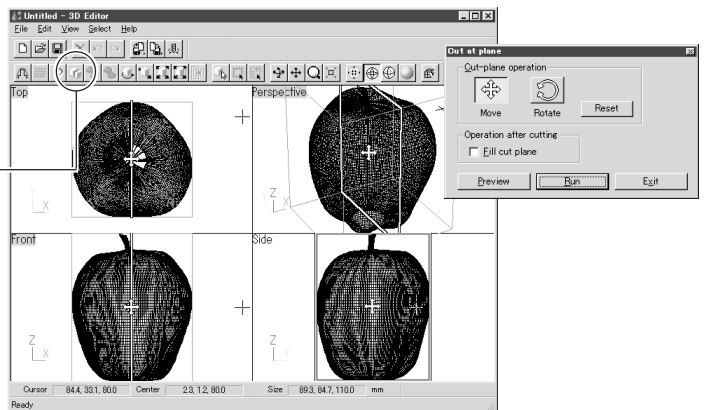

3. Try shifting the cut location a little to one side. This may be easiest to do in the [Front] window. Drag the cut surface to move it to the left.

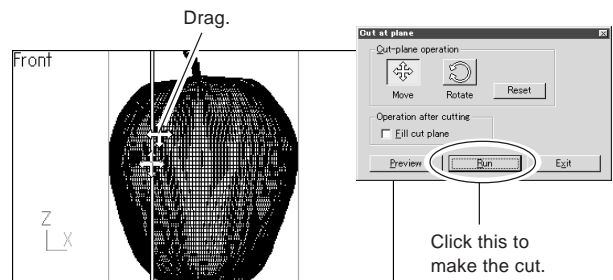

4. When you have decided on the cut location, click [Run]. The apple is divided into two parts. However, it still looks like a single object. Try separating the two parts. Click the [Select Object] button, then click the left part of the apple to select it.

[Select Object] button



Click this portion to select it.

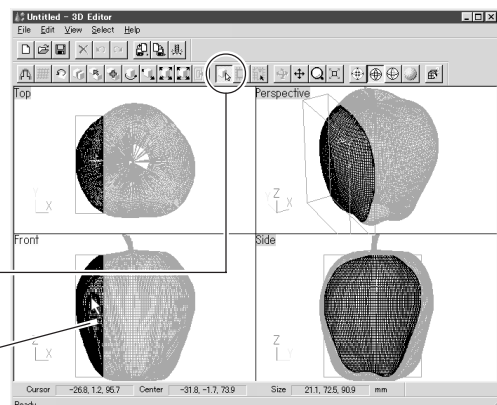

- Click the [Move Object] button, then drag the portion you selected to the left. The two parts separate. When you're done with the operation, right-click to quit the [Move Object] mode.

[Move Object] button 

Drag the object you want to move.

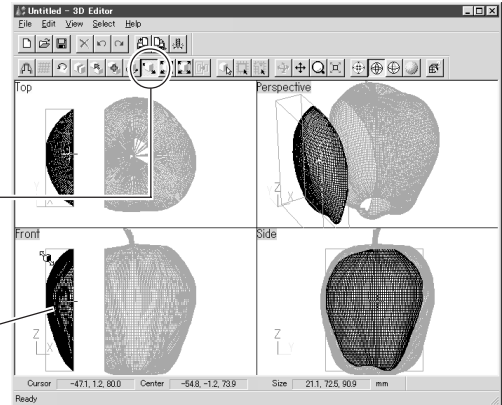

- Now try orienting the cut surface of the apple on the right to face the front. You can only do this when you're in the [Top] window. First click the [Select Object] button, then click the right side of the apple to select it.

Click this portion to select it.

[Select Object] button 

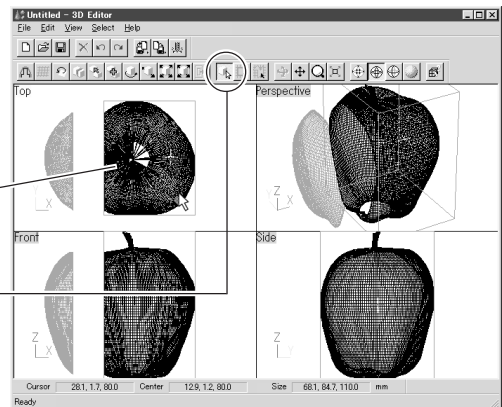

- Click the [Rotate Object] button, then drag to turn the object counterclockwise. Try turning it until the cut surface faces down. Look at the [Perspective] window to see how the cut surface faces the front. When you're done with the operation, right-click to quit the [Rotate Object] mode.

[Rotate Object] button 

Drag to rotate.

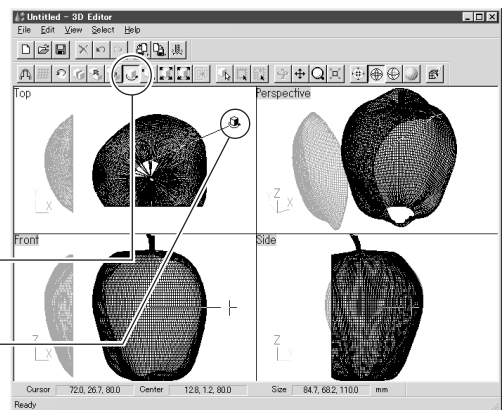

- Finally, try deleting the cut part. You can do this in any window except the [Side] window. First click the [Select Object] button, then click the cut-off portion to select it. Then click the [Erase] button.

[Erase] button 

[Select Object] button 

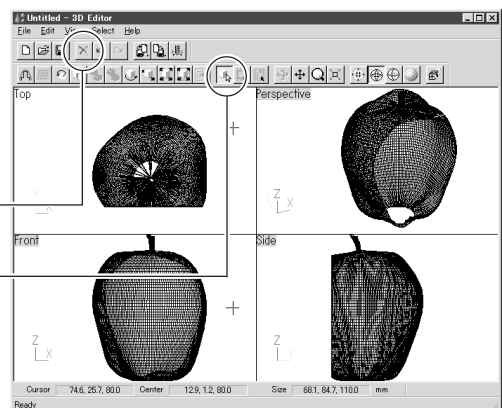

# Part 6

## Troubleshooting

If operation is not as expected, try taking corrective action as described below. If that doesn't correct the problem, or if you determine that there is a breakdown, then contact your authorized Roland DG Corp. dealer or service center.

Symptom	Remedy	If the problem persists
<b>The power does not come on when the Standby key is pressed.</b>	<ul style="list-style-type: none"><li>- Make sure the AC adapter and power cord are connected correctly.</li><li>- Unplug the AC adapter from the electrical outlet, redo the connections, then press the Standby key.</li></ul>	The scanner unit or the AC adapter may be broken, or there may be a broken wire in the power cord.
<b>The power does not go off when the Standby key is held down for 1 second or longer.</b>	<ul style="list-style-type: none"><li>- Unplug the AC adapter from the electrical outlet.</li></ul>	
<b>When the power is turned on an unusual sound is heard for about 40 seconds.</b>	<ul style="list-style-type: none"><li>- Make sure all the head retainers have been removed.</li><li>- Make sure no scan objects or other items are caught inside the machine.</li></ul>	The scanner may be broken.
<b>When the power is switched on the Standby key lights up green, but scanning cannot be performed.</b>	<ul style="list-style-type: none"><li>- Make sure all the head retainers have been removed.</li><li>- Make sure the correct COM port number is set in the preferences for Dr. PICZA3.</li><li>- Restart the computer.</li><li>- Make sure the connection to the computer is correct.</li><li>- Unplug the scanner's AC adapter from the electrical outlet, redo the connections, then switch on the power.</li></ul>	The cable used for the connection with the computer may not be the right kind or may be broken. Alternatively, the computer's COM port may not be functioning, or the scanner unit may be broken.
<b>When the power is switched on the Standby key flashes green and there is no movement at all.</b>	<ul style="list-style-type: none"><li>- Close the door securely.</li><li>- Unplug the AC adapter from the electrical outlet, redo the connections, then switch on the power.</li></ul>	The scanner may be broken.
<b>The Standby key flashes orange and scanning cannot be performed.</b>	<ul style="list-style-type: none"><li>- First start the computer, then switch on the power to the scanner unit.</li><li>- Restart the computer, then reset the power to the scanner unit.</li><li>- Unplug the scanner's AC adapter from the electrical outlet, redo the connections, then switch on the power.</li><li>- Make sure the right kind of cable is used for the connection with the computer.</li><li>- Reinstall the program.</li></ul>	The cable used for the connection with the computer may be faulty or there may be faulty contact at one of the connectors.
<b>The Standby key flashes (or lights up) red.</b>	<ul style="list-style-type: none"><li>- Unplug the AC adapter from the electrical outlet, redo the connections, then switch on the power.</li></ul>	The scanner may be broken.
<b>Scanning ended, but the computer then stopped.</b>	<ul style="list-style-type: none"><li>- Scanning that exceeds the amount of free memory in the computer may drastically impair the performance of the computer. In Dr. PICZA3, go to the [Settings for Scanning] dialog box and check the amount of required memory, and consider increasing the scanning pitch or installing more memory.</li></ul>	

Symptom	Remedy	If the problem persists
<p><b>The message "Cannot communicate with present scanner" appears on the computer and there is no operation.</b></p>	<ul style="list-style-type: none"> <li>- Switch on the power to the scanner before you run Dr. PICZA3.</li> <li>- Make sure the correct COM port number is set in the preferences for Dr. PICZA3.</li> <li>- Restart the computer.</li> <li>- Make sure the connection to the computer is correct.</li> <li>- Unplug the scanner's AC adapter from the electrical outlet, redo the connections, then switch on the power.</li> <li>- Reinstall the program.</li> </ul>	<p>The cable used for the connection with the computer may not be the right kind or may be broken. Alternatively, the computer's COM port may not be functioning, or the scanner unit may be broken.</p>
<p><b>The message "COM:** not ready" appears on the computer.</b></p>	<ul style="list-style-type: none"> <li>- Restart the computer.</li> <li>- Unplug the scanner's AC adapter from the electrical outlet, redo the connections, then switch on the power.</li> <li>- If you're using Windows NT/2000 make sure no other printer driver or the like is using the same COM port.</li> <li>- Reinstall the program.</li> </ul>	
<p><b>The message "Can't find MODELA Player" or "Can't find 3D Engrave" appears on the computer.</b></p>	<ul style="list-style-type: none"> <li>- The buttons for running these do not function on this system. They become available when you are using together with the MODELA series or the like.</li> </ul>	

# Part 7

## Appendix

### 1. Sample Data Sheet

This is a data sheet from an actual scan. Refer to it when you are setting scanning conditions.



<b>Object</b>	Material: plaster	
<b>Scanning mode</b>	Rotary scanning	
<b>Scanning area</b>	Height direction 0 to 325 mm, Circumferential 0 to 360 degrees	
<b>Scanning pitch</b>	Height direction 1.0 mm, Circumferential 1.0 degrees	
<b>Scanning time</b>	Approx. 27 minutes	
<b>Memory used</b>	Approx. 38 MB (estimate of use by Dr.PICZA3)	
<b>Data size</b>	Dr. PICZA format (text)	5.1 MB
	DXF format	22.6 MB
	STL text format	62.0 MB
	STL binary format	10.8 MB
	IGES format	458 KB (portion of bust front; 5,400 control points)
	VRML format	5.8 MB
	3DMF format	5.7 MB
<b>Computer</b>	Windows 98, PentiumIII 450 MHz, 128 MB RAM	

## 2. Table Dimensional Drawing

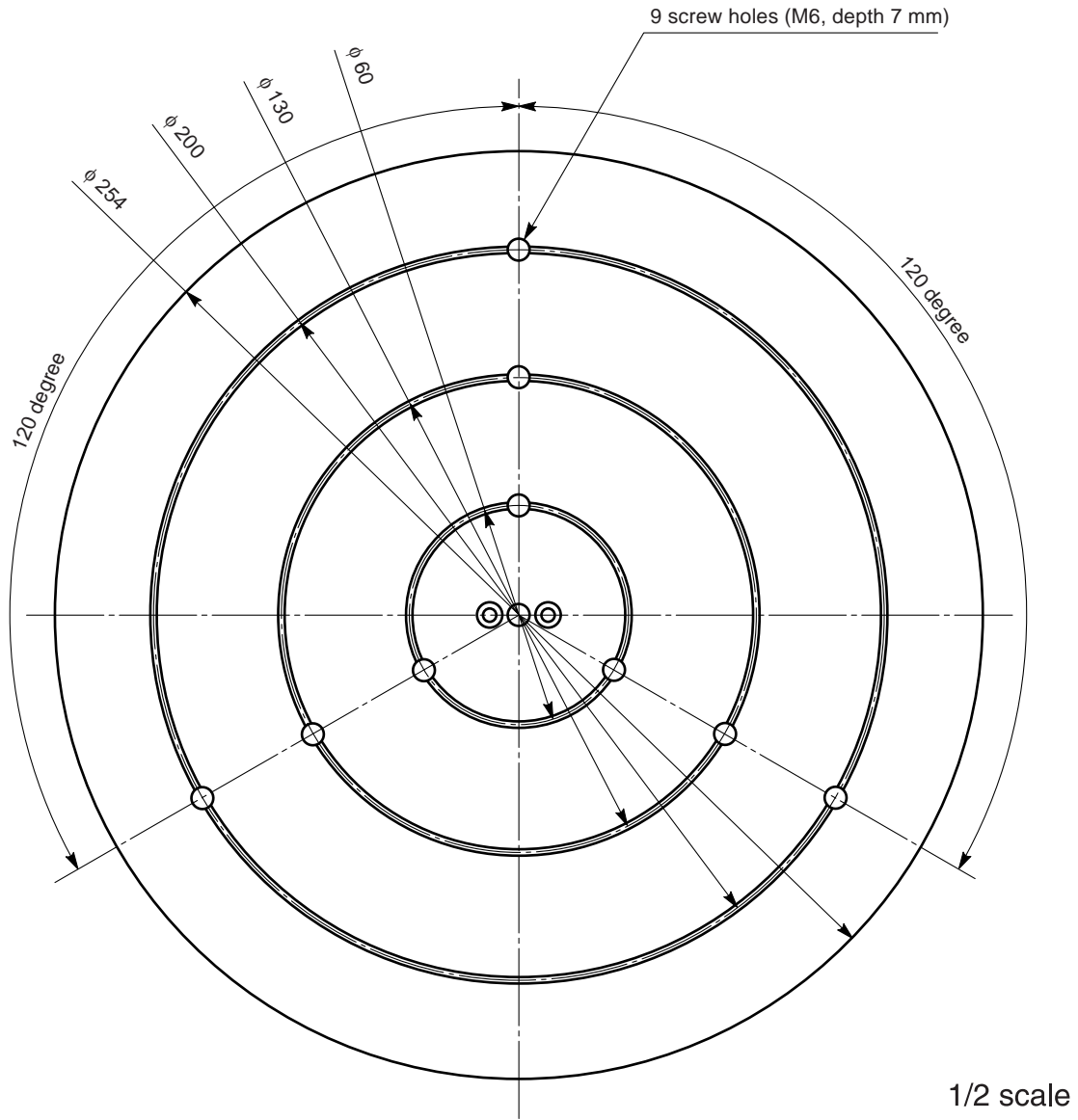

## 3. Specifications

<b>Table size</b>	Diameter 254 mm (10 in.)
<b>Maximum scanning area</b>	Rotary scanning: Diameter 254 mm (10 in.), height 406.4 mm (16 in.) Plane scanning: Diameter 230 mm (9 in.), height 406.4 mm (16 in.)
<b>Scanning pitch</b>	Rotary scanning: circumference 0.2 to 60 degrees, height direction 0.2 to 406.4 mm Plane scanning: width direction 0.2 to 230 mm, height direction 0.2 to 406.4 mm
<b>Maximum table load weight</b>	5 kg (11 lb.) (not including optional vise)
<b>Laser</b>	Wavelength: 600 to 700 nm, maximum output: less than 1.0 mW (maximum output discharged outside housing is 0.39 $\mu$ W), pulse width: 350 $\mu$ s, pulse frequency: 2,857 Hz
<b>Sensor</b>	Noncontact laser sensor
<b>Scanning method</b>	Spot-beam triangulation
<b>Operating speed</b>	Table rotation speed: 15 rpm, head rotation speed: 7.5 rpm, head movement speed: 50 mm/sec.
<b>Interface</b>	Serial (RS-232C standard, D-Sub 25 pin) Transfer method: Asynchronous/full duplex data communication, 9,600/115,200 bps transfer speed, 8 data bits, 1 stop bit, no parity, hardware flow control
<b>Control keys and LEDs</b>	Standby key, Standby LED, and Movement LEDs
<b>Power consumption</b>	Dedicated AC adapter (DC 19 V, 2.1 A)
<b>External dimensions</b>	528 (W) x 742 (D) x 431 (H) mm (20-13/16 (W) x 29-3/16 (D) x 16-15/16 (H) in.)
<b>Weight</b>	32 kg (70.5 lb.) (main unit only)
<b>Operating temperature</b>	10 to 40 °C (50 to 104 °F)
<b>Operating humidity</b>	35 to 80% (no condensation)
<b>included items and accessories</b>	AC adapter: 1, power cord: 1, 2.5-mm hexagonal wrench: 1, 3-mm hexagonal wrench: 1, caps: 3, Roland Software Package CD-ROM: 1, user's manual: 1, Roland Pixform™: 1

### Serial connector (RS-232C)

Signal number	Terminal number	Signal number	Pin connection
NC	25	13	NC
NC	24	12	NC
NC	23	11	NC
NC	22	10	NC
NC	21	9	NC
DTR	20	8	NC
NC	19	7	SG
NC	18	6	DSR
NC	17	5	CTS
NC	16	4	RTS
NC	15	3	RXD
NC	14	2	TXD
	1		FG

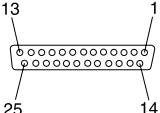

### XY-RS-34/14 cable connection

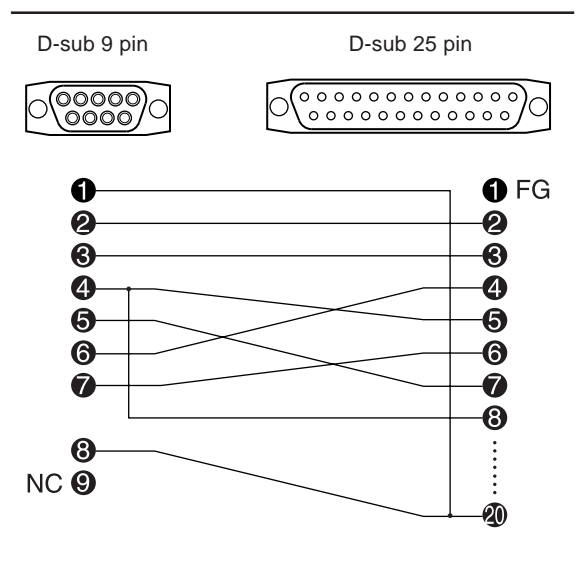

**Please read this agreement carefully before opening the sealed package or the sealed disk package**

Opening the sealed package or sealed disk package implies your acceptance of the terms and conditions of this agreement.

<b>Roland License Agreement</b>	
Roland DG Corporation ("Roland") grants you a non-assignable and non-exclusive right to use the COMPUTER PROGRAMS in this package ("Software") under this agreement with the following terms and conditions.	
1. Coming into Force	<p>This agreement comes into force when you purchase and open the sealed package or sealed disk package.</p> <p>The effective date of this agreement is the date when you open the sealed package or sealed disk package.</p>
2. Property	<p>Copyright and property of this Software, logo, name, manual and all literature for this Software belong to Roland and its licensor.</p> <p>The followings are prohibited :</p> <ul style="list-style-type: none"><li>(1) Unauthorized copying the Software or any of its support file, program module or literature.</li><li>(2) Reverse engineering, disassembling, decompiling or any other attempt to discover the source code of the Software.</li></ul>
3. Bounds of License	<p>Roland does not grant you to sub-license, rent, assign or transfer the right granted under this agreement nor the Software itself (including the accompanying items) to any third party.</p> <p>You may not provide use of the Software through time-sharing service and/or network system to any third party who is not individually licensed to use this Software.</p> <p>You may use the Software by one person with using a single computer in which the Software is installed.</p>
4. Reproduction	<p>You may make one copy of the Software only for back-up purpose. The property of the copied Software belongs to Roland.</p> <p>You may install the Software into the hard disk of a single computer.</p>
5. Cancellation	<p>Roland retains the right to terminate this agreement without notice immediately when any of followings occurs :</p> <ul style="list-style-type: none"><li>(1) When you violate any article of this agreement.</li><li>(2) When you make any serious breach of faith regarding this agreement.</li></ul>
6. Limitations on Liability	<p>Roland may change the specifications of this Software or its material without notice.</p> <p>Roland shall not be liable for any damage that may caused by the use of the Software or by exercise of the right licensed by this agreement.</p>
7. Governing Law	<p>This agreement is governed by the laws of Japan, and the parties shall submit to the exclusive jurisdiction of the Japanese Court.</p>